

ABS Digimatic Caliper

IP67 ABS Coolant Proof Caliper

User's Manual

No. 99MAD030A
Date of publication: July 1, 2021 (1)

Safety Precautions

To ensure operator safety, use this product according to the directions, functions and specifications given in this User's Manual. Use under other conditions may compromise safety.

⚠ WARNING Indicates a potentially hazardous situation which, if not avoided, could result in death or serious injury.

- Always keep batteries out of reach of children, and if swallowed, consult a physician immediately.
- Batteries should never be short-circuited, disassembled, deformed or come in contact with extreme heat or flames.
- If alkaline liquid contained in the battery does come in contact with your eyes, flush them immediately with plenty of clean water and consult a physician. If the liquid adheres to the skin or clothes, immediately flush it with plenty of clean water.
- Do not measure the workpiece if it is rotating. There is a risk of injury due to being caught in the machine, etc.

⚠ CAUTION Indicates a potentially hazardous situation which, if not avoided, may result in minor or moderate injury.

- The outside and inside measuring jaws of this caliper have sharp edges. Handle it with great care to avoid injury.

■ Conventions and wording indicating prohibited and mandatory actions



Indicates concrete information about prohibited actions.



Indicates concrete information about mandatory actions.

Contents

1	Type and Code Number.....	2	10	Errors and Countermeasures.....	7
2	Names of Components.....	2	11	Precautions after Use.....	7
3	Precautions for Use.....	3	12	Specifications	7
4	Product Applications.....	3	13	Standard Accessories	8
5	Basic Usage.....	3	14	Optional Accessories	8
6	Confirmation before Measurement..	3	15	Output Specifications	8
7	Installing the Battery and Setting the Origin	4			
8	In/mm Conversion	4			
9	Measurement Method.....	5			

1. Type and Code Number

■ Standard type: with output function and thumb roller

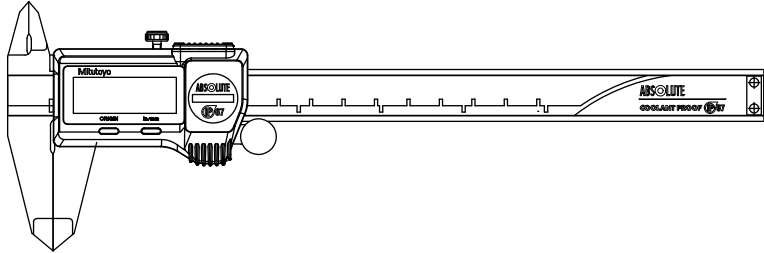

Code No.	500-712-20	500-713-20	500-714-20	500-719-20*	500-762-20
	500-763-20	500-764-20	500-768-20	500-769-20*	

*Depth bar: $\varnothing 1.9$ mm rod

● Model with carbide-tipped jaws for outside measurement

Code No.	500-721-20	500-722-20	500-731-20*	500-732-20*	500-735-20
	500-736-20				

*without output function

● Model with carbide-tipped jaws for outside and inside measurement

Code No.	500-723-20	500-724-20	500-733-20*	500-734-20*	500-737-20
	500-738-20				

● Model without output function

Code No.	500-702-20	500-703-20	500-704-20	500-752-20	500-754-20
	500-768-20*				

*Depth bar: $\varnothing 1.9$ mm rod

● Model without thumb roller

Code No.	500-716-20	500-717-20	500-718-20
----------	------------	------------	------------

● Model without output function and thumb roller

Code No.	500-706-20	500-707-20	500-708-20
----------	------------	------------	------------

2. Names of Components

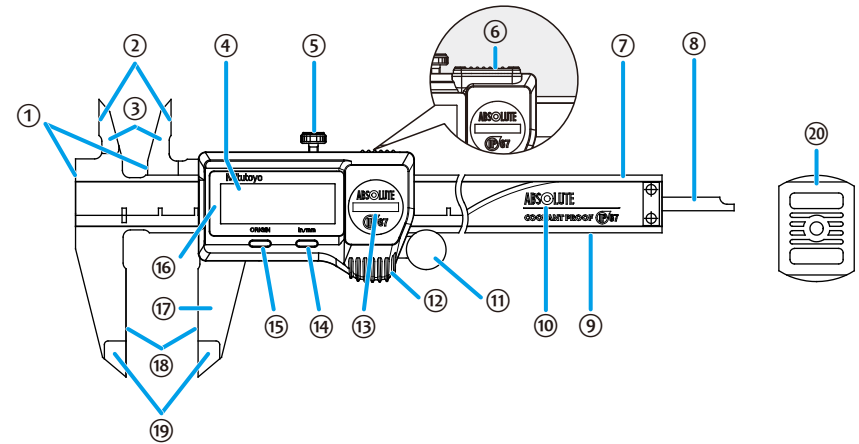

- | | |
|---|--|
| ① Step measuring surface | ⑪ Thumb roller (only for the type with the thumb roller) |
| ② Inside measuring surface | ⑫ Thumb rest |
| ③ Inside measuring jaws | ⑬ Battery lid |
| ④ LCD part | ⑭ [in/mm] switch (only for the model using inches) |
| ⑤ Slider clamp screw | ⑮ [ORIGIN] switch |
| ⑥ Connector cap (only for the model with the output function) | ⑯ Module part |
| ⑦ Beam | ⑰ Slider |
| ⑧ Depth bar | ⑱ Outside measuring surface |
| ⑨ Sliding surface (reference surface) | ⑲ Outside measuring jaws |
| ⑩ Scale | ⑳ Battery lid key |

3. Precautions for Use

NOTICE

Indicates a potentially hazardous situation which, if not avoided, may result in property damage.



- Do not use an electric engraver to put marks on the product such as numbers.
- Do not drop the product or apply excessive force to it.
- Do not scratch the main scale surface.



- Keep the operation temperature and storage temperature.
- After use, take corrosion prevention measures. Corrosion can cause the product to malfunction.
- If the product will not be used for more than three months, remove the battery from and store it properly. Otherwise, liquid may leak from the battery and damage the product.
- For protecting the detection/display module from dust and water sufficiently, tighten the setscrews to secure the battery compartment lid. Also do not remove the packing seal.

- - Before using this product for the first time, wipe the rust preventive oil from the product with a soft cloth soaked with cleaning oil, and install the supplied battery.
- - If rust preventive oil is dried, the product might not operate smoothly. Wipe a sliding surface with a cloth and then apply a little oil to use the product. This can make the product operate smoothly.

4. Product Applications

Outside measurement

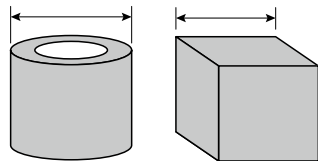

Inside measurement

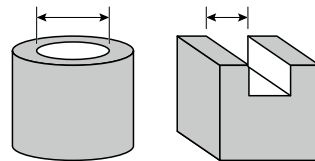

Step measurement

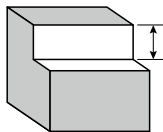

Depth measurement

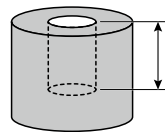

5. Basic Usage

Using the caliper

Grasp the beam lightly with your right hand, put your right thumb on the thumb rest, and move the slider horizontally to measure.

Fixing the slider

The measurement value readings are usually taken with the workpiece clamped (or in close contact). However, depending on the measuring location, the orientation during measurement and so on, it may be difficult to get a reading in this position. In this case, tighten the slider clamp screw, move the caliper carefully away from the workpiece, and read the display.

Using the thumb roller

The thumb roller is a fine feeding device, and not a constant-force device. Measuring force tends to be large when measuring with the thumb roller. Carefully apply an appropriate and even measuring force when using the thumb roller.

Using the switch (about Icons)



6. Confirmation before Measurement

Confirming Slider Movement

- Confirm that there is no irregular slider movement and that the slider moves smoothly throughout the measurement range.
- Confirm that there is no play of the slider in the vertical direction against the sliding surface.

Confirming Clearance (Wear) between Measuring surfaces

- When the outside measuring jaws are closed and held to the light, confirm that there is no slit observed between the jaws against the light, or that a faint light is uniformly visible. As well, confirm that the jaw tips are not deformed.
- When the inside measuring jaws are closed and held to the light, observing the jaws obliquely, confirm that a light is uniformly visible, and that the tips are not deformed.

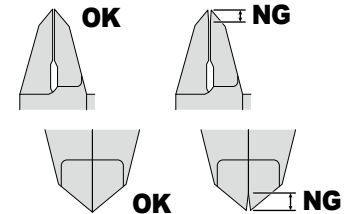

7. 電池のセットと ORIGIN (原点) 設定

注記

取り扱いを誤った場合、「物的損害の発生が想定される」内容を示します。

- 電池は必ず SR44 (酸化銀ボタン電池) をご使用ください。付属の電池は、機能や性能を確認するためのものです。所定の寿命を満足しない場合があります。
- 電池をセットするときは、電池端子が破損しないようにご注意ください。

! 消耗した電池の廃棄にあたっては、条例、規制などに従ってください。

7.1 電池のセット

- 1 付属の電池蓋キーを電池蓋の溝に差し込み、溝が垂直になるまで押し込みながら反時計回りに回して電池蓋を緩める
- 2 緩んだ電池蓋を取り除く
- 3 電池 (SR44) のプラス側を上にしてセットする
- 4 電池蓋のパッキンがよじれないで正しく取り付けられていることを確認する
- 5 電池蓋の溝が垂直 (下図) になるようにして、電池蓋を乗せる
- 6 電池蓋キーを電池蓋の溝に差し込み、押し込みながら溝が水平になるまで時計回りに回して電池蓋を取り付ける
» 「----」の表示が点滅する。
引き続き ORIGIN (原点) 設定を行ってください。

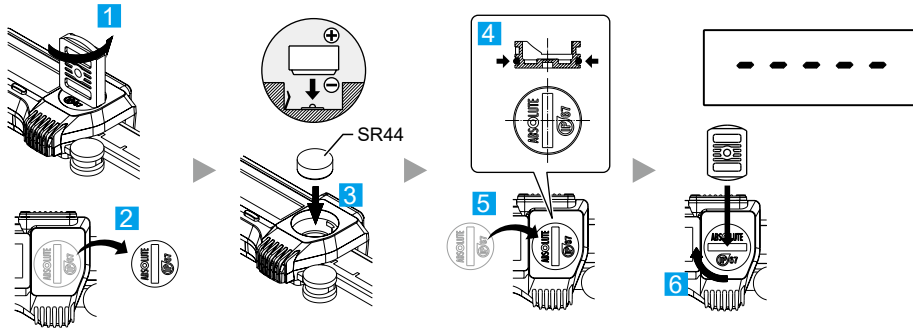

Tips

電池をセットした後は、必ず ORIGIN (原点) 設定を行ってください。

7.2 ORIGIN (原点) 設定

- 1 外側用測定面を閉じた状態にする
- 2 [ORIGIN] スイッチを長く押す
» 「0.00」と表示され、ORIGIN (原点) が設定される。

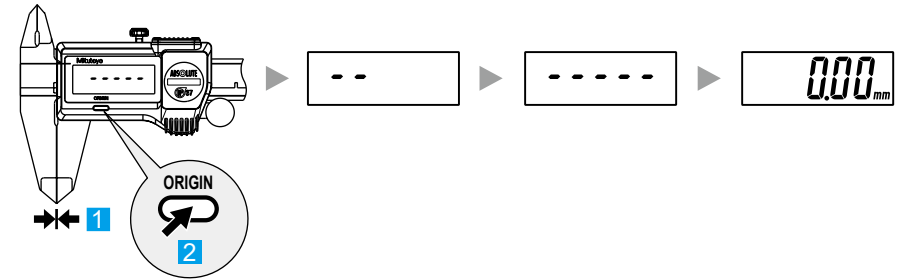

Tips

[ORIGIN] スイッチを押して ORIGIN (原点) が設定されるまでの間、スライダを移動しないでください。正常にカウントしない場合があります。

■ オートオフ、オートオン機能

約 20 分間スライダを動かさないと表示が消えます (原点位置は常に記憶されています)。再度表示させたいときは、スライダを動かしてください。

9. Measurement Method

WARNING Indicates a potentially hazardous situation which, if not avoided, could result in death or serious injury.



Do not measure the workpiece with the caliper if it is rotating, etc. Measuring surfaces will be worn out.

Outside measurement

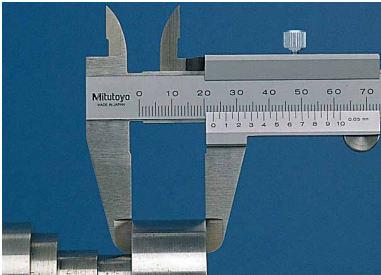

Picture: Vernier caliper

- Do not apply excessive force to the workpiece. Excessive measuring force will cause measurement error because of the positional deviations of the jaws.
- Do not clamp the workpiece diagonally. Measurement error will ensue if tilted.
- Clamp the workpiece as close to the sliding surface as possible. Measurement error is more likely to increase if clamped near the outside measuring jaw tips.

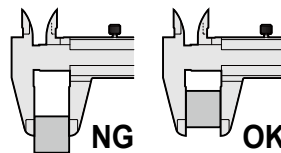
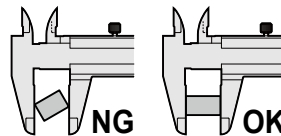
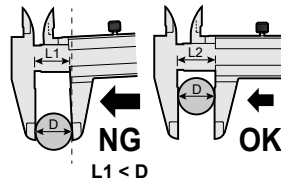

- Insert the workpiece into the outside measuring jaws and bring jaws into close contact with the workpiece, using appropriate and uniform measuring force.
- Read the display while keeping the outside measuring surfaces in close contact.

Inside measurement

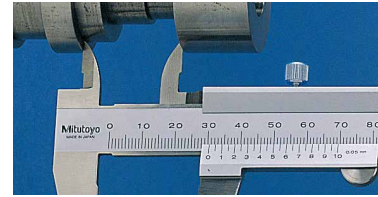

Picture: Vernier caliper

- Insert the inside measuring jaws as deeply as possible into the workpiece.

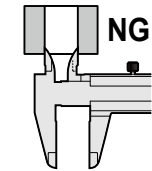
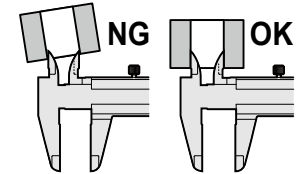

- For inner diameter measurement, bring the inside measuring surfaces into close contact, and read the display when it is maximum: a direct line between the measuring surfaces passes through the center of the cross-section.
- For groove width measurement, bring the inside measuring surfaces into close contact, and read the display when it is minimum: a direct line between the faces is perpendicular to the groove inner wall.

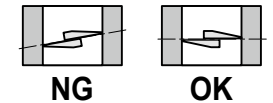
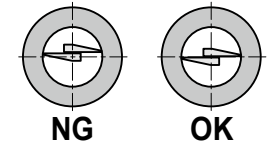

- Insert the inside measuring jaws into the workpiece, and bring jaws into close contact with the workpiece interior using appropriate and uniform measuring force.
- Read the display while keeping the inside measuring surfaces in close contact.

■ Step measurement

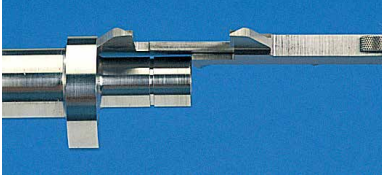

Picture: Vernier caliper

- Do not use a depth bar for step measurement, as the small contact area with the workpiece makes it difficult to retain a stable orientation.
- For a stepped workpiece, bring the entire step measuring surfaces (①, ②) into close contact with the workpiece.

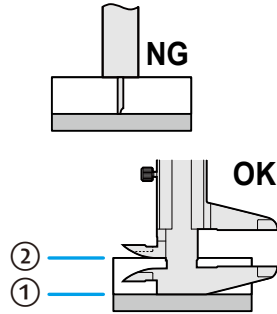

- 1 Bring the step measuring surface (①, beam side) into close contact with the workpiece.
- 2 Move the slider until the step measuring surface (②, slider side) strikes the workpiece (stepped surface).
- 3 Read the display while keeping the step measuring surfaces in close contact.

■ Depth measurement



Picture: Vernier caliper

The depth measuring surface of the caliper is narrow and unstable. Bring it into contact perpendicular with the workpiece.

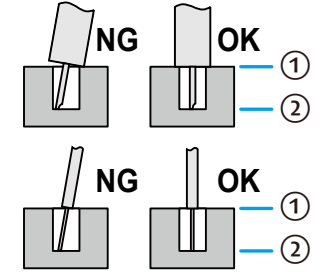

- 1 Bring the depth measuring surface (beam side) into close contact with the workpiece.
- 2 Move the slider until the depth measuring surface (depth bar side) makes contact.
- 3 Read the display while keeping the depth measuring surfaces in close contact.

10. Errors and Countermeasures

Minimum digit “E” display

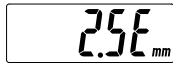

This digit appears if the surface of the scale is dirty to an immeasurable degree. Clean the surface of the scale cover.

If “E” still appears even after the surface of the scale cover is cleaned, reinstall the battery. Nevertheless, if it does not disappear, remove the battery, and then contact your distributor or sales office.

“B”, “” and “Err--b” display

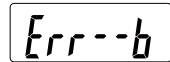
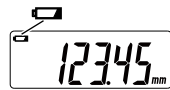
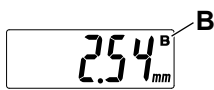

“B” indicates the voltage drop of the battery. Replace the battery immediately. (For instructions on replacing the battery, see “8.”).

If all five digits have the same number, or if “H” blinks



Remove the battery temporarily, and then reinstall it.

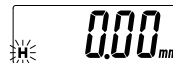

Other errors

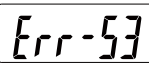
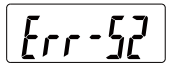
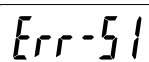
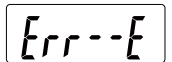
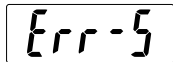

If the error shown in the figure occurs, set the origin again.

11. Precautions after Use

- If there is dirt on the measuring surface, reference surfaces, sliding surface, etc., wipe it away with a dry cloth or a cloth slightly moistened with alcohol.
- For long-term disuse, wipe away any dirt carefully and apply a light coating of rust preventive oil before storage.
- Do not store in locations with high temperatures, low temperatures, high humidity, or exposure to direct sunlight.

12. Specifications

Resolution	0.01 mm
Maximum permissible error E_{MPE} (outside measurement) S_{MPE} (inside measurement)	 See “MPE (E_{MPE} , S_{MPE})”.
Protection level	IP67* *IP67 protection level (See IEC 60529 for details.) - Protection against foreign matter (level 6) : Foreign matter does not enter - Protection against water (level 7) : The module is protected against water damage to a depth of one meter for 30 minutes.
Maximum response speed	No limit (no miscount caused by speed)
Power supply	SR44 (silver oxide battery) 1 pc
Battery life	A continuous use of about 18,000 hours, A typical use of about 5 years The battery life depends on how many times and in which ways it is used. Remember that the above values are a guideline. The value of the typical use has been calculated assuming that the product is used for about five hours per day.
Operating temperature	0 °C to 40 °C
Storage temperature	-10 °C to 60 °C

The display of this product may flicker or turn off due to electromagnetic interference by electrostatic charge, but it returns to the normal state after the electromagnetic interference is cleared.

MPE (E_{MPE} , S_{MPE})

500 Sereis

0.01 mm

*L (mm)	E_{MPE} (mm)	S_{MPE} (mm)
$0 \leq L \leq 200$	± 0.02	± 0.04
$200 < L \leq 300$	± 0.03	± 0.05

0.01 mm / 0.0005 in

*L (mm)	E_{MPE} (mm)	S_{MPE} (mm)	*L (inch)	E_{MPE} (inch)	S_{MPE} (inch)
$0 \leq L \leq 200$	± 0.02	± 0.04	$0 \leq L \leq 8$	± 0.0010	± 0.0020
$200 < L \leq 300$	± 0.03	± 0.05	$8 < L \leq 12$	± 0.0015	± 0.0025

*L

jp 測定長さ	sv Mätlängd	zh-CN 测量长度
en Measuring length	pt Comprimento de medição	zh-TW 量測長度
de Messlänge	cs Měřená délka	th ความยาวในการวัดสูงสุด
es Longitud de medición	pl Długość pomiaru	vi Độ dài đo lường
fr Longueur de mesure	ru Длина измерения	ms Panjang pengukuran
nl Meetlengte	tr Ölçme uzunluğu	id Panjang pengukuran
it Lunghezza di massima	ko 대 측정 길이	