

Bright/Dark field, Wide-FOV Video Microscope Unit "WIDE VMU Series"

No. 99MBA118B
SERIES No. 378

Precautions for Use

- Important**
- **Prevention of impact:** When assembling or operating the video microscope unit, handle it carefully so that no part is subjected to any impact or excessive force.
 - **Careful carrying and conveying:** When carrying the video microscope unit, carefully hold the main unit.
 - **Where to install:** Install the video microscope unit on a level and stable table at a site where the microscope unit will not be subjected to direct sunlight, dirt, dust, high temperature, high humidity, or vibration.
 - **Prohibition of disassembling:** Disassembling any portion may damage the performance or result in injury, or failure. Accordingly, do not ever disassemble any portion other than the portions specified to be disassembled.
 - **WIDE VMU** consists of precise components. Accordingly, if you should disassemble this product, the performance cannot be guaranteed even within the warranty period. Furthermore, if you should disassemble this product and this product fails, it will be subject to a repair charge.
 - When you would like to incorporate **WIDE VMU** in a high-speed or high-acceleration equipment, be sure to contact Mitutoyo in advance.

- Warranty** In the event that the Mitutoyo product, except software product, should prove defective in workmanship or material, within one year from the date of original purchase for use, it will be repaired or replaced, at out option, free of charge upon its prepaid return to us.
If the product fails or is damaged for any of the following reasons, it will be subject to a repair charge, even if it is still under warranty.
- Failure or damage owing to inappropriate handling or unauthorized modification.
 - Failure or damage owing to transport, dropping, or relocation of the product after purchase.
 - Failure or damage owing to fire, salt, gas, abnormal voltage, or natural disaster.

Export Control Compliance

This product falls into the Catch-All-Controlled Goods or Program under the Category 16 of the Separate Table 1 of the Export Trade Control Order or the Category 16 of the Separate Table of the Foreign Exchange Control Order, based on the Foreign Exchange and Foreign Trade Law of Japan.
Further, this User's Manual also falls into the Catch-All-Controlled Technology for use of the Catch-All-Controlled Goods or Program, under the Category 16 of the Separate Table of the Foreign Exchange Control Order.
If you intend re-exporting or re-providing the product or technology to any party other than yourself, please consult with Mitutoyo prior to such re-exporting or re-providing.

Component Names and Dimensions

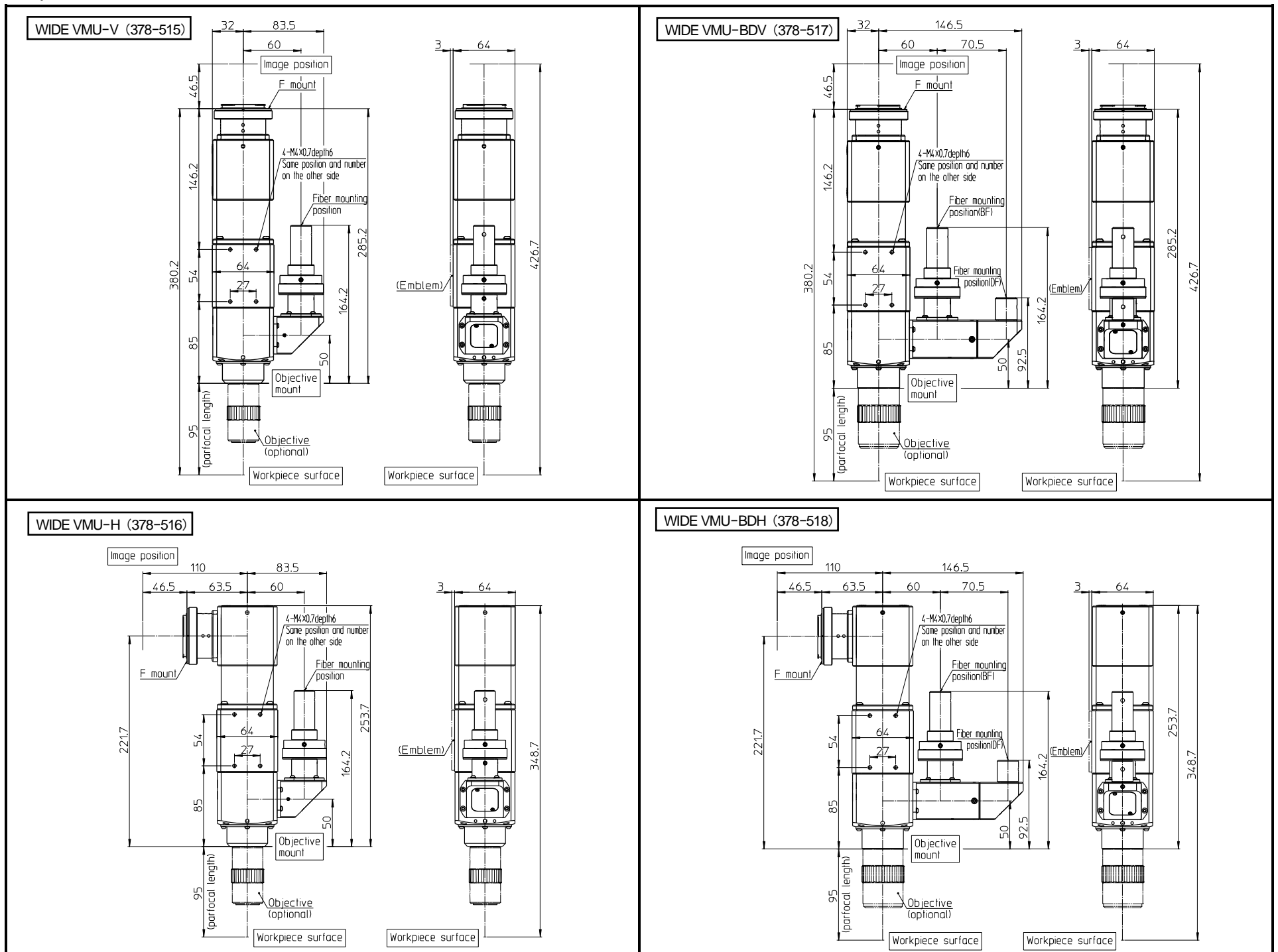

<Standard accessories (One piece each)>

Model name	WIDE VMU-V	WIDE VMU-H	WIDE VMU-BDV	WIDE VMU-BDH
Code No.	378-515	378-516	378-517	378-518
C mount adapter	○	○	○	○
Hexagon socket screw key (Nominal: 3)	○	○	○	○
Hexagon socket screw key (Nominal: 2.5)	○	○	○	○
Hexagon socket screw key (Nominal: 2)	○	○	○	○
Hexagon socket screw key (Nominal: 1.5)	○	○	○	○
User's Manual	○	○	○	○
Certificate	○	○	○	○
Packaging box	○	○	○	○

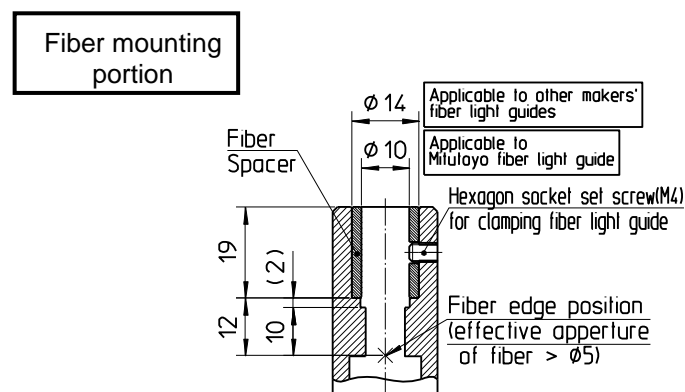

Specifications

Model name	WIDE VMU-V	WIDE VMU-H	WIDE VMU-BDV	WIDE VMU-BDH
Code No.	378-515	378-516	378-517	378-518
Camera mounting direction	Vertical	Horizontal	Vertical	Horizontal
Observation image	Bright field/Erect image	Bright field/Inverted image	Bright/Dark field/Erect image	Bright/Dark field/Inverted image
Camera mount	F mount, C mount (The parfocal adjustment and the centering adjustment are performed independently.)			
Applicable sensor size	APS-C (corresponding to 2 inches)			
FOV in camera port	$\phi 30$ ※1			
Tube lens	Magnification: 1× Visible light			
Reflected illumination optical system	Telecentric illumination			
Illumination tube	Bright field illumination tube (rotatable) 1 port fiber illumination		Bright/Dark field illumination tube (rotatable) 2 port fiber illumination	
Applicable objective (Optional)	M Plan Apo series G Plan Apo series		BD Plan Apo series	
Mass of main unit	1,800 g	1,950 g	2,000 g	2,150 g

※1 When a low-magnification objective is used, the brightness in the peripheral portion of the FOV is lower than the brightness in the central portion of the FOV.

System Configuration

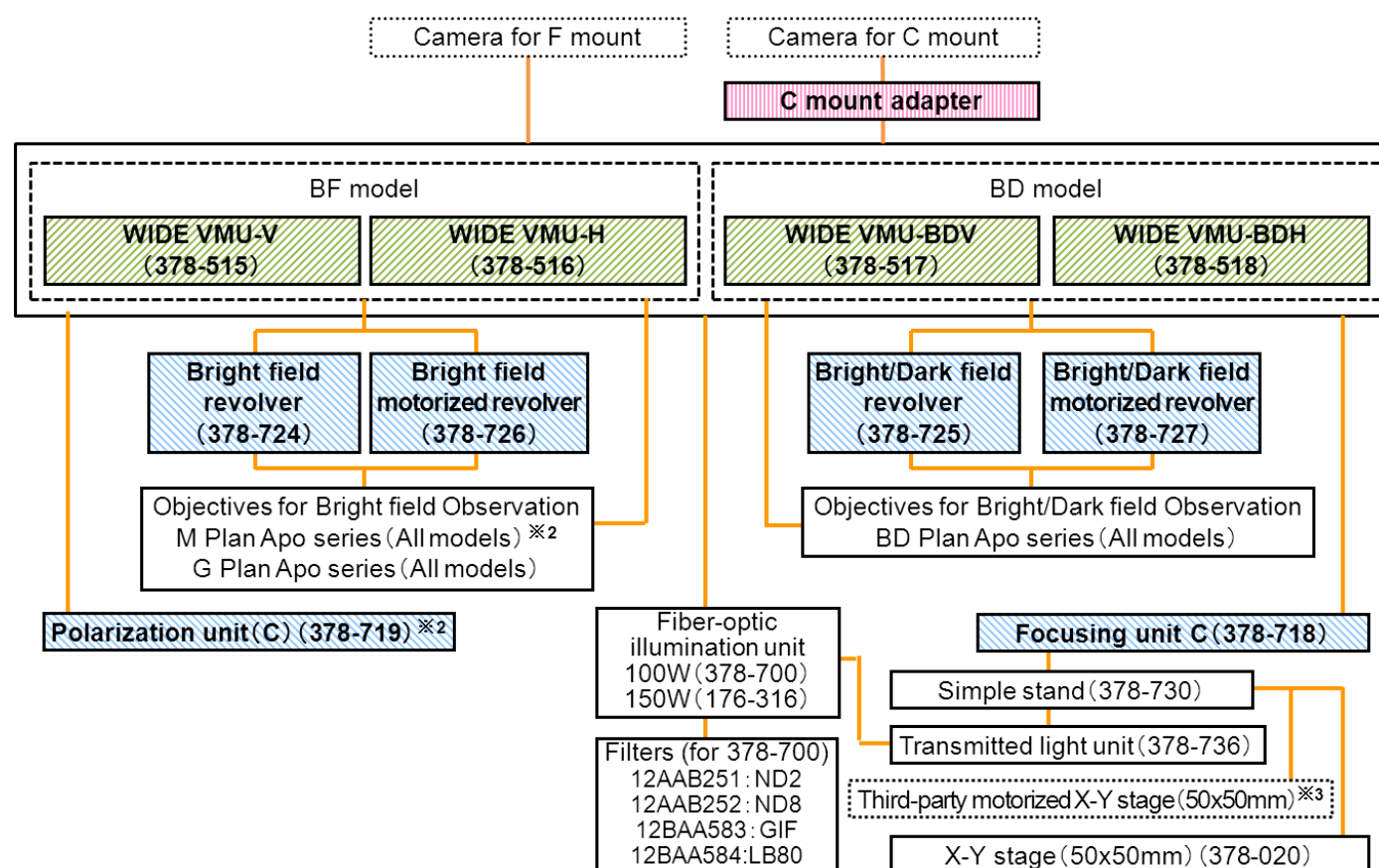

※2 For the polarization unit (C), the objectives with a magnification of 2x or larger are applicable.

※3 An adapter may be required when mounting any of these stages. Contact your dealer or the nearest Mitutoyo sales office.

Accessories

品名 (Code No.)	WIDE VMU-V	WIDE VMU-H	WIDE VMU-BDV	WIDE VMU-BDH
	378-515	378-516	378-517	378-518
Fiber-optic illumination unit 100W (378-700)	○	○	○	○
ND2 filter for 378-700 (12AAB251)	○	○	○	○
ND8 filter for 378-700 (12AAB252)	○	○	○	○
GIF filter for 378-700 (12BAA583)	○	○	○	○
LB80 filter for 378-700 (12BAA584)	○	○	○	○
Fiber-optic illumination unit 150W (176-316)	○	○	○	○
Focusing unit C (378-718)	○	○	○	○
Simple stand (378-730)	○	○	○	○
Transmitted light unit (378-736)	○	○	○	○
X-Y stage (378-020)	○	○	○	○
Bright field revolver (378-724)	○	○		
Bright/Dark field revolver (378-725)			○	○
Bright field motorized revolver (378-726)	○	○		
Bright/Dark field motorized revolver (378-727)			○	○
Polarization unit (C) (378-719)	○	○	○	○
Objective M Plan Apo series	○	○		
Objective G Plan Apo series	○	○		
Objective BD Plan Apo series			○	○

WIDE VMU-V·H·BDV·BDH

1.2(1)

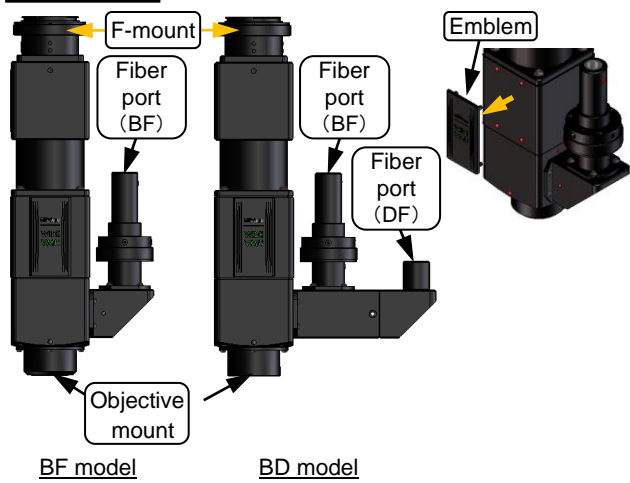

BF model

BD model

1.2(3)

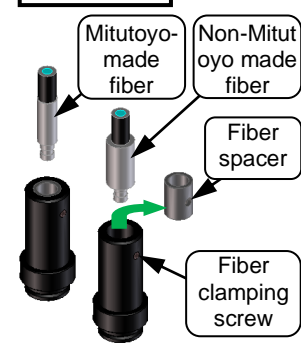

1.2(4)

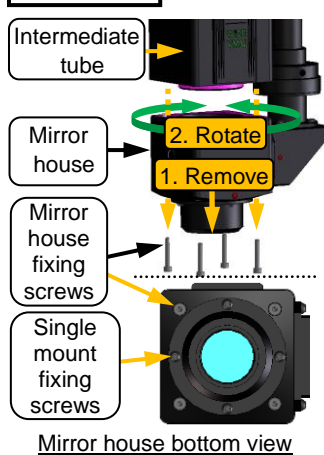

Mirror house bottom view

1.2(5)

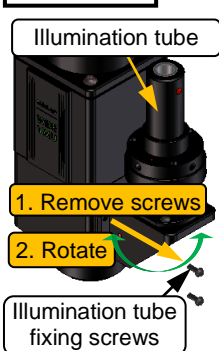

1.2(6)~(8)

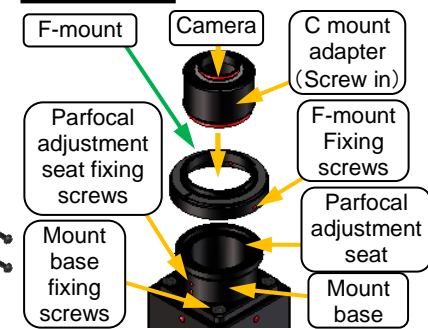

2.1

1. Remove the single mount

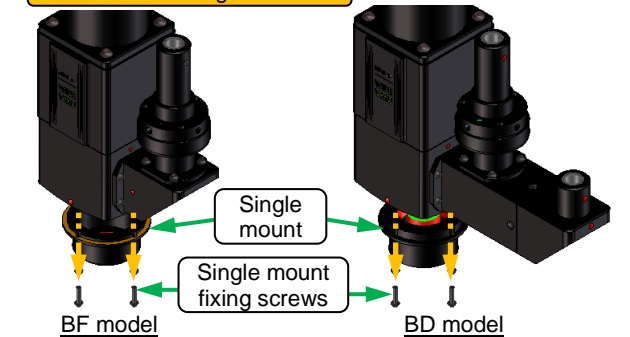

BF model

BD model

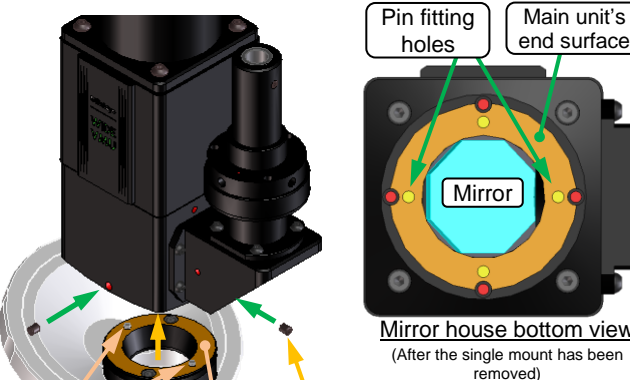

Mirror house bottom view
(After the single mount has been removed)

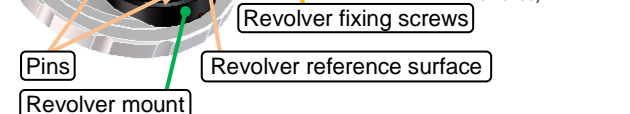

2. Press the revolver reference surface onto the main unit's end surface.

3. Fix the revolver mount by 2 pieces of revolver fixing screws (90°).

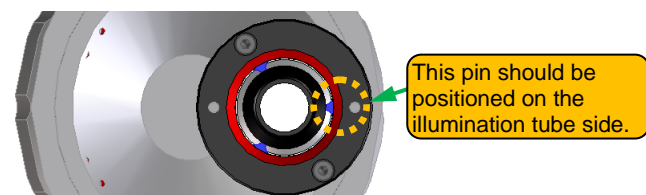

Orientation of revolver
(in case of [Code No. 378-725])

1 Setup

1.1 Unpacking and Checking

Before shipment from the factory, **WIDE VMU** is thoroughly inspected so that its mechanically and optically good performances are fully guaranteed. Unpack the **WIDE VMU**, and confirm that all accessories and components exist and that the **WIDE VMU** has not been damaged during shipment. If you should have any questions, contact your dealer or the nearest Mitutoyo Sales Office.

1.2 Assembling and Adjustment

(1) **Assembling:** Attach the **WIDE VMU** to your equipment, and then attach the objective, the camera, etc. to the **WIDE VMU**. To attach the **WIDE VMU** to your equipment, use 4 pieces of screws (M4x0.7, Depth: 6). When attaching the **WIDE VMU**, you can also use the attaching surface on the opposite side (namely, the emblem side). In this case, remove the emblem in advance. (The removed emblem can be mounted on the opposite side.)

(2) **Attaching the objective:** Remove the cap arranged on the objective seat, and then screw the objective into the objective seat.

(3) Attaching the fiber light guide

- Insert the fiber light guide into the fiber port, and then clamp the fiber light guide by tightening the supplied fiber clamping screw (hexagon socket set screw (M4)). When using Non-Mitutoyo-made fiber light guide, remove the fiber spacer.

IMPORTANT When a fiber that does not meet the specifications described in "Fiber mounting portion" in Section "Component Names and Dimensions" is used, good performances cannot be guaranteed. If you would like to use such fibers, contact Mitutoyo Corporation.

NOTE

- For how to use the fiber light source, refer to User's Manual of the fiber light source.
- When using the fiber-optic illumination unit 150W (176-316) for DF illumination, flare may occur for low-diffusing workpiece so that the contrast may be lowered partially. In such cases, lower the light intensity.

TIP

For BD models, turn on/off the light sources to switch BF and DF observations.

(4) Rotating the mirror house

- Loosen the mirror house fixing screws (hexagon socket head cap screws (M3, 4 pieces)) to remove the mirror house.
- Rotate the mirror house to the desired rotational position, and then attach the mirror house again. (The mirror house can be rotated by a pitch of 90°.)

NOTE

- Be sure to tighten the screws firmly.
- When removing and attaching the mirror house, pay attention not to touch the internal mirror.

(5) Rotating the illumination tube

- Remove the illumination tube fixing screws (hexagon socket button head screws (M3, 4 pieces)).
- Rotate the illumination tube to the desired rotational position, and then attach the illumination tube again. (The illumination tube can be rotated by a pitch of 90°.)

NOTE

- Be sure to tighten the screws firmly.
- When rotating the illumination tube, pay attention not to touch the internal mirror or lens.

(6) Attaching the camera

- In case of attaching the camera for F-mount, remove the F-mount by loosening the F-mount fixing screws (hexagon socket set screws (M3, 3 pieces)).
- Screw the camera into the F-mount, then attach the F-mount along with the camera to the **WIDE VMU** again, and then tighten the F-mount fixing screws.
- In case of attaching the camera for C-mount, attach the supplied C mount adapter to the F mount.

NOTE

- Be sure to tighten the screws firmly.
- When removing or loosening the screws for adjustment, support the camera with your hand to prevent the camera from dropping.
- When incorporating **WIDE VMU** into high-speed and high-acceleration equipment and the mass of camera is heavy, the camera should be supported not only by the camera mount (F-mount adapter or C-mount adapter), but also by your equipment.

(7) Adjusting the camera mounting position

- To adjust the focus of the camera, loosen 4 pieces of parfocal adjustment seat fixing screws (hexagon socket set screws (M3)), and then rotate the parfocal adjustment seat to adjust the focus.

(8) Adjusting the camera observation center point

- To adjust the observation center, loosen 4 pieces of mount base fixing screws (hexagon socket head cap screws (M4)), and then swing the mount base to adjust the observation center.

(9) Adjustment procedure of camera mounting position/camera observation center point

- When plural objectives are used by being arranged on the revolver, etc., it is necessary to adjust the center position of observation and the focus. The following adjustment procedure should be used when plural objectives are used.

[a] Select the objective with the maximum magnification, then move the equipment in the X-Y plane to align the target position of the workpiece with the center of the monitor, and then move the equipment along the Z axis so that the image is focused. Then select the objective with the minimum magnification, and then check the state of the centering and focusing.

[b] If the centering is not good enough, loosen the mount base fixing screws, and then move the mount base in the horizontal plane (in case of V type).

[c] If the focusing is not good enough, loosen the F-mount fixing screws and the parfocal adjustment seat fixing screws, and then rotate the parfocal adjustment seat to translate the camera forward and backward.

[d] Select the objective with the maximum magnification again, then move the equipment in the X-Y plane to align the target position of the workpiece with the center of the monitor, and then move the equipment along the Z axis so that the image is focused. Then select the objective with the minimum magnification, and then check the state of the centering and focusing. If the centering is not good enough, go back to the step [b]; and if the focusing is not good enough, go back to the step [c].

- To adjust the tilt of the monitor observation image, loosen the F-mount fixing screws, and then rotate the F-mount along with the camera.

2 How to Attach Accessories

2.1 How to Attach Bright field revolver [Code No. 378-724],

Bright/Dark field revolver [Code No. 378-725],

Bright field motorized revolver [Code No. 378-726],

and Bright/Dark field motorized revolver [Code No. 378-727]

- Loosen 4 pieces of single mount fixing screws (hexagon socket head cap screws (M3)) to remove the single mount.
- Main unit's end surface and the pin fitting holes appear at the bottom of the mirror house.
- Insert the desired revolver into the mirror house by fitting the outer circumference of the revolver into the lower inside diameter portion of the mirror house. Then press the revolver reference surface onto the main unit's end surface in the state that the pins of the revolver mount fit in the pin fitting holes of the mirror house.
- Fix the revolver mount by 2 pieces of revolver fixing screws (hexagon socket set screws (M4)) supplied along with the revolver. (Use two of the three threaded holes of the mirror house.)

IMPORTANT ● The revolver should be attached in the orientation shown in the left figure.

NOTE

- When the single mount is removed, the mirror is exposed. Pay enough attention.

TIP

- In **WIDE VMU**, the position of the objective mount is not changed between when attaching the single mount and when attaching the revolvers, so that the compatibility can be obtained.
- Refer to "2.2 How to Attach Focusing Unit C" for information on using a focusing unit.

2.2

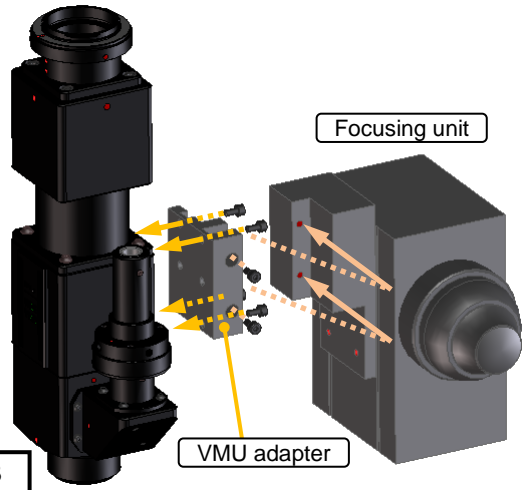

2.2 How to Attach Focusing Unit C [Code No. 378-718]

- Remove the VMU adapter from the focusing unit by loosening the hexagon socket head cap screws (M4, 2 pieces)
- Fix the VMU adapter to the **WIDE VMU** by tightening the hexagon socket head cap screws (M4, 4 pieces)
- Attach the VMU adapter to the focusing unit again.

NOTE

- When using both the focusing unit C and one of the revolvers, the mirror house and the illumination tube should be used at the positions at Mitutoyo shipment.

TIP

- When using both the focusing unit C and the simple stand, the optical axis of the **WIDE VMU** is aligned with the center of the simple stand.

2.3

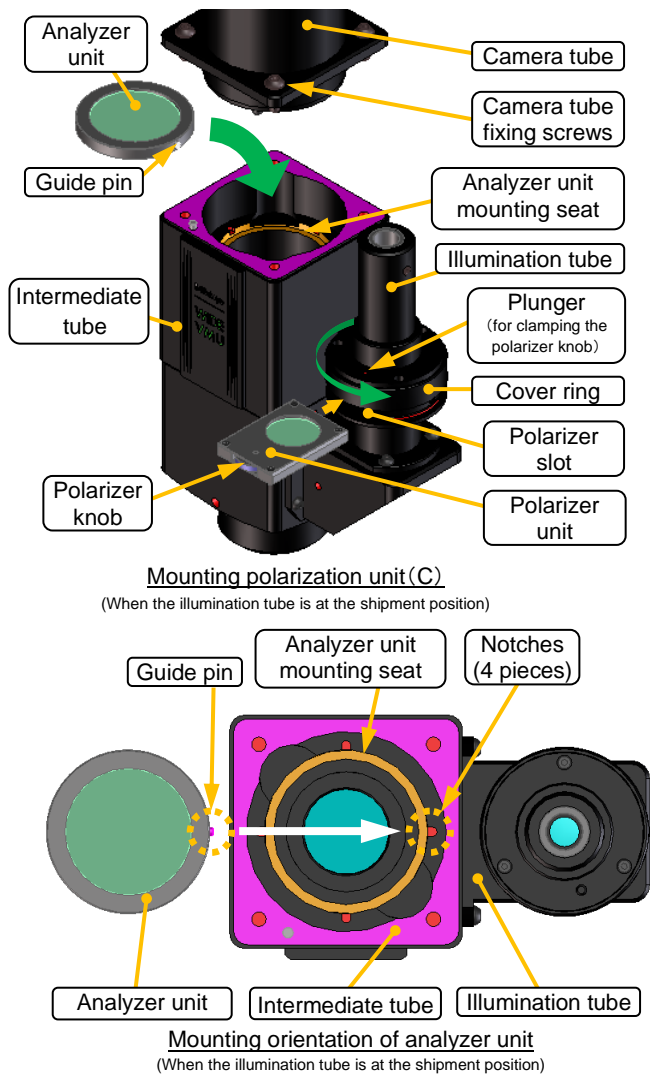

2.3 How to Attach Polarization Unit (C) [No.378-719]

(1) How to attach the analyzer

- Remove the camera tube from WIDE VMU by loosening 4 pieces of hexagon socket head cap screws (M4), then house the analyzer unit on the analyzer unit mounting seat of the intermediate tube, and then attach the camera tube again.

IMPORTANT

- The guide pins of the analyzer unit should be fit in the notches of the analyzer unit mounting seat.
- In case that the illumination tube is at the shipment position, the orientation of the guide pin should be on the illumination tube side (or on the opposite side (180°)).
- In case that the mounting position of the illumination tube has been changed from the shipment position, the orientation of the analyzer unit should be changed. When the orientation of the illumination tube has been changed for 90°, the orientation of the guide pin should be also changed for 90°.

TIP

- The mounting position of the mirror house is independent from the orientation of the analyzer unit.

(2) How to attach the polarizer

- Loosen the cover ring of the illumination tube manually, and then rotate the cover ring so that the cover ring moves to the end surface on the fiber port side. Thus the polarizer slot appears.
- Insert the polarizer unit into the polarizer slot until the polarizer unit is stopped, then rotate the cover ring in the reverse direction to clamp the polarizer unit.

TIP

- As shown in the figure below, the polarizer unit has the front and rear sides. The front surface of the polarizer unit should be positioned on the fiber port side.
- The state of polarization observation changes by rotating the polarizer knob.
- The polarizer knob can be clamped to prevent the polarizer knob from shifting due to vibration, etc. To clamp the polarizer knob, screw in the plunger of the illumination tube by using the hexagon socket screw key (nominal: 0.89) supplied along with the polarization unit (C).
- Even when the polarizer knob is clamped, the polarizer knob can be operated. However, when you would like to remove the polarizer unit, release the clamp of the polarizer knob.

3 Maintenance and Check

To maximize the performance of **WIDE VMU** and ensure safe and good use of **WIDE VMU** for a long period, daily care and periodic check should be done.

3.1 Daily Care

Especially, dust and dirt are harmful to the **WIDE VMU**. Perform daily care and store the **WIDE VMU** appropriately.

(1) **Cleaning of optical components**: Carefully clean the optical components such as lenses and filters, according to the following method.

- **Dust**: Clean the optical components with a clean lens brush, or a soft brush; or wipe them with gauze.
- **Fingerprints and oil**: Wipe the optical components gently with a lens cleaning paper or gauze dampened with a small amount of pure alcohol (ethanol or methanol).

(2) **Cleaning of metallic portions**: Wipe them lightly with silicon cloth.

NOTE If you use any cleaning agent, solvent, or polish material, the surface may be discolored or the paint may be peeled off. Accordingly, do not use such cleaning agents, solvents, or polish materials.

(3) **Storage**: When you will not use the **WIDE VMU** for a long time, store it in a place where the humidity is low so that mold will not grow. Especially, the optical components such as objectives should be housed in the corresponding cases and stored.

3.2 Periodic Check

To maintain high performances of VMU, Mitutoyo recommends you to receive the periodic check by a Mitutoyo service engineer. Contact your dealer or the nearest Mitutoyo Sales Office.

4 Troubleshooting

When the **WIDE VMU** malfunctions, diagnose the problem and remedy the situation with the aid of the table below. If you cannot remedy the problem, contact your dealer or the nearest Mitutoyo Sales Office.

Phenomenon	Point to check	Remedy
Obstacles or dark areas appear in the field of view.	1) Is the lens or the workpiece contaminated?	1) Clean the contaminated portions.
Poor contrast, resolution, or image quality	1) Is the lens or the workpiece contaminated? 2) Is the brightness of illumination enough? 3) Are you observing the workpiece through a medium other than air, such as a cover glass?	1) Clean the contaminated portions. 2) Increase the brightness of illumination. 3) Use the exclusive objective. Remove the cover glass or other intervening medium.
One side of the image is obscure, or the image sways.	1) Is the workpiece tilted? 2) Has the objective been screwed in firmly?	1) Correct the tilt of the workpiece. 2) Screw the objective in firmly.