

High-Accuracy Digimatic Micrometer MDH-MB



Safety Precautions

To ensure operator safety, use this product according to the directions, functions and specifications given in this User's Manual.

Use under other conditions may compromise safety.

WARNING Shows risks that could result in death or serious injury.

- Always keep batteries out of reach of children, and if swallowed, consult a physician immediately.
- Batteries should never be short-circuited, disassembled, deformed or come in contact with extreme heat or flames.
- If battery alkaline liquid comes in contact with the eyes, flush eyes immediately with clean water and consult a physician. If battery alkaline liquid comes in contact with the skin, flush the exposed area thoroughly with clean water.

CAUTION Shows risks that could result in minor or moderate injury.

- Never attempt to charge the primary battery or reverse the positive-negative terminals when mounting. Improper battery handling or mounting may cause the battery to explode, cause battery leakage, serious bodily injury, or malfunction.
- Always handle the sharp measuring faces of this product with care to avoid injury.

NOTICE Shows risks that could result in property damage.

- Do not disassemble or modify.
- Do not use or store the product in a place with sudden temperature changes. Also, before using the product, allow it to acclimate to room temperature.
- Do not store the product in a place with high humidity or a lot of dust. Do not use the product in an environment where it may contact water or oil.
- Do not apply excessive force or subject the product to sudden impacts such as dropping.
- Remove dust, cutting chips, etc. before and after use.
- When cleaning, wipe this product with a soft cloth moistened with diluted neutral detergent. Do not use an organic solvent such as thinner, which may cause the product to deform or malfunction.
- Do not press the display unit.
- The spindle is structured so that it cannot be pulled out. Do not forcibly retract it in excess of the measuring range.
- Dirt on the spindle may lead to malfunction. If the spindle becomes dirty, wipe it clean with a cloth containing a small amount of alcohol and apply a small amount of micrometer oil (Part No. 207000).
- If Micrometer Oil is not available and you must use a commercially available product, we recommend using an anti-rust agent with low viscosity almost equivalent to ISO VG10.
- Do not write numbers, etc. with an electric pen.
- If the product is to be out of use for three months or more, remove the battery before storage. Liquid leakage from the battery may damage the product.

Key operation icon

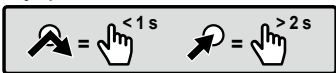

Contents

1. Names of Components	Page 1
2. Installing the Battery.....	Page 1
3. Precautions for Use.....	Page 2
4. Turning the Power On or Off	Page 2
5. PRESET Value (Reference Point) Setting.....	Page 2
6. Measurement Method	Page 2
7. Key Functions	Page 3
8. Setting the Parameters	Page 3
9. Installing the Heat-Resistant Cover.....	Page 4
10. Errors and Troubleshooting.....	Page 4
11. Specifications	Page 4
12. Output Function.....	Page 4
13. Measurement Error Due to Temperature Fluctuations	Page 5
14. Optional Accessories.....	Page 5
15. Off-Site Repairs (Subject to Charge).....	Page 5

1. Names of Components

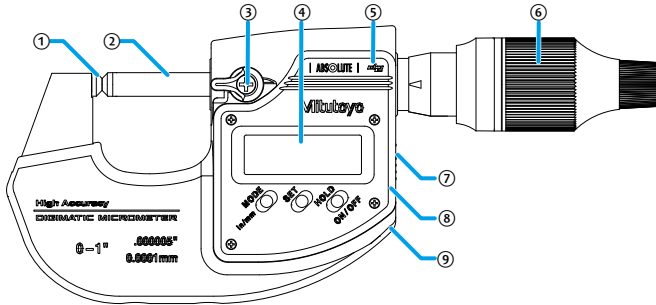

- | | |
|---|---------------------------------------|
| ① Anvil | ⑥ Ratchet thimble |
| ② Spindle | ⑦ Cover |
| ③ Swivel clamp (locks the spindle to prevent motion) | ⑧ Data output connector |
| ④ Display unit (LCD) | ⑨ Battery compartment cover (at rear) |
| ⑤ Marking for products compatible with 8-digit output | |

■ Display Unit (LCD)

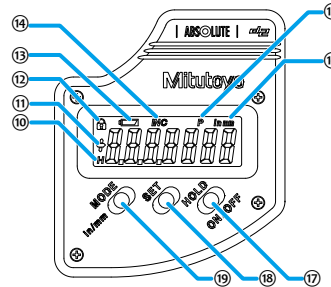

- | | |
|-------------------------|-----------------------------------|
| Ⓜ Hold display | Ⓜ Preset display |
| Ⓜ Sign display | Ⓜ Unit display |
| Ⓜ Function lock display | Ⓜ [HOLD] key, [ON/OFF] key |
| Ⓜ Low voltage display | Ⓜ [SET] key |
| Ⓜ INC display | Ⓜ [MODE] key |
| | [in/mm] key (in/mm products only) |

2. Installing the Battery

NOTICE Shows risks that could result in property damage.

Always align the battery compartment cover with the threads and install so that the gasket does not protrude. The product may display an error or malfunction if the battery compartment cover or the gasket is not mounted correctly.

Tips

- Be sure to use CR2032 (lithium battery) for the battery.
- Do not rotate the thimble until the count is displayed. Initial setting of the control unit may fail and the product may not count normally. If you mistakenly move the thimble, reinstall the battery.
- The battery supplied is for confirming the functions and performance of the product. Note that this battery may not fulfill the predetermined life.
- Malfunction or damage due to depleted batteries, etc. is not covered by the warranty.
- Follow local rules and regulations regarding battery disposal.

The battery is not installed into the product at purchase. Install the battery as follows.

- 1 Insert the wrench (standard accessory, part No.200877), a coin, or a similar object into the groove of the battery compartment cover, and turn it left (counterclockwise) to remove the cover.
- 2 Install the battery (CR2032) in the direction of the arrow with the positive side facing up.
- 3 Position the battery compartment cover and turn it right (clockwise) to attach. Moving on, set the PRESET value (reference point).
- 4 Press the [SET] key.
 - › Count display appears and counting starts.

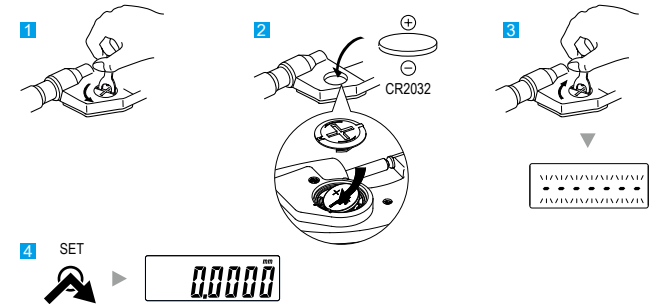

Tips

- Reinstalling the battery will erase the PRESET value (reference point). Perform reference point setting again (see "5. PRESET Value (Reference Point) Setting").
- If an abnormal display that indicates an error or counting failure, etc., is shown, try removing the battery and reinstalling.

3. Precautions for Use

■ Precautions for High-Accuracy Measurements

Exercise caution for the following points when performing high-accuracy measurements at 0.1 μm resolution with this product.

● Temperature

- If the product is used while being held in your hands, it will lengthen by about 0.5 μm after 10 minutes (see "13. Measurement Error Due to Temperature Fluctuations"), so install the micrometer stand and then measure. Alternatively, measure while using the heat-resistant cover.
- Accuracy is assured at an ambient temperature of 20 °C. When performing high-accuracy measurements at other ambient temperatures, performing comparative measurements with a gauge block or master workpiece is recommended.
- Before using the product, allow it to acclimate to room temperature.

● Cleaning the measurement surface

- Accurate measurements cannot be made if dirt is affixed to the measurement surface. The measurement results will also be affected if there is an oil film. For that reason, the measurement surface and measurement parts of the workpiece must be cleaned prior to measuring.
- For details about cleaning the measurement surface, see "3. Precautions for Use ■ Cleaning the Measurement Surface".

● Measuring force

- If the constant-pressure mechanism that is mounted on this product is used, the measuring force will be about 8 N. However, if excessive force is applied to the spindle when the constant-pressure mechanism is used, the measuring force will vary greatly, causing an error.
- Exercise caution so excessive force is not applied to the spindle when the constant-pressure mechanism is used.

Tips

The error for a 1 N change in measuring force is about 0.1 μm.

● Measuring orientation

- Use the same orientation and conditions when measuring and setting the reference point.
- Installing the micrometer on the micrometer stand horizontally is recommended.

● Approach speed toward the workpiece

- If you apply too much force when bringing the measurement surface of the spindle into contact with the workpiece, the workpiece may be deformed, and the measurement result may be affected. When measuring, bring the measurement surface of the spindle slowly into contact with the workpiece.

● Dust

- Measure in an area with minimal dust.

● Reference point setting

- Be sure to perform reference point setting before measurement. Frequently checking the reference point is recommended.

■ Cleaning the Measurement Surface

Dirt, an oil film, etc., on the measurement surface can be a source of error. Clean the measurement surface before and after measuring.

- 1 Insert the supplied wiping sheet between the measurement surface of the anvil and the measurement surface of the spindle.
- 2 Apply force to the measurement surfaces (see "3. Precautions for Use ■ Measuring Force").
- 3 Maintain this state and slowly pull the wiping sheet.
- 4 After it has been pulled, retract the spindle.

Tips

If pulled to the end, fibers of the wiping sheet, etc., may remain.

- 5 Remove the wiping sheet.

Repeat steps above two or three times.

■ Measuring Force

- Use the ratchet thimble to ensure a consistent measuring force.
- The appropriate measuring force is achieved with the following procedure: bring the measurement surfaces into light contact with the workpiece, stop momentarily, and then manually turn the ratchet thimble about three to five times.

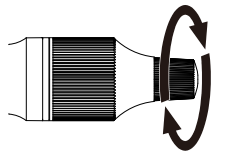

Rotate about three to five times.

■ Precautions for Measurement

- Use caution when measuring magnetized workpieces. If the product becomes magnetized, measurement results may be affected.
- When the workpiece is pinched against the measurement surfaces during a measurement, parts in contact may deform slightly. This deformation will vary according to the size and shape of the workpiece and the magnitude of the measuring force.

■ Precautions after Use

- After use, clean the entire product and check that none of the parts are damaged.
- Do not store the product in a place with high humidity or a lot of dust.
- For storage, leave a gap of 0.2 to 2 mm open for the measurement surfaces.
- If the product will not be used for three months or longer, apply micrometer oil (Part No. 207000) to the spindle to prevent rust, and store it with its battery removed.
- If Micrometer Oil is not available and you use a commercially available product, we recommend using an anti-rust agent with low viscosity almost equivalent to ISO VG10.

4. Turning the Power On or Off

■ Turning On the Power

- 1 Briefly press the [ON/OFF] key.
 - » The power will turn on.



■ Turning Off the Power

- 1 Press and hold the [ON/OFF] key.
 - » The power will turn off.



Tips

- The product will be in measurement mode when the power is turned on.
- The measurement system (ABS/INC) used when the power is turned on will be the measurement system when the power is turned off. (For details about the measurement system (ABS/INC), see "7. Key Functions ■ Switching the Measurement Mode: [SET] Key".)
- If the power does not turn on even when the [ON/OFF] key is pressed, the battery has been consumed. Replace the battery.
- If the power is turned off during setup, setup will be canceled and the settings will return to their previous values.
- The display of this product automatically turns off if this product is not used for 20 minutes or more. Briefly press the [ON/OFF] key to turn the display on again.

5. PRESET Value (Reference Point) Setting



- Always check and set the reference point before measuring with the following procedure.
- Reference point setting and measurement should be made in the same orientation and conditions with the procedure as below.

■ When the Battery is Installed

- 1 Clean both the anvil and spindle measurement surfaces to remove all debris or dust.
- 2 Install the battery (see "2. Installing the Battery").
 - » [- - - - -] will blink on the display unit.



- 3 Bring the measurement surfaces into light contact with each other, stop momentarily, and then apply the appropriate measuring force (see "3. Precautions for Use ■ Measuring Force").

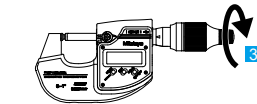

- 4 Briefly press the [SET] key.
 - » [- - - - -] will be cleared from the display unit and the value for PRESET (reference point) will be set.



■ Registering the Value for PRESET

When the measurement mode is the ABS measurement system (see "7. Key Functions ■ Switching the Measurement Mode: [SET] Key"), perform the following operation.

- 1 Briefly press the [SET] key.
 - » The previously registered number is displayed and [P] blinks.



When not changing the displayed value, proceed to step 3 to finish setting the reference point. When changing the displayed value, use the following procedure to change the preset value.

<Example> Registering 5.0000 mm for P (preset value)

- 2 Press and hold the [SET] key.
 - » The sign blinks.



Tips

- Briefly press the [MODE] key to switch between [+] and [-].

- 3 Briefly press the [SET] key.
 - » The sign will be confirmed, and the leftmost number will blink.



- 4 Briefly press the [MODE] key until [0] is displayed.



Tips

The numbers will switch in order from [0] to [1] to [2] up to [9] and then [0] each time the [MODE] key is briefly pressed.

- 5 Briefly press the [SET] key.
 - » The number in the next digit blinks.



- 6 Repeat steps 4 and 5 so that [0], [0], [5], [0], [0], [0], and [0] are displayed for the digits.

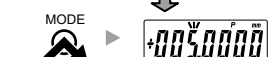

- 7 Briefly press the [SET] key until [P] blinks.

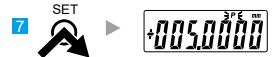

- 8 Briefly press the [SET] key.
 - » [P] is cleared, the reference point setting is complete, and the product returns to the ABS measurement system mode.

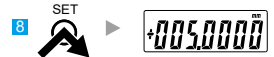

■ Reference Point Setting

When the measurement mode is the ABS measurement system (see "7. Key Functions ■ Switching the Measurement Mode: [SET] Key"), perform the following operation.

- 1 Remove any dirt or dust from both the anvil and spindle measurement surfaces and the gage.
- 2 Bring the measurement surfaces into light contact with each other, stop momentarily, and then apply the appropriate measuring force (see "3. Precautions for Use ■ Measuring Force").
- 3 Briefly press the [SET] key.
 - » The registered preset value is displayed and [P] blinks.

Tips

When changing the preset value, see steps 2 through 7 in "5. PRESET Value (Reference Point) Setting ■ Registering the Value for PRESET".

- 4 Briefly press the [SET] key.
 - » [P] is cleared.

Tips

- If the [SET] key is accidentally pressed during measurement, press and hold the [MODE] key to return to the former state.
- Do not handle gages (gauge blocks, etc.) with your bare hands. Use precision work gloves such as cotton gloves.

6. Measurement Method



- Be sure to perform reference point setting before measurement.
- Bring the measurement surface of the spindle slowly into contact with the workpiece. Moving too quickly could deform the workpiece and affect measurement results.

Gradually and lightly bring the measurement surfaces into contact with the workpiece in the same orientation and conditions as for reference point setting, apply the appropriate measuring force, and then read the display value (see "3. Precautions for Use ■ Measuring Force").

7. Key Functions

■ Switching the Measurement Mode: [SET] Key

The following two measurement systems are available.

- Absolute measurement (ABS): Distance from the set (preset) reference is measured. This is compatible with many types of workpieces since the reference value can be set.
- Comparative measurement (INC): The difference between the zero-set position and the workpiece is measured.

1 Press and hold the [SET] key.

» [INC] is displayed, and the display is set to zero (comparative measurement).

2 Press and hold the [SET] key.

» [INC] is cleared, and the length from the reference point (anvil measurement surface) is displayed (absolute measurement).

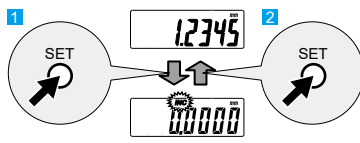

Tips

- Zero setting will be performed when the measurement system is changed from ABS to INC.
- Briefly press the [SET] key during INC measurement mode to zero-set the display.

■ Holding the Displayed Value: [HOLD] Key

1 Briefly press the [HOLD] key.

» [H] is displayed, and the display value is held.

2 Briefly press the key again to release the hold.

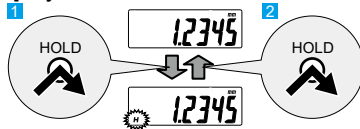

■ Switching between in and mm: [MODE]/[in/mm] Key (in/mm Products Only)

- Press the [MODE]/[in/mm] key.

» [in] and [mm] switch back and forth each time the key is pressed.

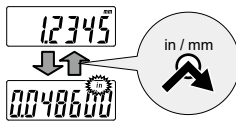

8. Setting the Parameters

Three types of parameters can be set.

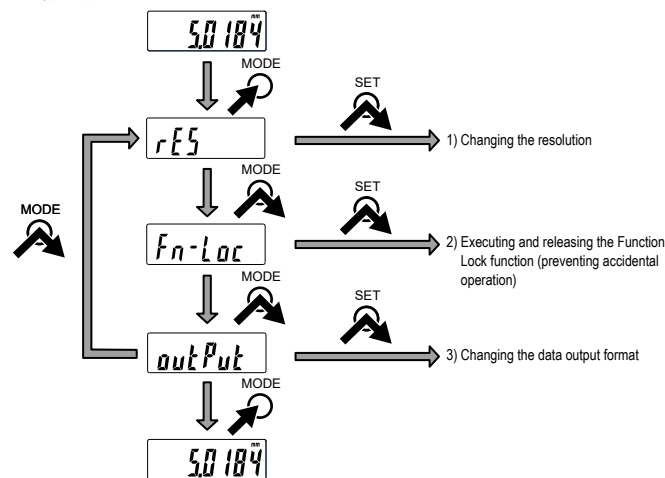

Tips

- To terminate the parameter setup before confirmation, press and hold the [MODE] key. However, unconfirmed settings will not be applied.
- Parameter settings are maintained even if the power is turned off. However, they will be erased when the battery is replaced and will need to be set again.

Key operation icon

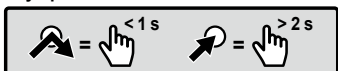

1) Changing the resolution

The resolution can be set to 0.0001 mm or 0.0005 mm (for in/mm products, 0.000005 in or 0.00002 in).

1 Switch to parameter setting mode.

Press and hold the [MODE] key.

» The product enters parameter setting mode.

2 Select the parameter to set.

1 Confirm that [rES] is blinking.

2 Briefly press the [SET] key.

» The resolution can now be changed.

3 Set the resolution.

1 Briefly press the [MODE] key to select the resolution.

» Each time the key is pressed, the setting will change in the order of 0.0001 mm, 0.0005 mm, and 0.0001 mm (for in/mm products, each time the key is pressed, the setting will change in the order of 0.000005 in, 0.00002 in, and 0.000005 in).

2 Briefly press the [SET] key.

» When the setting is confirmed, the next parameter can be set (proceeds to step 2 in "2) Executing and releasing the Function Lock function (preventing accidental operation)").

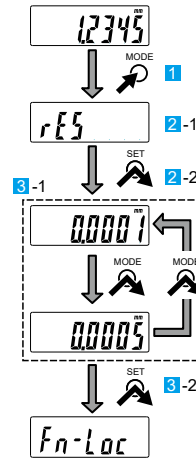

2) Executing and releasing the Function Lock function (preventing accidental operation)

This product has a Function Lock function that disables the zero-setting function and the function to change the measurement system (ABS/INC) in order to avoid accidental changes to the reference point position. When the Function Lock function is set, [Fn-Loc] will light up on the display unit, the [SET] key will be disabled, and all operations except power on/off, display value hold/release, display value output, and Function Lock function release will be disabled.

● Executing the Function Lock function

1 Switch to parameter setting mode.

Press and hold the [MODE] key.

» The product enters parameter setting mode.

2 Select the parameter to set.

1 Briefly press the [MODE] key until [Fn-Loc] is displayed.

2 Briefly press the [SET] key.

» The Function Lock function can now be changed.

3 Change the Function Lock function.

1 Briefly press the [MODE] key to select execution (on).

2 Briefly press the [SET] key.

» When the setting is confirmed, the next parameter can be set (proceeds to step 2 in "3) Changing the data output format").

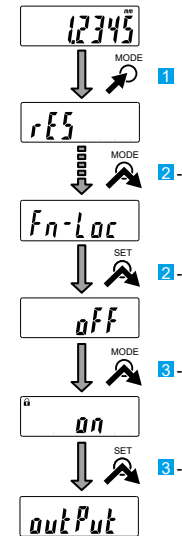

Tips

- The Function Lock function is executed after parameter-setup mode completes and the product returns to measurement mode.
- Release the Function Lock function to set any items for functions that are locked.

● Releasing the Function Lock function

1 Switch to parameter setting mode.

Press and hold the [MODE] key.

» The product enters parameter setting mode (function lock).

2 Confirm the parameter to set.

Briefly press the [SET] key.

» The Function Lock function can now be changed.

3 Change the Function Lock function.

1 Briefly press the [MODE] key to select release (off).

2 Briefly press the [SET] key.

» When the setting is confirmed, the next parameter can be set (proceeds to step 2 in "3) Changing the data output format").

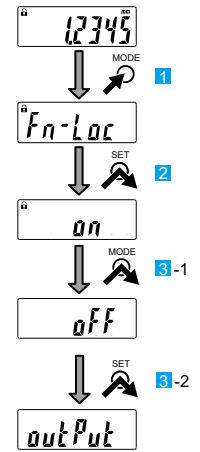

3) Changing the data output format

The data output format can be set to either 6 digits (out-d1) or 8 digits (out-d2). The parameter will be set to 6 digits (out-d1) after the battery is installed.

1 Switch to parameter setting mode.

Press and hold the [MODE] key.

» The product enters parameter setting mode.

2 Select the parameter to set.

1 Briefly press the [MODE] key until [outPut] is displayed.

2 Briefly press the [SET] key.

» The data output format can be set.

3 Set the data output format.

1 Briefly press the [MODE] key to select the data output format.

» Each time the key is pressed, the setting will change in the order of out-d1, out-d2, out-d1.

2 Briefly press the [SET] key.

» When the setting is confirmed, the next parameter can be set (proceeds to step 2 in "1) Changing the resolution").

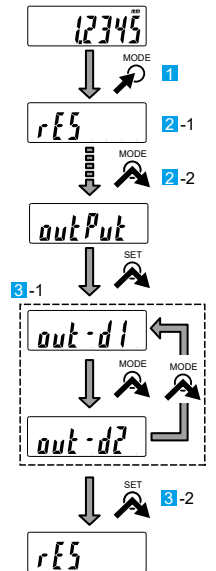

Tips

- When out-d1 is selected, the Digimatic output is 6 digits.
- When out-d2 is selected, the Digimatic 2 output is 8 digits.

9. Installing the Heat-Resistant Cover

Installing the supplied heat-resistant cover reduces the transmission of heat from one's hands to the frame when measuring while holding the product, and it can reduce the error caused by the heat expansion of the frame.



Always install and use the supplied heat-resistant cover when measuring while holding the product with your hands.

- 1 Install the heat-resistant cover from the bottom side of the product.
- 2 Tighten the securing screws (two places) with a Phillips screwdriver.

Tips

- To remove the heat-resistant cover, perform the installation procedure in the opposite order.
- Store the securing screws so that they are not lost.
- For details about measurement error due to temperature, see "13. Measurement Error Due to Temperature Fluctuations".

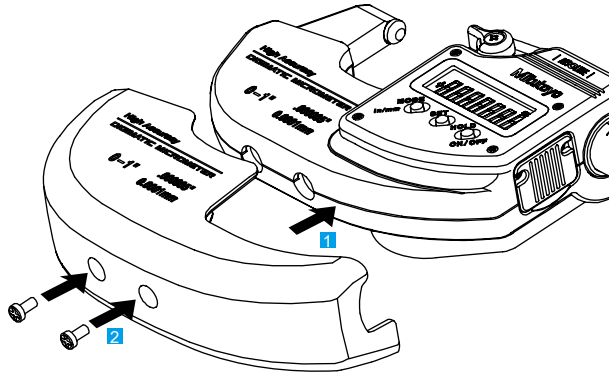

10. Errors and Troubleshooting

Error display	Causes and countermeasures
	The battery voltage is low. Replace the battery promptly.
	The measured value exceeds the number of digits that can be displayed. <ul style="list-style-type: none"> • For the ABS measurement system, press the [SET] key to enter setup for the measurement origin, and reset the preset value. • For the INC measurement system, press the [SET] key at the appropriate position to perform a zero set.
	The signal from the sensor has an abnormality. Try removing the battery and reinstalling. If it does not recover after being reset, repair is required: please contact the agent where you purchased the product or a Mitutoyo sales representative.
	The signal from the sensor has an abnormality. Try removing the battery and reinstalling. If it does not recover after being reset, repair is required: please contact the agent where you purchased the product or a Mitutoyo sales representative.
	The positional calculation is erroneous due to an abnormality in the signal from the sensor. Try removing the battery and reinstalling. If it does not recover after being reset, repair is required: please contact the agent where you purchased the product or a Mitutoyo sales representative.
	Internal settings are being rewritten due to the intrusion of oil, etc. Try removing the battery and reinstalling. If it does not recover after being reset, repair is required: please contact the agent where you purchased the product or a Mitutoyo sales representative.

11. Specifications

Measuring range:	0–25 mm 0–1 in (in/mm products only)
Resolution:	0.0001 mm (can be changed to 0.0005 mm) 0.000005 in (can be changed to 0.00002 in) (in/mm products only)
Maximum permissible error J_{MPE}^{*1} :	$\pm 0.5 \mu\text{m}$ ± 0.00002 in (in/mm products only)
Measuring force:	7 N–9 N
Display unit:	LCD (7-digit and minus sign)
Power:	Lithium battery (CR2032) x1
Battery life *2:	About two years
Temperature range:	20 °C (temperature of assured accuracy), 5 °C to 40 °C (operating temperature), -10 °C to 60 °C (storage temperature)
Standard accessories:	Heat-resistant cover (No.04AAB969A), wrench (No.200877), screwdriver (No.04AAB985), wiping sheet, inspection results
CE marking/UKCA marking:	EMC Directive/Electromagnetic Compatibility Regulations: EN 61326-1 Immunity test requirement: Clause 6.2 Table 2 Emission limit: Class B RoHS Directive/The Restriction of the Use of Certain Hazardous Substances in Electrical and Electronic Equipment Regulations: EN IEC 63000

*1: Maximum permissible error for indicated value via contact with the full measuring face J_{MPE} (20 °C).

*2: Under normal usage conditions. The battery life will fluctuate according to the usage conditions.

12. Output Function

Display Value External Output

The display value can be output to a device by connecting the product and the external device with a connecting cable (optional accessory).

Connecting Cable Installation Method

NOTICE Shows risks that could result in property damage.

- Always use the 0-size Phillips screwdriver (No.04AAB985) supplied with the product when installing/removing screws, and tighten with a torque of about 5 to 8 cN·m. Otherwise, it may cause damage.
- When connecting the connecting cable, ensure that the connector gasket does not protrude. If the connector gasket is not installed properly, it may lead to malfunction.

Tips

- The maximum number of digits this product can display is 7. Note that when using 6-digit output (out-d1) for the data output format, the data must be re-read. Also note that if 100 mm or more is displayed for the preset function, the digit in the position of the highest value will not be output.
- For in/mm products (resolution: 0.000005 in), the value after the decimal point is output as an integer value. (Example: A value displayed as "0.012345 in" will be output as "12345 in".)
- For in/mm products (resolution: 0.00002 in), if a measured value exceeding "10 in" is displayed for the preset function, the digit in the position of the highest value will not be output.
- The data output format will be set to 6 digits (out-d1) after the battery is installed.
- If connecting a peripheral device not compatible with 8-digit output, set the data output format to 6 digits (out-d1).
- If outputting to a peripheral device that is compatible with 8-digit output, set the data output format to 8 digits (out-d2).
- For details about changing the data output format, see "8. Setting the Parameters 3) Changing the data output format".

- 1 Use the Phillips screwdriver supplied with the connecting cable to remove the cover fixing screws (M1.7 x 0.35 x 4, No.04AAB541).
- 2 Remove the cover.
- 3 Check that the connector gasket (No.09GAA374) is correctly installed at the proper position (do not remove the connector gasket).
- 4 Mount the connecting cable plug.
- 5 Hold the plug manually so that there is no gap between the plug and the connector on the micrometer body, and fasten using the connecting cable fixing screws.

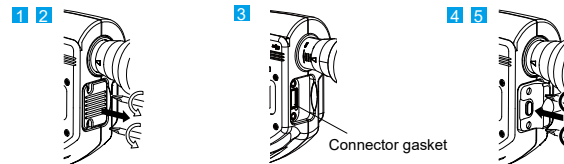

Output Data Format (When Set to 6 Digits)

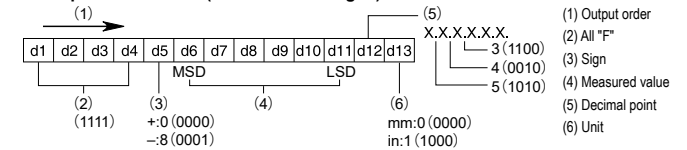

Output Data Format (When Set to 8 Digits)

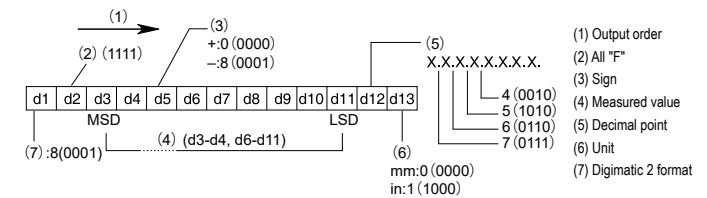

Timing Chart

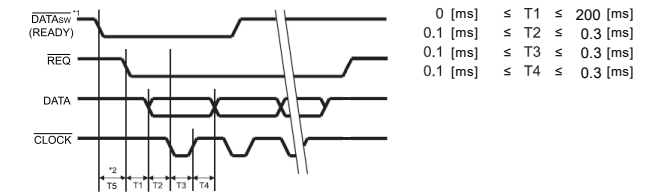

*1: DATAsw is LOW while the data output key is being pressed.

*2: The time T5 until DATAsw goes to the LOW level and REQ is input is determined by the data processing device performance.

13. Measurement Error Due to Temperature Fluctuations

Because the display resolution of this product is 0.1 μm , the measurement results will be affected by heat expansion of this product caused by temperature fluctuations.

Performing high-accuracy measurements with the stand installed is recommended. Always use the supplied heat-resistant cover when measuring while holding the product with your hands. Measured data under the following two conditions is provided below as a reference.

■ Measurement Error Due to Temperature Fluctuations When the Heat-Resistant Cover Is Used

Shows the effect on the frame using the supplied heat-resistant cover when measuring while holding the product with one's hands.

Measurement environment: Ambient temperature 20 $^{\circ}\text{C}$, humidity 50 %, measured at anvil position

① Without heat-resistant cover

② With heat-resistant cover

A. Holding time (minutes)

B. Extension (μm)

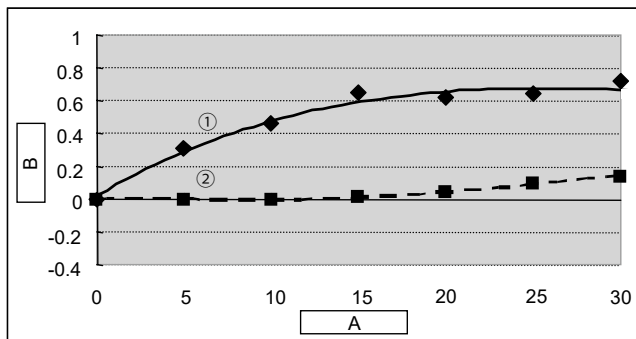

■ Amount of Displacement Due to Fluctuations in Ambient Temperature

If the ambient temperature of the measurement environment changes, the entire measuring tool will expand due to heat.

① Steel gauge block

② Zero-expansion glass

A. Environment temperature ($^{\circ}\text{C}$)

B. Displacement from 20 $^{\circ}\text{C}$ (μm)

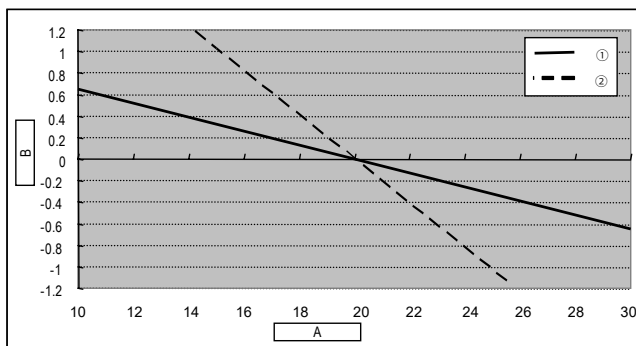

14. Optional Accessories

- Connecting cable: No.05CZA662 (1 m)
- Connecting cable: No.05CZA663 (2 m)
- Wiping sheet (1000 sheets): No.04AZB581

For optional accessories other than the above, see the General Catalog.

15. Off-Site Repairs (Subject to Charge)

Off-site repair (subject to charge) is required in the case of the following malfunctions. Please contact the agent where you purchased the product or a Mitutoyo sales representative.

- Faulty spindle operations
Scratches on the spindle may cause interference while the spindle is retracting, causing faulty operations. Rust on the spindle may also cause faulty operations.
- Inconsistent measured values
Burr or nicks generated by an impact on the measurement surfaces may affect measurement repeatability.
- Count value errors/faulty operations
If the thimble of this product is retracted too far, the internal sensor will be damaged. This may cause count errors or faulty operations.