



Digimatic Indicator ID-H

ID-H0530

ID-H0560

ID-H0530E

ID-H0560E

User's Manual

No. 99MAH065A

Date of publication: April 1, 2023

■ Product names and model numbers covered in this document

Product name	Model No.
Digimatic Indicator ID-H	ID-H0530 ID-H0560 ID-H0530E ID-H0560E



■ Notice regarding this document

- The contents of this document are based on information current as of April 2023.
- No part or whole of this document may be transmitted or reproduced by any means without prior written permission of Mitutoyo Corporation.
- Some screen displays in this document may be highlighted, simplified or partially omitted for convenience of explanation. In addition, some of them may differ from actual ones to the extent that no user will misunderstand the functions and operations.
- The corporation, organization and product names that appear in this document are their trademarks or registered trademarks.

©2023 Mitutoyo Corporation. All rights reserved.

CONVENTIONS AND WORDING USED IN THIS MANUAL

- Safety reminder conventions and wording warning against potential hazards

 DANGER	Indicates a hazard with a high level of risk which, if not avoided, will result in death or serious injury.
 WARNING	Indicates a hazard with a medium level of risk which, if not avoided, could result in death or serious injury.
NOTICE	Indicates a potentially hazardous situation which, if not avoided, may result in property damage.
	Flammable material Alerts the user to a specific hazardous situation that means "Caution, risk of igniting gas".

- Conventions indicating prohibited and mandatory actions

 Indicates concrete information about prohibited actions.	 Indicates concrete information about mandatory actions.
--	---



- Conventions and wording indicating referential information or reference location

IMPORTANT Indicates information that must be known when using this product.

Tips Indicates further information and details relevant for the operating methods and procedures that are explained in that section.



Indicates reference location if there is information that should be referred to in this document or an extraneous User's Manual.

Example: Refer to  "1.2 Names and Dimensions of Components" on page 2 for details on .

Safety Precautions

Read these "Safety Precautions" thoroughly before operating the product to use it properly.

These safety precautions include such information as to prevent injury to the operator and other persons, damage to property and product defects. Be sure to observe these precautions carefully.



Do not use the product in areas where volatile gases may be generated. There is a risk of igniting the gas.



Observe the following, since there is a risk of an electric shock or fire.

- The product is not to be repaired or modified by the users.



Observe the following, since there is a risk of an electric shock or fire.

- If the product starts to emit smoke or strange odors, etc. remove the DC plug immediately and disconnect the AC adapter from the electrical outlet, then contact the agent where you purchased the product or Mitutoyo sales/service representative.
- Use with the designated AC adapter.
- If the product is dropped or otherwise damaged, remove the DC plug and disconnect the AC adapter from the electrical outlet, then contact the agent where you purchased the product or Mitutoyo sales/service representative.
- Be sure to use the product specified in this document when an optional item is required.

Precautions for Use

■ Product applications and handling

- Do not apply excessive force or subject to sudden impacts such as when dropped.
- Do not write with an electric pen, etc. This may cause damage.
- Do not operate the keys with a pointed object (such as a screwdriver or ballpoint pen).
- Avoid using the plunger in such a way that it is subjected to perpendicular load or torsion.

■ Usage environment

- Avoid using or storing in places directly exposed to sunlight, or extremely hot or cold places.
- Use or storage in places with low or high atmospheric pressure may cause material deterioration, etc., leading to failure.
- Do not store the product in a place with high humidity. Also, avoid usage in places exposed to splashes of water or coolant.
- The product may malfunction if used in areas with high electrical noise.
- Securely fix to an optional comparator stand, etc., and use in a place where there is no vibration.
- Errors will result when used in places with significant temperature fluctuation, due to the thermal expansion of structural components and fixing jigs. Use in places with minimal temperature fluctuation. Allow the product to adapt to the ambient temperature when using in a location with a different temperature.
- For stable measurement, wait about 20 minutes after energizing. The base point may drift about 0.5 μm .

■ Maintenance

- Lightly wipe off dirt on this product with a lint-free soft cloth. Do not use organic solvents such as detergents, thinner or benzene.
- Dirt on the plunger or in the cylinder may lead to malfunction. Clean with a cloth moistened with alcohol, etc. before use.
Please clean inside the cylinder periodically. Rotate the cylinder to detach it, and use a brush or blow brush to remove any dirt or dust on the piston, around the piston, and inside the cylinder.
- Do not lubricate the plunger with lubricant or other oil.

■ Power supply

Do not connect this product to a power supply that is subjected to large currents such as those from machine tools, large CNC measuring devices, etc. A single connection is recommended.

Electromagnetic Compatibility (EMC)

This product complies with the EMC Directive and the UK Electromagnetic Compatibility Regulations. However, electromagnetic interference exceeding these requirements is out of warranty and appropriate countermeasures are required.

Warranty

This product has been manufactured under strict quality management, but should it develop problems within one year of the date of purchase in normal use, repair shall be performed free of charge. Please contact the agent where you purchased the product or a Mitutoyo sales/service representative ( "SERVICE NETWORK" on page App-1).

If this product fails or is damaged for any of the following reasons, it will be subject to a repair charge, even if it is still under warranty.

- Failure or damage owing to fair wear and tear
- Failure or damage owing to inappropriate handling, maintenance or repair, or to unauthorized modification
- Failure or damage owing to transport, dropping, or relocation of the product after purchase
- Failure or damage owing to fire, salt, gas, abnormal voltage, lightning surge, or natural disaster
- Failure or damage owing to use in combination with hardware or software other than those designated or permitted by Mitutoyo
- Failure or damage owing to use in ultra-hazardous activities

This warranty is effective only where the product is properly installed and operated in conformance with the instructions in this document within the original country of the installation.

EXCEPT AS SPECIFIED IN THIS WARRANTY, ALL EXPRESS OR IMPLIED CONDITIONS, REPRESENTATIONS, AND WARRANTIES OF ANY NATURE WHATSOEVER INCLUDING, WITHOUT LIMITATION, ANY IMPLIED WARRANTY OF MERCHANTABILITY, FITNESS FOR A PARTICULAR PURPOSE, NONINFRINGEMENT OR WARRANTY ARISING FROM A COURSE OF DEALING, USAGE, OR TRADE PRACTICE, ARE HEREBY EXCLUDED TO THE MAXIMUM EXTENT ALLOWED BY APPLICABLE LAW.

You assume responsibility for all results due to the selection of this product to achieve your intended results.

Disclaimer

IN NO EVENT WILL MITUTOYO, ITS AFFILIATED AND RELATED COMPANIES AND SUPPLIERS BE LIABLE FOR ANY LOST REVENUE, PROFIT, OR DATA, OR FOR SPECIAL, DIRECT, INDIRECT, CONSEQUENTIAL, INCIDENTAL, OR PUNITIVE DAMAGES HOWEVER CAUSED AND REGARDLESS OF THE THEORY OF LIABILITY ARISING OUT OF THE USE OF OR INABILITY TO USE THIS PRODUCT EVEN IF MITUTOYO OR ITS AFFILIATED AND RELATED COMPANIES AND/OR SUPPLIERS HAVE BEEN ADVISED OF THE POSSIBILITY OF SUCH DAMAGES.

If, notwithstanding the foregoing, Mitutoyo is found to be liable to you for any damage or loss which arises out of or is in any way connected with use of this product by you, in no event shall Mitutoyo's and/or its affiliated and related companies' and suppliers' liability to you, whether in contract, tort (including negligence), or otherwise, exceed the price paid by you for the product only. The foregoing limitations shall apply even if the above-stated warranty fails of its essential purpose.

BECAUSE SOME COUNTRIES, STATES OR JURISDICTIONS DO NOT ALLOW THE EXCLUSION OR THE LIMITATION OF LIABILITY FOR CONSEQUENTIAL OR INCIDENTAL DAMAGES. IN SUCH COUNTRIES, STATES OR JURISDICTIONS, MITUTOYO'S LIABILITY SHALL BE LIMITED TO THE EXTENT PERMITTED BY LAW.

About This Document

This document is intended to provide an overview of the product, the functions of each component, setup, usage and maintenance details.

How to read this document

4 Measurement Method ➡ (Short press) / ⇔ (Long press)

2 Turn ON tolerance judgment

- 1 Short press the [SET/ZERO] key
 - » The [oFF] display starts blinking.
- 2 Short press the [MODE] key
 - » Switches to the [on] display flashing.



Indicates an operating procedure to be performed or its outline.

Indicates specific work procedures.

3 Short press the [SET/ZERO] key to display the previously set upper limit value
(If not changing upper limit value proceed to step 5)

- » The previously set upper limit value (e.g.: default value 0.0000 mm) is displayed and [▶] starts blinking.



Indicates operation results.

4 Set the upper limit value
For details on setting the upper limit value, see "3.6 Display value preset" on page 18 (refer step 3).

5 Short press the [SET/ZERO] key to confirm the upper limit value and display the previously set lower limit value
(If not changing the lower limit value, proceed to step 7)

- » The previously set lower limit value (e.g.: default value 0.0000 mm) is displayed and [◀] starts blinking.



Indicates the reference location.

6 Set the lower limit value
For details on setting the lower limit value, see "3.6 Display value preset" on page 18 (refer step 3).

Tips
Long pressing the [MODE] key during tolerance setting returns to the state prior to the settings.

33 No. 99MAH065A

Indicates supplementary information.

■ Brackets, quotation marks and numbers (1, 1)

The meanings of brackets, quotation marks and numbers to be used in this document are as follows.

(): Round brackets	Represent a paraphrase of an immediately preceding phrase or a supplementary explanation.
" ": Double quotation marks	Represent a highlighted phrase. They also indicate an index where information to be referenced is described. Indicates specific work procedures.
[]: Square brackets	Represent an item (menu, dialog, button, tab, etc.) that appears on the screen, or key on the controller or keyboard. They also indicate an item to be purposely entered or selected by the customer.
1, 2, 3... 1, 2, 3...	Indicates the order and the contents of tasks. (1: indicates main tasks, 1: indicates detailed tasks)

■ Key notations

In this manual, the names of the keys to be pressed, their operations (length and number of times the key is pressed), and the progress directions of procedures are indicated by arrows.

E.g.: [MODE] key

[MODE] ➔	Press the [MODE] key briefly (press and release immediately)
[MODE] ➞	Press and hold the [MODE] key (2 seconds or more) and release it

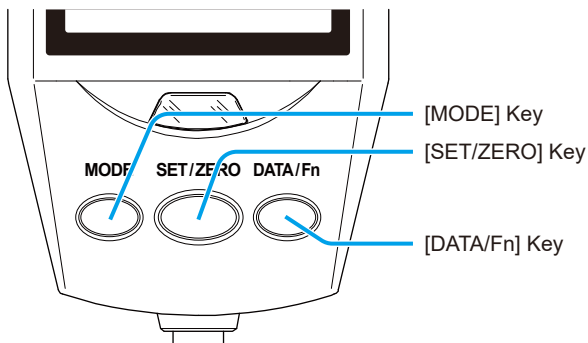

Contents

CONVENTIONS AND WORDING USED IN THIS MANUAL	i
Safety Precautions	ii
Precautions for Use.....	ii
Electromagnetic Compatibility (EMC)	iii
Warranty.....	iv
Disclaimer.....	v
About This Document	vi
Contents	viii
1 Overview.....	1
1.1 Overview of This Product	1
1.2 Names and Dimensions of Components	2
1.2.1 Main Unit	2
1.2.2 Display (LCD)	4
1.2.3 Standard Accessories.....	5
2 Preparations before Use.....	7
2.1 Contact Point Replacement	7
2.2 Mounting to a Comparator Stand/Jig	8
2.2.1 Mounting by Stem.....	8
2.2.2 Installing with Various Backs	9
2.3 Mounting the Lifting Lever and Release	10
2.3.1 Lifting Lever.....	10
2.3.2 Release (Optional).....	11
2.4 Mounting the Clamp Filter	12
2.5 Connecting the AC Adapter	13
2.6 Connecting with External Devices	14

3	Basic Use.....	15
3.1	Power ON/OFF	15
3.2	Switching the Unit of Measurement	16
3.3	Switching Measurement Systems	16
3.4	Zero Setting Displayed Values	17
3.5	Display Value Hold	17
3.6	Display Value Preset	18
3.7	Setting Function Lock	20
3.8	Pointer Centering.....	21
3.9	Operation via Remote Controller (Optional)	22
4	Measurement Method	23
4.1	Normal Measurement	24
4.1.1	Incremental Measurement (INC)	24
4.1.2	Absolute Measurement.....	25
4.2	Peak Value Measurement	26
4.2.1	Runout Width (TIR) Mode.....	26
4.2.2	Maximum Value (Max) Mode.....	28
4.2.3	Minimum Value (Min) Mode.....	30
4.3	Tolerance Judgment	32
4.3.1	Tolerance Judgment Implementation.....	32
4.3.2	Cancelling Tolerance Judgment	34
4.4	Digimatic (SPC) Output of Displayed Values	35
5	Setting Parameters.....	37
5.1	List of Parameters	37
5.2	Changing Parameters	38
5.2.1	Parameter Selection.....	38
5.2.2	Changing Setting Details.....	38



6	Precautions after Use.....	43
7	Error Displays and Countermeasures	45
8	Data I/O	47
8.1	I/O Format Switching	47
8.2	SPC (Digimatic) I/O Specifications	48
8.2.1	I/O Connector	48
8.2.2	Output Data Format (DATA1)	49
8.2.3	Timing Chart	49
8.3	RS-232 Communication I/O Specifications	50
8.3.1	I/O Connector	50
8.3.2	Communication Specifications	50
8.3.3	Communication Commands (I/O Format).....	51
9	Specifications	55
9.1	Specifications	55
9.2	Standard Accessories	57
9.3	Accessories (Optional)	57
10	Off-Site Repairs (Subject to Charge).....	59
	SERVICE NETWORK	App-1

1 Overview

1.1 Overview of This Product

This product is a high-precision, high-performance Digimatic indicator that digitally displays the amount of displacement of the plunger.

It has the following features.

- It is equipped with a backlight display function for tolerance judgment results. (Refer to  "4.3 Tolerance Judgment" on page 32.)
- It can hold the peak values of the displaced measured values (runout, maximum value, minimum value). (Refer to  "4.2 Peak Value Measurement" on page 26.)
- It provides an analog bar display that makes it easy to check the approach to the origin and tolerance values. (Refer to  "1.2.2 Display (LCD)" on page 4.)

1.2 Names and Dimensions of Components

1.2.1 Main Unit

30.48 mm stroke model

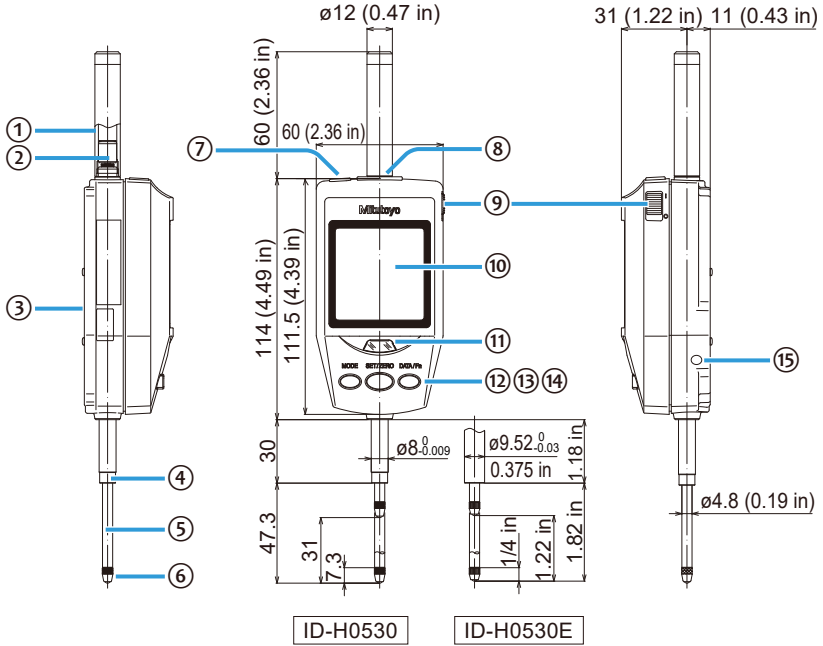

Unit: mm (in)

①	Cylinder (outside)	⑧	I/O connector
②	Piston (inside)	⑨	Power switch
③	Lug mounting screws	⑩	LCD display
④	Stem	⑪	Remote controller receiver window
⑤	Plunger	⑫	[MODE] key
⑥	Contact Point ISO/JIS type: No. 901312 AGD type: No. 21BZB005	⑬	[SET/ZERO] key
		⑭	[DATA/Fn] key
⑦	DC jack	⑮	Release mounting hole

1 Overview

60.96 mm stroke model

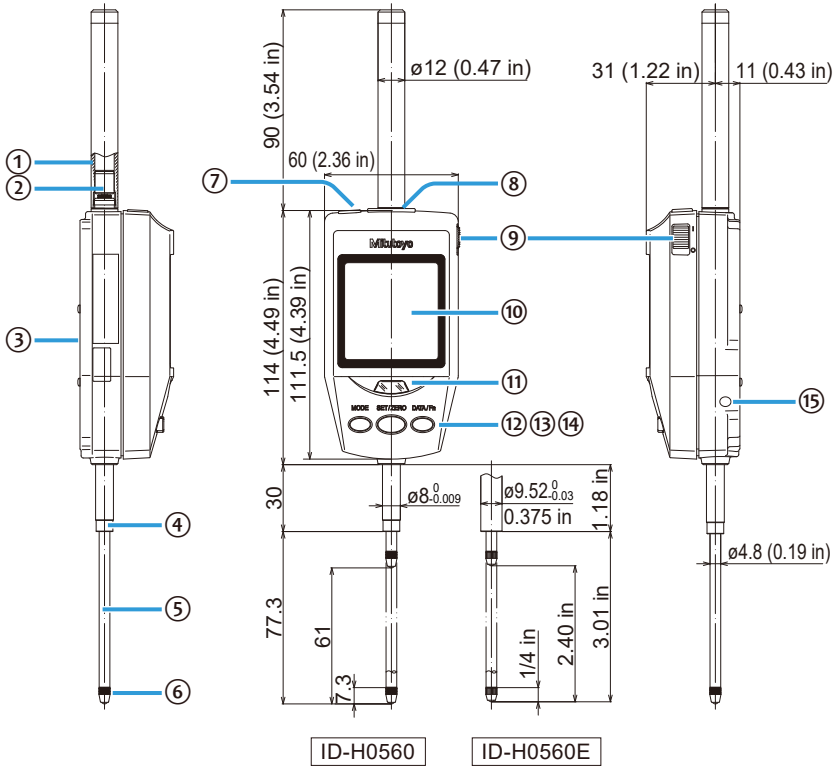

Unit: mm (in)

①	Cylinder (outside)	⑧	I/O connector
②	Piston (inside)	⑨	Power switch
③	Lug mounting screws	⑩	LCD display
④	Stem	⑪	Remote controller receiver window
⑤	Plunger	⑫	[MODE] key
⑥	Contact Point ISO/JIS type: No. 901312 AGD type: No. 21BZB005	⑬	[SET/ZERO] key
		⑭	[DATA/Fn] key
⑦	DC jack	⑮	Release mounting hole

1.2.2 Display (LCD)

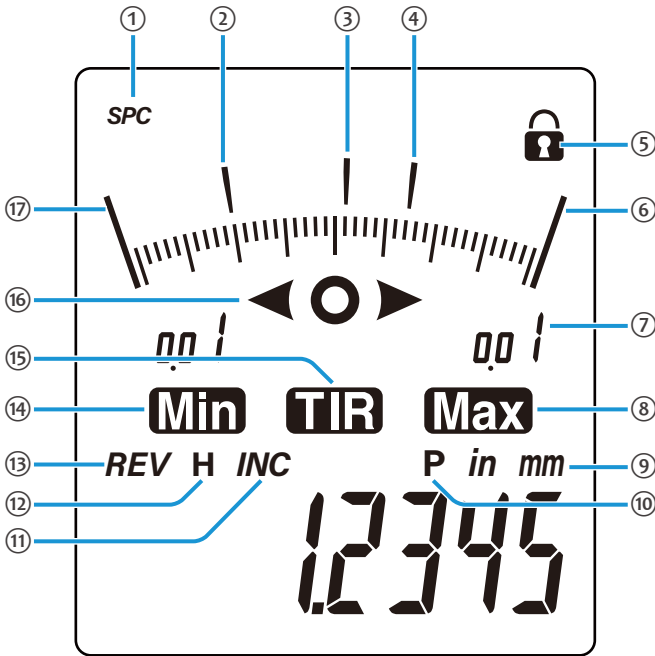

①	Output format display	⑩	Preset settings
②	Lower pointer	⑪	Incremental measurement
③	Pointer	⑫	Data hold
④	Upper pointer	⑬	Reverse counting (minus count)
⑤	Function lock	⑭	Peak value measurement: minimum value (Min)
⑥	Upper over range	⑮	Peak value measurement: runout width (TIR)
⑦	Analog range	⑯	Tolerance judgment
⑧	Peak value measurement: maximum value (Max)	⑰	Lower over range
⑨	Display unit		

1.2.3 Standard Accessories

■ AC adapter

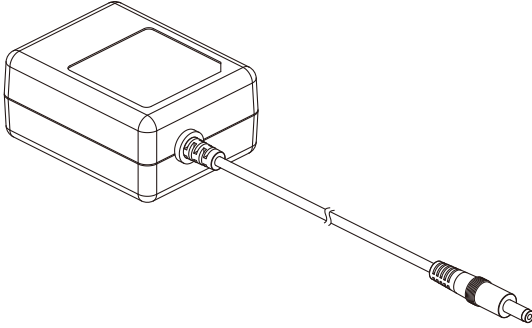

■ Clamp filter (ferrite core)

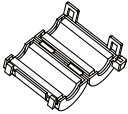

NOTICE

The clamp filter must be attached to the AC adapter.

For installation instructions, refer to  "2.4 Mounting the Clamp Filter" (page 5).

■ Lifting lever (finger hook)



■ Quick start guide

■ Safety precautions (including warranty)

■ Certificate of inspection

MEMO

2 Preparations before Use

2.1 Contact Point Replacement

When replacing the contact point, prepare two sets of pliers.

Various contact points are available as options. For details, refer to the Measuring Instruments Catalog.

NOTICE

During contact point replacement, fix the plunger and turn the contact point. Otherwise, the product may be damaged.

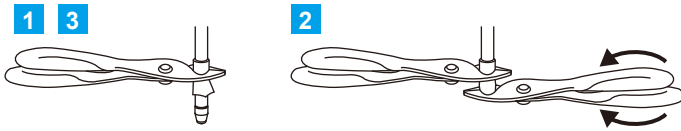

- 1** Cover the area near the contact point and plunger with a rag, and clamp the plunger with pliers, etc.
- 2** Hold the contact point with another pair of pliers from the top of the cloth and remove the contact point.
- 3** Install a new contact point in the same manner as removal.

Tips

- Changing the contact point may cause changes in external dimensions and measuring force, or restrictions on the possible measurement directions.
- Errors due to the contact point (perpendicularity of flat contact point, center runout of roller contact point, etc.) are added to the measurement accuracy.

2.2 Mounting to a Comparator Stand/Jig

2.2.1 Mounting by Stem

When this product is attached to a comparator stand (optional) or other device for measurement, attach the stem to the stand holder.

NOTICE

Whenever possible, avoid fixing the stem directly with a set screw, etc.

The plunger may not be able to move if the screw is tightened with a tightening torque of 150 cN · m or more.

IMPORTANT

Fix the plunger perpendicular to the reference plane and surface to be measured. If the axis (plunger) is not perpendicular to the reference plane (measurement plane), an error will be added to the measured value.

For example, the error δ per 30 mm of measurement length at an inclination angle ψ of the axis from the reference plane is:

$$\psi = 1^\circ : \delta = 0.0045 \text{ mm}, \psi = 2^\circ : \delta = 0.0185 \text{ mm}, \psi = 3^\circ : \delta = 0.0410 \text{ mm}.$$

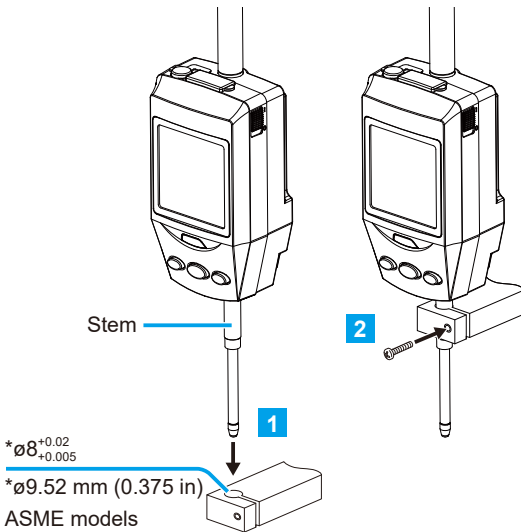

Tips

Use a slotted holder with a * $\phi 8$ G7 (+0.005 to +0.02) mm hole for the holder/stand.

*ASME models: $\phi 9.52 \text{ mm (0.375 in)}$

1 Mount stem to comparator stand or other holder.

2 Tighten the holder screws.

2.2.2 Installing with Various Backs

Various backs (optional) for dial gage can be used to secure the product to the jig. For details on various backs, refer to the Measuring Instruments Catalog.

IMPORTANT

Fix the plunger perpendicular to the reference plane and surface to be measured. If the axis (plunger) is not perpendicular to the reference plane (measurement plane), an error will be added to the measured value.

For example, the error δ per 30 mm of measurement length at an inclination angle ψ of the axis from the reference plane is:

$\psi = 1^\circ : \delta = 0.0045 \text{ mm}$, $\psi = 2^\circ : \delta = 0.0185 \text{ mm}$, $\psi = 3^\circ : \delta = 0.0410 \text{ mm}$.

E.g.: Back with lug

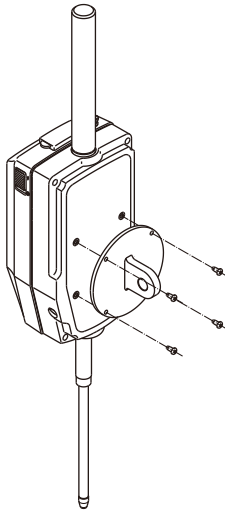

- 1** Remove the screws on the back (4 locations) using a Phillips screwdriver (No. 0).
- 2** Attach the back to the back mounting surface with the screws removed in **1**.
- 3** Secure the back to the jig.

2.3 Mounting the Lifting Lever and Release

Lifting lever (standard accessory) and release (optional) can be mounted.

2.3.1 Lifting Lever

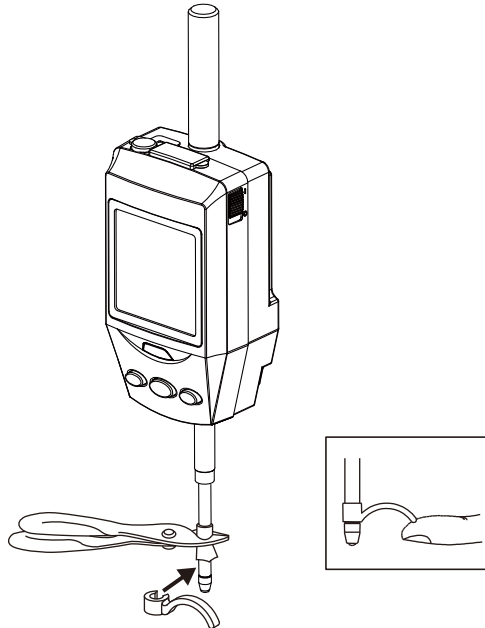

- 1** Secure the plunger with pliers, etc. using a rag to prevent it from turning.
- 2** Insert lifting lever into the plunger.
- 3** Rotate the lifting lever to adjust the orientation.

2.3.2 Release (Optional)

NOTICE

- Always mount the rubber cap if a release is not mounted.
- The product may be damaged if an item other than the release is inserted or if excessive force to push in is applied.
- Moving the plunger up or down while the release is loose may damage internal components or the workpiece.

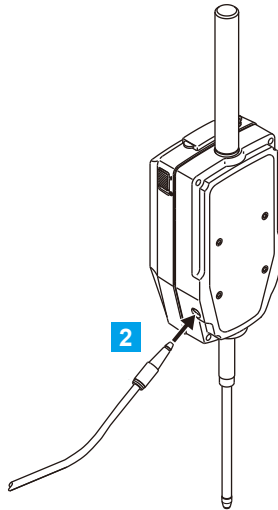

1 Remove the rubber cap from the release mounting hole by turning it.

2 Screw the release firmly into the hole.

Tips

- Store the removed rubber cap to prevent loss.
- The amount of plunger movement by release is about 30 mm from the bottom dead center.

2.4 Mounting the Clamp Filter

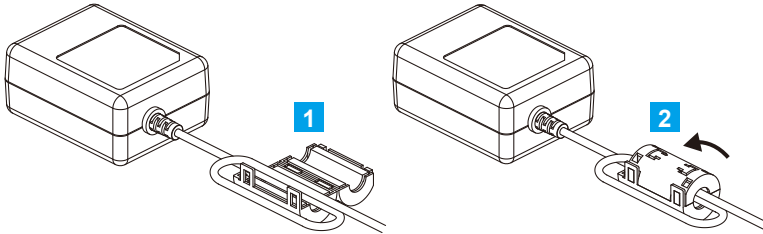

- 1** Wrap the AC adapter cord tightly around the clamp filter.
- 2** Close the clamp filter.

2.5 Connecting the AC Adapter

The main unit is powered via the AC adapter (part no. 06AGZ369JA, 06AGZ369D, 06AGZ369E, 06AGZ369K, 06AGZ369DC), which is a standard accessory.

NOTICE

- Be sure to use the AC adapter specified by our company. Failure to do so may result in malfunction.
Plug for Japan and North America (Part No. 06AGZ369JA)
Plug for Europe (Part No. 06AGZ369D)
Plug for UK (Part No. 06AGZ369E)
Plug for Korea (Part No. 06AGZ369K)
Plug for China (Part No. 06AGZ369DC)
- When connecting this product to a power supply or disconnecting it from a power supply, be sure to turn the power switch OFF. Doing so while it is ON may cause a malfunction inside the product.

1 Open the DC jack cover.

2 Firmly insert the DC plug of the AC adapter with the clamp filter attached into the DC jack of the main unit.

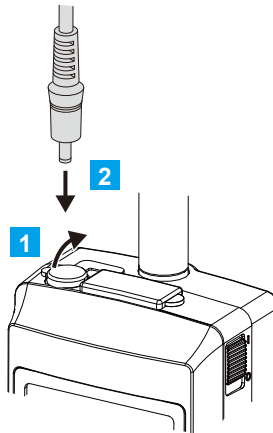



2.6 Connecting with External Devices

Displayed values can be output by connecting to an external device (external display, external printer, PC, etc.) using the optional connection cable or RS-232 connection cable.

NOTICE

Do not pull the connection cable with force. This may cause damage. When removing the connection cable, hold the plug at the tip.

Tips

- Refer to  "9.3 Accessories (Optional)" on page 57 for optional cables that can be connected to this product.
- Refer to  "8 Data I/O" on page 47 for details on connection cable pin assignments, the output data formats, and the timing chart.
- Store the removed output connector cover to prevent loss. Always install the cover if the cable is not connected.

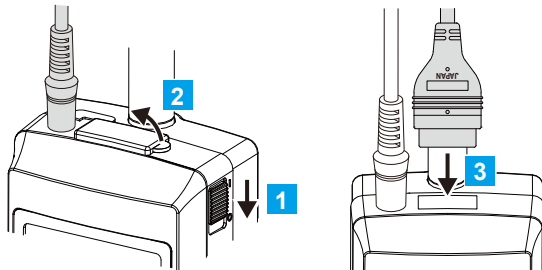

1 Slide the power supply switch down.

» Power turns OFF.

2 Remove the cover of the I/O connector of this product.

3 Connect the connection cable or RS-232 connection cable to this product.

IMPORTANT

When connecting, insert the connector firmly, paying attention to the direction of the connector.

4 Connect the other end to the external device.

3 Basic Use

IMPORTANT

- Acclimate the product and the workpiece to the ambient temperature sufficiently before starting measurement to minimize temperature fluctuations during measurement as much as possible.
- For stable measurement, wait about 20 minutes after energizing. The base point may drift about 0.5 μm .
- Do not set both ends of the plunger stroke as datum points.
- Dust, mist, etc. may enter through the gap between the plunger and the main unit, causing malfunction or failure. Avoid using the product in very dusty or misty environments.

3.1 Power ON/OFF

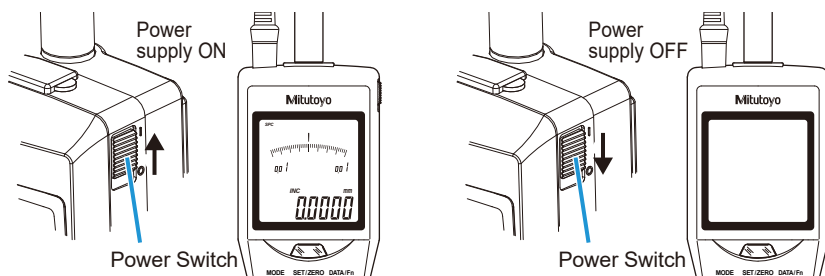

● Turning the power ON

Slide the power supply switch up

- » LCD display lights up.

● Turn the power supply OFF

Slide the power supply switch down

- » The LCD display turns off.

Tips

- The length measurement system (INC / stop time setting) can be switched when the power supply is turned on.
For details, refer to " ■ [start]: Switches the length measurement system at startup" on page 41.
- Turning the power OFF while making settings will cancel the setting and return the product to the status before setting.

3.2 Switching the Unit of Measurement

Change the setting parameters to switch the unit of measurement.

For details, refer to 📖 "5 Setting Parameters" on page 37.

3.3 Switching Measurement Systems

This product can switch between the following two measurement systems according to the workpiece to be measured.

- Incremental measurement (INC):
Sets the reference point on the master to serve as a reference (zeros the displayed value), and then measures the difference between the master and a workpiece.
- Absolute measurement:
Sets (presets) the measurement origin and measures the dimensions of the workpiece. The origin can be set to any desired value to support a wide range of workpieces.

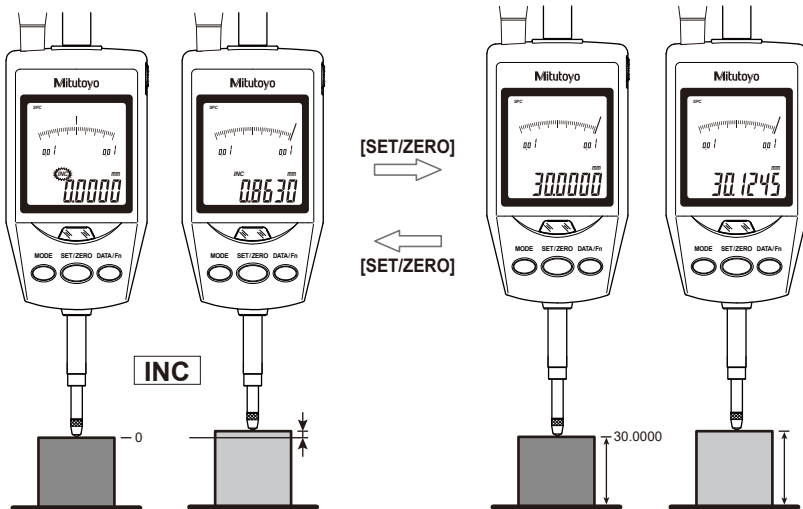

1 Long press the [SET/ZERO] key.

Switches between incremental measurement (INC) and absolute measurement.

- » [INC] on the LCD display turns off (when switched to absolute measurement).
- » [INC] on the LCD display lights up (when switched to incremental measurement).

Tips

Note that the displayed value is simultaneously reset to zero when switching from absolute measurement to incremental measurement (INC).

3.4 Zero Setting Displayed Values

Zero set the displayed values during incremental measurement (INC).

1 Short press the [SET/ZERO] key.

» Displayed value is reset to zero.

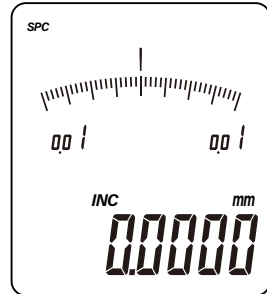

3.5 Display Value Hold

Holds (fixes) the displayed value.

This operation is enabled only when this product is not connected to an external device.

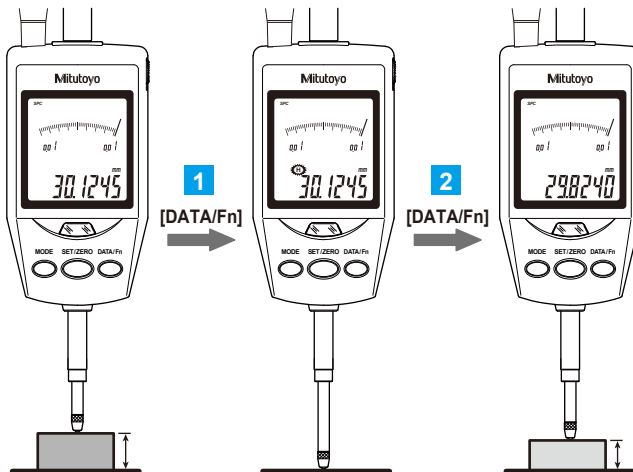

1 Short press the [DATA/Fn] key.

» The hold display ([H]) lights up and the displayed value is held (the displayed value is retained even if the workpiece is removed).

2 Short press the [DATA/Fn] key while holding the display value.

- » The hold display ([H]) turns off and the hold is released (current plunger position is displayed).

3.6 Display Value Preset

The display value can be preset to any value to set the value of the measurement origin for absolute measurement and the upper and lower tolerance limits used for tolerance judgment.

Tips

- The preset values are retained even when the power supply is turned OFF. However, they will be cleared when all reset is performed, so please set them again.
- The preset value is automatically converted when the unit system or resolution is changed. In this case, however, a conversion error may be produced. It is therefore recommended to check the preset value after changing the unit system or resolution.
- Press and hold the [MODE] key to cancel the preset setting.

This section describes the procedure for presetting the measurement origin value for absolute measurement.

1 Confirm that absolute measurement is activated ([INC] display is unlit).

When [INC] display is lit, long press the [SET/ZERO] key to switch to absolute measurement ([INC] display is unlit).



2 Short press the [SET/ZERO] key to start preset settings.

- » The previously set presets are displayed. (e.g.: 10.0000 mm)

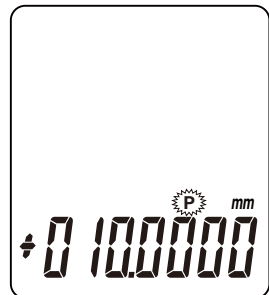

3 Change Presets.

(If not changing, proceed to step **4**)

- 1** Long press the [SET/ZERO] key.
 - » The sign will blink and the preset can be changed.
- 2** Short press the [MODE] key.
 - » Each time the key is pressed, it will switch the sign (+/-).
- 3** Short press the [SET/ZERO] key.
 - » The sign is confirmed and the neighboring digit blinks.
- 4** Short press the [MODE] key.
 - » Each time the key is pressed, the value will increase by one.
 - » Short press the [SET/ZERO] key.
 - » The number is confirmed and the neighboring digit blinks.
- 5** Repeat steps **4** to **5** above until the numbers for all digits are confirmed.
 - » Confirming the last digit will cause preset display ([P]) to blink.

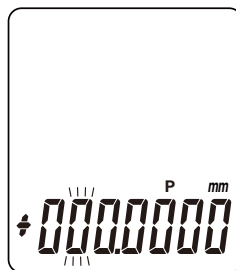
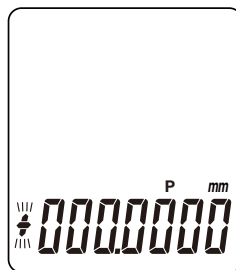

Tips

- Holding down the [DATA/Fn] key and short pressing the [SET/ZERO] key switches the digits in reverse order.
- Holding down the [DATA/Fn] key and short pressing the [MODE] key switches the values in reverse order.

4 Short press the [SET/ZERO] key to exit preset settings.

- » The preset display turns off, and presets are set.

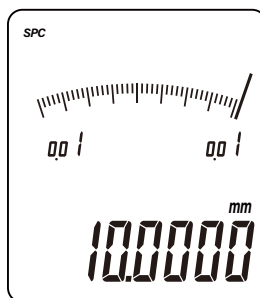

3.7 Setting Function Lock

This function is designed to prevent key mishandling.

When the function lock is set, the function lock display () lights up on the display, and operations other than power supply ON/OFF, peak value reset, display value hold/release, display value output, and function lock function release are disabled.

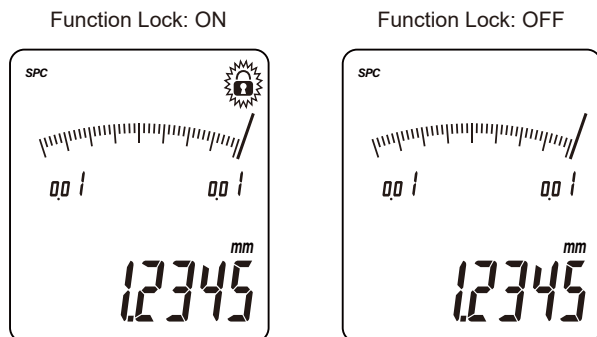

● Turns ON the function lock

Long press the [DATA/Fn] key while in each mode during measurement.

- » The function lock display () is lit, and the function lock turns ON.

● Turn OFF function lock

Long press the [DATA/Fn] key

- » The function lock display () is unlit, and the function lock turns OFF.

Tips

When the power supply of this product is turned OFF, the function lock is also automatically turned off.

3.8 Pointer Centering

Moves the display position of the pointer to the center of the scale.

- During normal measurement, the current measurement position is set at the center of the scale.

It is the same meaning as shifting the outer border to any desired scale on a dial gage.

- For peak value measurement,

use Runout (TIR) mode: The center position of the runout range is set at the center of the scale.

Maximum value (Max) mode: Sets the maximum value to the center of the scale.

Minimum value (Min) mode: Sets the minimum value to the center of the scale.

1 Short press the [SET/ZERO] key while holding down the [DATA/Fn] key.

» The pointer moves to the center of the scale.

Normal Measurement

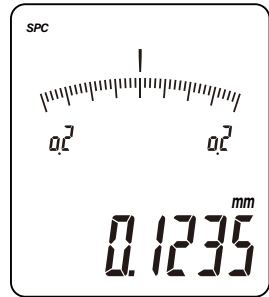

Peak Value Measurement
Runout (TIR) Mode

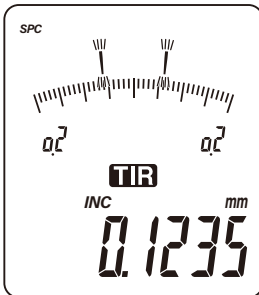

Peak Value Measurement
Maximum (Max) Mode

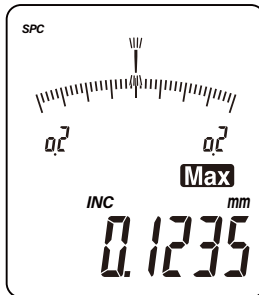

Peak Value Measurement
Minimum (Min) Mode

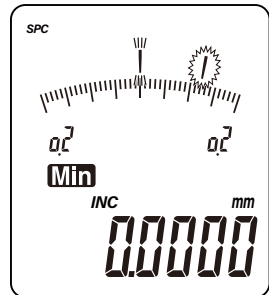

3.9 Operation via Remote Controller (Optional)

This product can be operated using an optional remote controller.

- Up to 14 combinations of this product and remote controller units can be identified and operated by setting the ID No.
Refer to " ■ [id]: Sets ID No. for RS-232 communication and remote controller" on page 41 for details on how to set the ID No.
- Data hold is valid only when SPC (Digimatic output) is set.
- When the function lock is engaged, zero setting, preset, and measurement mode switching are not accepted.

● Remote controller switch function list

[SET] switch

Absolute Measurement:	Preset recall (calling preset values)
Incremental Measurement (INC):	Zero setting
Peak Value Measurement:	Reset peak values (start new peak detection)

[DATA] switch

When no external device is connected:	Display value hold
When connected to an external device:	Data output

[MODE] switch: Switching modes during measurement

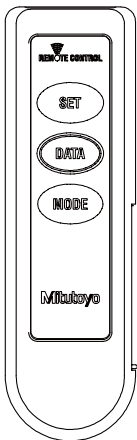

4 Measurement Method

This product has the following five measurement modes.

Each time the [MODE] key is short pressed, the mode is switched.

(① → ② → ③ → ④ → ⑤ → ①)

① Normal Measurement ② Tolerance Judgment ON/OFF

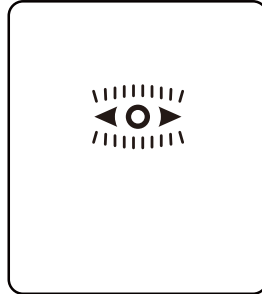
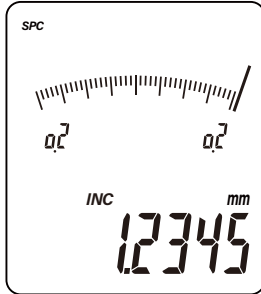

Performs normal measurement. Switches tolerance judgment
 • Incremental Measurement (INC) ON/OFF.
 • Absolute Measurement

③ Peak Value Measurement Runout (TIR) Mode ④ Peak Value Measurement Maximum (Max) Mode ⑤ Peak Value Measurement Minimum (Min) Mode

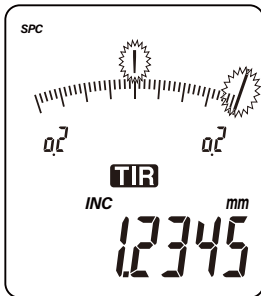

Detects displacement of the measured value and displays (holds) the amplitude (maximum value - minimum value).

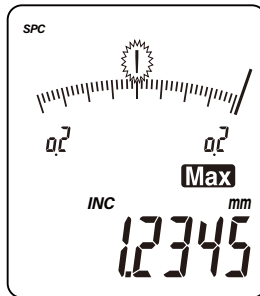

Detects displacement of the measured value and displays (holds) the maximum value.

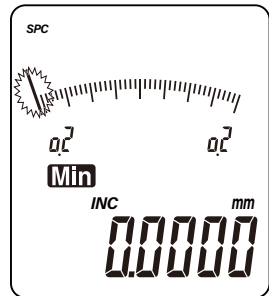

Detects displacement of the measured value and displays (holds) the minimum value.

NOTICE

Measurements should be taken with the plunger raised at least 0.2 mm from the bottom dead center.

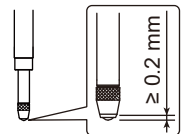

4.1 Normal Measurement

4.1.1 Incremental Measurement (INC)

Zeros the dimensions of the master to use as reference and measures the dimensional difference with the workpiece.

To perform tolerance judgment, turn ON tolerance judgment.

For details, refer to  "4.3 Tolerance Judgment" on page 32.

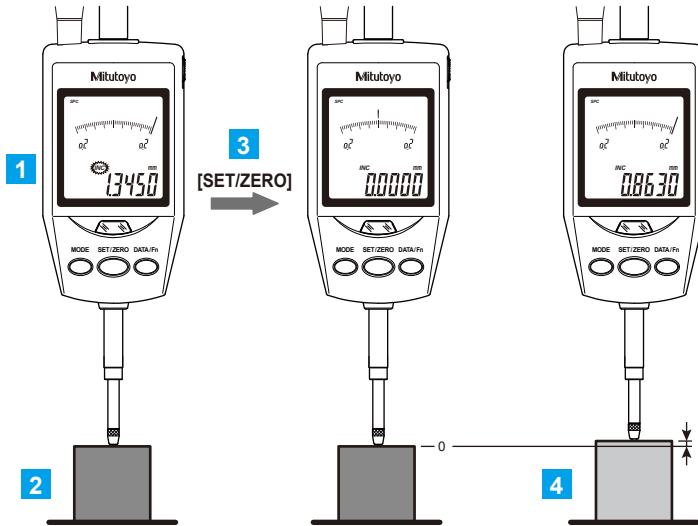

1 Confirm that the incremental measurement ([INC] display is lit).

If the [INC] display is off, long press the [SET/ZERO] key to switch to incremental measurement ([INC] display is lit).

2 Set the master to use for reference.

3 Short press the [SET/ZERO] key.

» The displayed value is set to zero.

4 Replace the master with the workpiece and perform incremental measurement.

4.1.2 Absolute Measurement

Set the dimensions of the master to preset values, and measure the dimensions of the workpiece.

To perform tolerance judgment, turn ON tolerance judgment.

For details, refer to 📖 “4.3 Tolerance Judgment” on page 32.

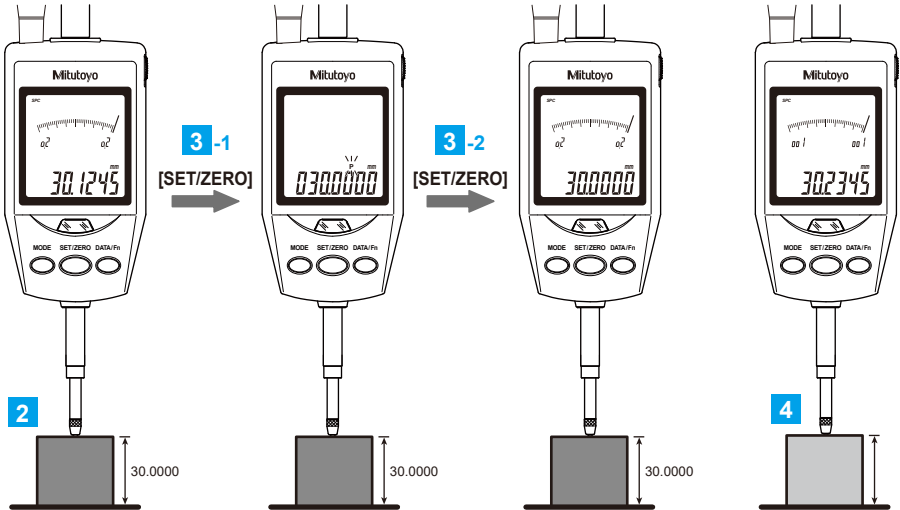

1 Confirm that absolute measurement is activated ([INC] display is unlit).

When [INC] display is lit, long press the [SET/ZERO] key to switch to absolute measurement ([INC] display is unlit).

2 Set the master to use for reference.

3 Setting the origin (origin point)

1 Short press the [SET/ZERO] key.

- » The preset display ([P]) blinks, and the previously set preset value (e.g.: 30.0000 mm) is displayed.

To change preset values, refer to 📖 “3.6 Display Value Preset” on page 18.

2 Confirm the preset value and short press the [SET/ZERO].

- » The measurement origin is set to the preset value, enabling absolute measurement.

4 Replace the master with the workpiece and perform absolute measurement.

4.2 Peak Value Measurement

In peak value measurement, the measurement is performed by moving and rotating the workpiece with the contact point. The displacement of the measured value is detected and displayed (held) as the amplitude (TIR), maximum value (Max), and minimum value (Min).

4.2.1 Runout Width (TIR) Mode

Detects displacement of the measured value and displays (holds) the "runout width (maximum value - minimum value)."

1 Short press the [MODE] key to display [TIR].

Each time the key is short pressed, the mode changes.
(Normal Measurement → Tolerance Judgment ON/OFF →
Runout Width → Maximum Value → Minimum Value →)

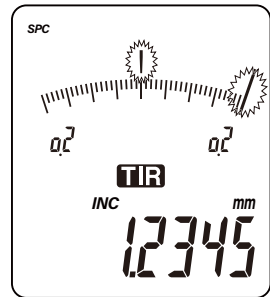

2 Touches the contact point with the workpiece.

3 Short press the [SET/ZERO] key.

- » The [TIR] display starts blinking.

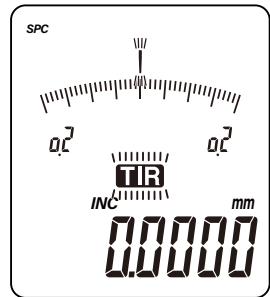

4 Move the plunger to measure the runout width.

- » When the plunger moves, the [TIR] display changes to lit and the runout width is held.
- » If tolerance judgment is selected, judgment results are displayed.

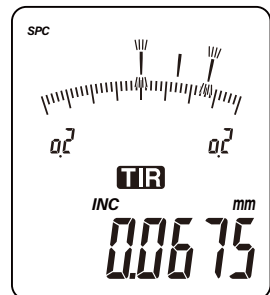

Tips

To start a new peak detection, short press the [SET/ZERO] key to reset the detected peak value.

Short press the [MODE] key to switch to another peak detection display (maximum or minimum value).

(Runout Width → Maximum Value → Minimum Value → Normal Measurement → Tolerance Judgment ON/OFF →)

● Display transition: Runout width (TIR) mode

When tolerance judgment is turned ON, the judgment result is displayed by comparing the runout width with the set upper and lower tolerance range.

E.g.: Upper limit tolerance UTL (8.0000 mm), Lower limit tolerance LTL (-3.0000 mm)

For details, refer to 📖 "4.3 Tolerance Judgment" on page 32.

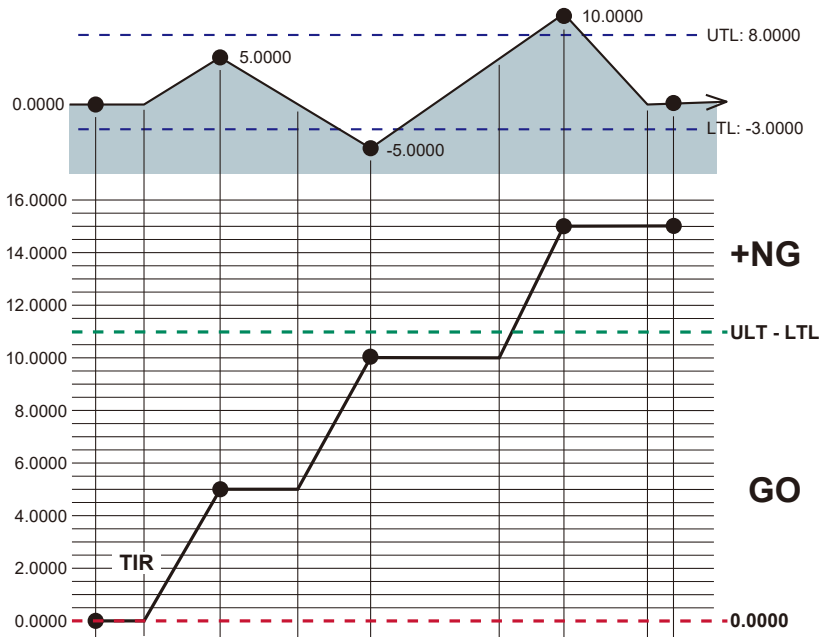

4.2.2 Maximum Value (Max) Mode

Detects displacement of the measured value and displays (holds) the "maximum value."

During absolute measurement, long pressing the [SET/ZERO] key sets the position of the maximum value to the datum [0.0000] (peak zero set) and switches to incremental measurement.

1 Short press the [MODE] key to display [Max].

Each time the key is short pressed, the mode changes.

(Normal Measurement → Tolerance Judgment ON/OFF → Runout Width → Maximum Value → Minimum Value →)



2 Touches the contact point with the workpiece.

3 Short press the [SET/ZERO] key.

- » The [Max] display starts blinking.

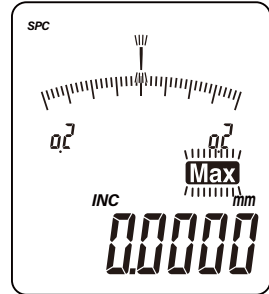

4 Move the plunger to measure the maximum value.

- » When the plunger moves, the [Max] display changes to lit and the maximum value is held.
- » If tolerance judgment is selected, judgment results are displayed.



Tips

To start a new peak detection, short press the [SET/ZERO] key to reset the detected peak value.

Short press the [MODE] key to switch to another peak detection display (minimum value or runout width).

(Maximum Value → Minimum Value → Normal Measurement → Tolerance Judgment ON/OFF → Runout Width →)

● Display transition: Maximum value (Max) mode

When tolerance judgment is turned ON, the judgment result is displayed for the maximum value.

E.g.: Upper limit tolerance UTL (8.0000 mm), Lower limit tolerance LTL (-3.0000 mm)

For details, refer to 📖 "4.3 Tolerance Judgment" on page 32.

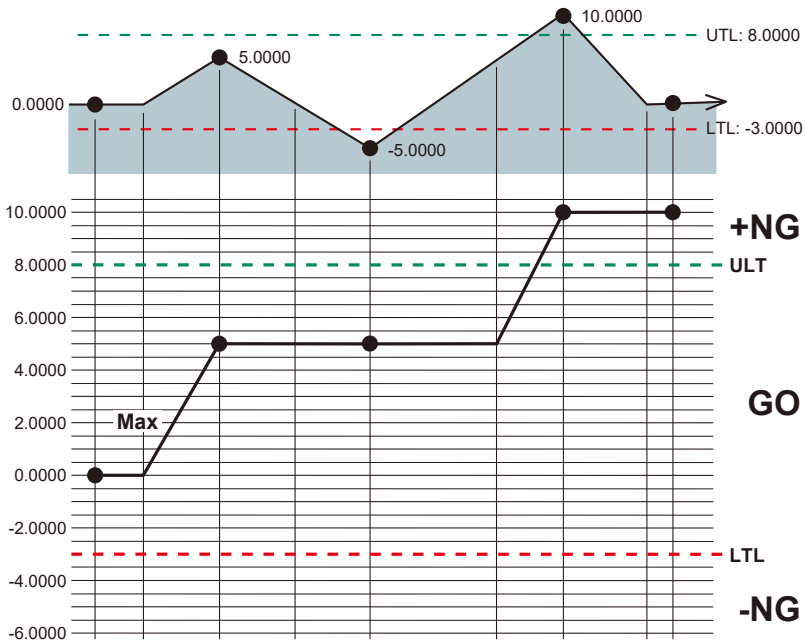

4.2.3 Minimum Value (Min) Mode

Detects displacement of the measured value and displays (holds) the "minimum value."

During absolute measurement, long pressing the [SET/ZERO] key sets the position of the minimum value to the datum [0.0000] (peak zero set) and switches to incremental measurement.

1 Short press the [MODE] key to display [Min].

Each time the key is short pressed, the mode changes.
(Normal Measurement → Tolerance Judgment ON/OFF →
Runout Width → Maximum Value → Minimum Value →)

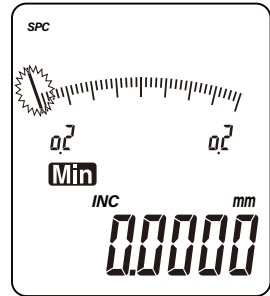

2 Touches the contact point with the workpiece.

3 Short press the [SET/ZERO] key.

- » The [Min] display starts blinking.

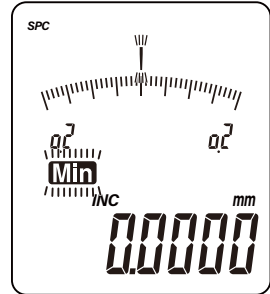

4 Move the plunger to measure the minimum value.

- » When the plunger moves, the [Min] display changes to lit and the minimum value is held.
- » If tolerance judgment is selected, judgment results are displayed.



Tips

To start a new peak detection, short press the [SET/ZERO] key to reset the detected peak value.

Short press the [MODE] key to switch to another peak detection display (minimum value or runout width).

(Minimum Value → Normal Measurement → Tolerance Judgment ON/OFF → Runout Width → Maximum Value →)

● **Display transition: Minimum value (Min) mode**

When tolerance judgment is turned ON, the judgment result is displayed for the minimum value.

E.g.: Upper limit tolerance UTL (8.0000 mm), Lower limit tolerance LTL (-3.0000 mm)

For details, refer to 📖 "4.3 Tolerance Judgment" on page 32.

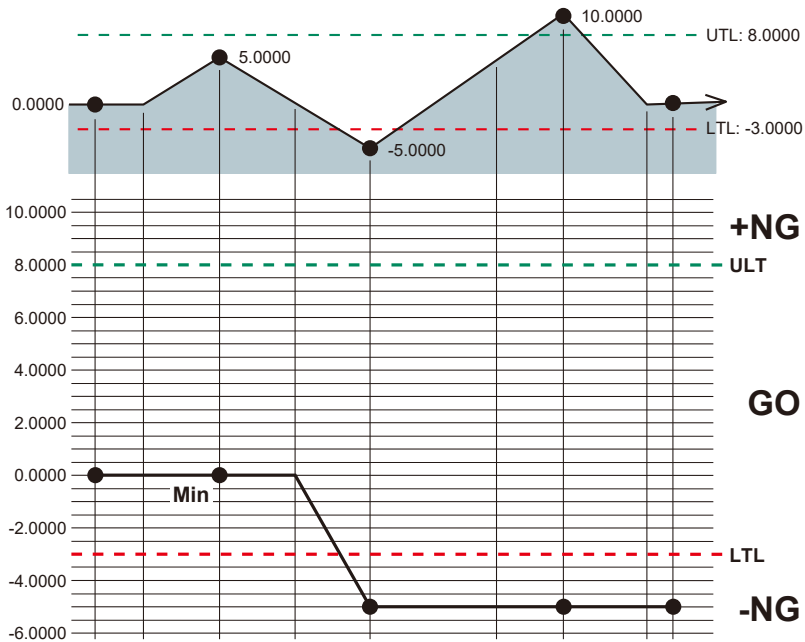

4.3 Tolerance Judgment

The upper/lower limit allowable values can be set to provide a GO/NG judgment for the measured value (pass/fail judgment).

- Tolerance values can be set for absolute measurement / incremental measurement (INC) respectively.
- Separate upper and lower limit values cannot be set for each peak value measurement (runout peak hold, maximum value peak hold, and minimum value peak hold).
- Tolerance judgment results are indicated on the display ([◀ ○ ▶]) and in the backlight (lit green when OK, lit red when NG).

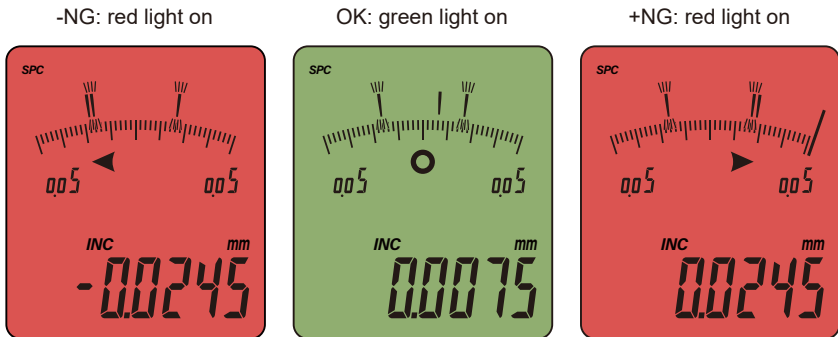

IMPORTANT

If the upper limit value < lower limit value is set, [Error90] is displayed. Short press the [SET/ZERO] key to clear the error and then re-set the upper limit value > lower limit value.

4.3.1 Tolerance Judgment Implementation

Turn ON tolerance judgment and set the upper and lower tolerance limits.

- 1 Short press the [MODE] key to until [◀ ○ ▶] display blinks.

Each time the key is short pressed, the mode changes.

(Normal Measurement → Tolerance Judgment

ON/OFF → Runout Width →

Maximum Value → Minimum Value →)

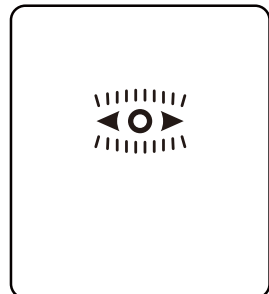

2 Turn ON tolerance judgment.

- 1 Short press the [SET/ZERO] key
 - » The [oFF] display starts blinking.
- 2 Short press the [MODE] key
 - » Switches to the [on] display flashing.

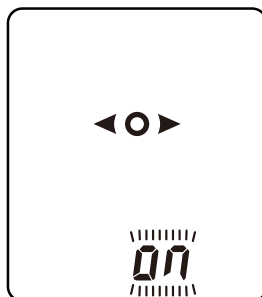
**3 Short press the [SET/ZERO] key to display the previously set upper limit value.**

(If not changing upper limit value proceed to step **5**)

- » The previously set upper limit value (e.g.: default value 0.0000 mm) is displayed and [▶] starts blinking.

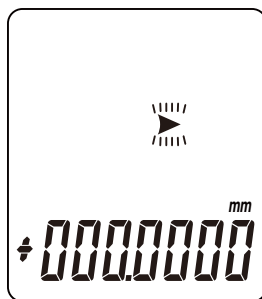
**4 Set the upper limit value.**

For details on setting the upper limit value, see "3.6 Display Value Preset" on page 18 (refer step **3**).

5 Short press the [SET/ZERO] key to confirm the upper limit value and display the previously set lower limit value.

(If not changing the lower limit value, proceed to step **7**)

- » The previously set lower limit value (e.g.: default value 0.0000 mm) is displayed and [◀] starts blinking.

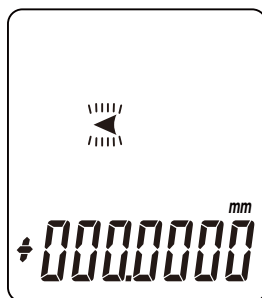
**6 Set the lower limit value.**

For details on setting the lower limit value, see "3.6 Display Value Preset" on page 18 (refer step **3**).

Tips

Long pressing the [MODE] key during tolerance setting returns to the state prior to the settings.

7 Short press the [SET/ZERO] key.

- » The lower limit value is determined and tolerance judgment begins.

**4.3.2 Cancelling Tolerance Judgment**

Tolerance judgment is turned OFF.

1 Short press the [MODE] key to until [◀○▶] display blinks.

Each time the key is short pressed, the mode changes.

(Normal Measurement → Tolerance Judgment ON/OFF → Runout Width → Maximum Value → Minimum Value →)

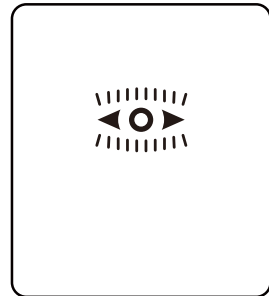
**2 Tolerance judgment is turned OFF.**

- 1 Short press the [SET/ZERO] key
 - » The [on] display starts blinking.
- 2 Short press the [MODE] key
 - » Switches to the [oFF] display flashing.

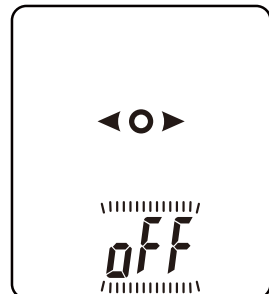
**3 Short press the [SET/ZERO] key.**

- » Cancel tolerance judgment.

4.4 Digimatic (SPC) Output of Displayed Values

Outputs the displayed value to a connected external device.

When connected to the optional Digimatic Mini Processor DP-1VA LOGGER, it is possible to collect, statistically process, and print measured values.

For details on connecting with external devices, refer to  "2.6 Connecting with External Devices" on page 14 and "8.1 I/O Format Switching" on page 47.

IMPORTANT

- When inputting an output request (REQ) from an external device, do so while the plunger is stopped. If an output request (REQ) is input during operation, wrong values may be output or data output itself may not be possible.
- If output requests (REQ) are input over short intervals, data output may not be possible.
- SPC (Digimatic) output can only output up to 6 digits. For example, if the 7-digit display value is [123.4565 mm], the output will be [23.4565 mm].
- When outputting data, please also carefully read the user's manual of the external device to be connected.

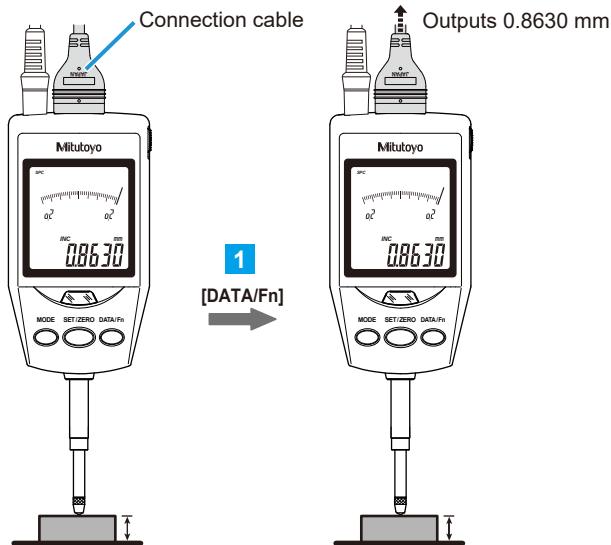

1 Short press the [DATA/Fn] key in measurement mode.

- » The displayed value is output to the connected external device.

MEMO

5 Setting Parameters

Change the setting parameters to switch between "measured value unit," "digital resolution," "counting direction," etc.

Tips

Parameter settings are retained even when the power is turned off. However, when all reset is performed, the settings are returned to the factory defaults.

5.1 List of Parameters

The parameters of this product include the following setting items.

LCD Display	In-text Notation	Setting details
unit	[unit]	Switches the unit of measurement. (ID-H0530E, ID-H0560E)
res.	[res.]	Switches the resolution on the LCD display.
range	[range]	Switches the analog range of the LCD display.
dir	[dir]	Switches counting direction.
output	[output]	Switches between I/O formats.
bps	[bps]	Switches the communication speed for RS-232 communication.
p.-bit	[p.-bit]	Switches parity bits for RS-232 communication.
d.-bit	[d.-bit]	Switches data bits for RS-232 communication.
id-00	[id]	Set the ID No. for RS-232 communication and remote controller.
start	[start]	Switches the length measurement system at startup.
reset	[reset]	Initializes setting parameters.

5.2 Changing Parameters

Select the parameter to be changed and change the setting details.

Tips

- To finish changing parameters, long press the [MODE] key.
- If changes are terminated during the process, the setting details before finalization will not be reflected.

5.2.1 Parameter Selection

1 Long press the [MODE] key during normal measurement or peak value measurement.

- » The [unit] display flashes and the setting parameters can be changed.

2 Short press the [MODE] key until the desired change parameter is displayed.

- » Each time the [MODE] key is short pressed, the parameters are switched.
[unit] → [res.] → [range] → [dir] → [output] → [id] → [start] → [reset] →

3 Short press the [SET/ZERO] key.

- » The current setting details of the selected parameter is displayed blinking.

Change the settings according to each of the procedures described in "5.2.2 Changing Setting Details."

5.2.2 Changing Setting Details

■ [unit]: Switches the unit (ID-H0530E, ID-H0560E)

1 Short press the [MODE] key to change the setting details.

- » Each time the [MODE] key is short pressed, the setting details are switched.
in ← → mm

2 Short press the [SET/ZERO] key.

- » The setting details are confirmed and shifts to the next parameter " ■ [res.]."

■ [res.]: Toggles the LCD display resolution

1 Short press the [MODE] key to change the setting details.

- » Each time the [MODE] key is short pressed, the setting details are switched.
mm unit: 0.0005 ← → 0.001
in unit: 0.00002 → 0.00005 → 0.0001 →

2 Short press the [SET/ZERO] key.

- » The setting details are confirmed and shifts to the next parameter " ■ [range]."

■ [range]: Toggles the analog range

Sets the display range of the analog bar.

1 Short press the [MODE] key to change the setting details.

- » Each time the [MODE] key is short pressed, the setting details are switched.

The setting details vary depending on the resolution setting.

0.0005 mm	±0.01	→	±0.02	→	±0.05	→	±0.1	→	±0.2	→	±40	→	±80	→
0.001 mm	±0.02	→	±0.04	→	±0.15	→	±0.2	→	±0.4	→	±40	→	±80	→
0.00002 in	±.0004	→	±.0008	→	±.002	→	±.004	→	±.008	→	±2	→	±4	→
0.00005 in	±.001	→	±.002	→	±.004	→	±.01	→	±.02	→	±2	→	±4	→
0.0001 in	±.002	→	±.004	→	±.01	→	±.02	→	±.04	→	±2	→	±4	→
RS-232	A01	→	A02	→	A05	→	A10	→	A20	→	AFS	→	AFL	→

2 Short press the [SET/ZERO] key.

- » The setting details are confirmed and shifts to the next parameter " ■ [dir]."

■ [dir]: Switches the counting direction

Sets the counting direction relative to the direction of plunger movement.

1 Short press the [MODE] key to change the setting details.

- » Each time the [MODE] key is short pressed, the setting details are switched.

Positive counting ← → Negative counting

Positive counting

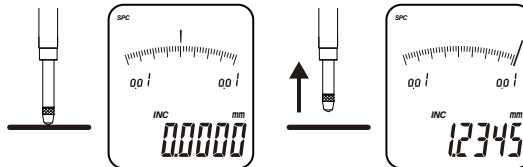

Negative counting

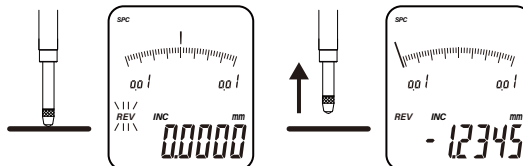

2 Short press the [SET/ZERO] key.

- » The setting details are confirmed and shifts to the next parameter "■ [output]."

■ [output]: Switches between I/O formats

Select I/O format from SPC (Digimatic) and RS-232 communication.

1 Short press the [MODE] key to change the setting details.

- » Each time the [MODE] key is short pressed, the setting details are switched.
SPC ← → RS-232

2 Short press the [SET/ZERO] key.

- » In the case of SPC selection, the setting details are confirmed and shifts to the next page "■ [reset]."
In case of RS-232 selection, the setting details are confirmed and shifts to the next "● [bps]."

● [bps]: Switches communication speed**1 Short press the [MODE] key to change the setting details.**

- » Each time the [MODE] key is short pressed, the setting details are switched.
4800 ← → 9600

2 Short press the [SET/ZERO] key.

- » The setting details are confirmed and shifts to the next parameter "● [p.-bit]."

● [p.-bit]: Switches parity bits**1 Short press the [MODE] key to change the setting details.**

- » Each time the [MODE] key is short pressed, the setting details are switched.
0 (none) → 1 (odd) → 2 (even) →

2 Short press the [SET/ZERO] key.

- » The setting details are confirmed and shifts to the next parameter "● [d.-bit]."

● [d.-bit]: Switches data bits**1 Short press the [MODE] key to change the setting details.**

- » Each time the [MODE] key is short pressed, the setting details are switched.
7 bit ← → 8 bit

2 Short press the [SET/ZERO] key.

- » The setting details are confirmed and shifts to the next parameter " ■ [id]".

■ [id]: Sets ID No. for RS-232 communication and remote controller

When an ID No. is set for this product, only signals from remote controller units with the same ID No. and RS-232 communication are received. However, if the ID No. on the remote controller and RS-232 communication side is set to [00], signals are received regardless of the ID No. of this product.

Tips

- The ID No. of the optional remote controller can be set from [00] to [07] and [09] to [15].
- The ID No. for RS-232 communication can be set from [00] to [99].

1 Short press the [MODE] key to change the setting details of digit 1.

- » Each time the [MODE] key is short pressed, the setting details are switched.
0 → 1 → 2 → 3 → 4 → 5 → 6 → 7 → 8 → 9 →

2 Short press the [SET/ZERO] key.

- » Digit 1 is confirmed and shifts to digit 10.

3 Short press the [MODE] key to change the setting details of digit 10.

- » Each time the [MODE] key is short pressed, the setting details are switched.
0 → 1 → 2 → 3 → 4 → 5 → 6 → 7 → 8 → 9 →

4 Short press the [SET/ZERO] key.

- » The setting details are confirmed and shifts to the next parameter " ■ [start]".

■ [start]: Switches the length measurement system at startup**1 Short press the [MODE] key to change the setting details.**

- » Each time the [MODE] key is short pressed, the setting details are switched.
INC ← → No display (Starts with the length measurement system as of the last stop timing)

2 Short press the [SET/ZERO] key.

- » The setting details are confirmed and shifts to the next parameter " ■ [reset]".

■ [reset]: Initializes setting parameters

IMPORTANT

- When the parameters are reset to their default settings, the preset values and upper and lower limit values are also cleared. Please set again.
- Do not initialize during RS-232 communication. RS-232 communication will be disabled because the "I/O format" and "ID No." will be changed.

1 Short press the [MODE] key to select yes (initialize).

Each time the [MODE] key is short pressed, the setting details are switched.
no ← → yes (initialize)

2 Short press the [SET/ZERO] key.

» All setting parameters are initialized and shifts to the next parameter "■ [unit]".

● Default settings for each parameter

Description display	Setting details	Default setting
[unit]	Measured Value Unit	mm
[res.]	LCD display resolution	0.0005
[range]	LCD display analog range	0.01
[dir]	Counting direction	Positive counting
[output]	Output format	SPC
[bps]	RS-232 communication speed	9600 bps
[p.-bit]	Parity bits for RS-232 communication	Even numbers
[d.-bit]	RS-232 communication data bits	7 bit
[id]	ID No. for RS-232 communication and remote controller	00
[start]	Length measurement system at startup	INC





6 Precautions after Use

- Dirt on the plunger may lead to malfunction. Clean with a cloth moistened with alcohol, etc. before use.
- Do not lubricate the plunger with lubricant or other oil.
- Lightly wipe off dirt on the exterior with a lint-free soft cloth (silicone cloth, etc.).
- If wiped with benzene, etc., or if metal polish is used, the surface may become discolored or the coating may peel off.
- Do not use organic solvents such as detergents, thinner or benzine.
- Do not store in a place with a high temperature or humidity, or a lot of dust or oil mist.



MEMO

7 Error Displays and Countermeasures

An error is displayed when an issue occurs in the product. (Error output is also provided during RS-232 communication. No error output is performed during SPC.) If the product does not return to normal condition after the countermeasures, please contact the agent where you purchased the product or a Mitutoyo sales/service representative.

LCD display (RS-232 output)	Cause	Countermeasures
 (Error20)	Overspeed <ul style="list-style-type: none"> The operating speed of the plunger exceeded the response speed of this product. 	<ul style="list-style-type: none"> Short press the [SET/ZERO] key to clear the error. Use the plunger at a speed that is within the response speed. If the [SET/ZERO] key is short pressed but the unit does not return to normal operation, the sensor may be malfunctioning. Refer to  "10 Off-Site Repairs (Subject to Charge)" on page 59 for handling details.
 (Error30)	Display Overflow <ul style="list-style-type: none"> The displayed value exceeded the number of digits that can be displayed. 	<ul style="list-style-type: none"> It is automatically resolved when the displayed value returns to the number of digits that can be displayed. Perform preset or zero setting. *1 Lower the resolution. *2
Normal measurement screen (Error52)	RS-232 command input error <ul style="list-style-type: none"> Command input is incorrect. 	<ul style="list-style-type: none"> Re-enter the correct command.
 (Error90)	Tolerance setting error <ul style="list-style-type: none"> The upper limit value is set to < the lower limit value. 	<ul style="list-style-type: none"> Short press the [SET/ZERO] key to reset so the upper limit value > lower limit value.

7 Error Displays and Countermeasures

LCD display (RS-232 output)	Cause	Countermeasures
 (Error95P)	Preset value setting error <ul style="list-style-type: none"> • Preset value overflows. 	<ul style="list-style-type: none"> • Set the preset value again. *3 • Lower the resolution. *3
 (Error95G)	Upper Limit Setting Error <ul style="list-style-type: none"> • The upper limit value is overflowing. 	<ul style="list-style-type: none"> • Reset the upper limit value. *4 • Lower the resolution. *3
 (Error95D)	Lower Limit Setting Error <ul style="list-style-type: none"> • The lower limit value is overflowing. 	<ul style="list-style-type: none"> • Reset the lower limit value. *4 • Lower the resolution. *3

*1: Short press the [SET/ZERO] key to implement the preset.

For details, refer to  "3.6 Display Value Preset" on page 18.

Long press the [SET/ZERO] key to switch to incremental measurement (INC).

For details, refer to  "3.3 Switching Measurement Systems" on page 16.

*2: Long press the [MODE] key to change the setting parameters.

For details, refer to  "5.2 Changing Parameters" on page 38.

*3: Short press the [MODE] key ([Error30] is displayed) to release via the method described in *1 or *2.

*4: Long press the [MODE] key ([◀ ○ ▶] flashes) to reset the upper and lower limit values.

For details, refer to  "4.3 Tolerance Judgment" on page 32.

Tips

- If I/O is not possible, the communication settings may be incorrect. Check the settings of this product and connected devices.
- Refer to  "8.3 RS-232 Communication I/O Specifications" on page 50 for details on RS-232 output commands.
- If the above error occurs during function lock, press the [DATA/Fn] key for at least 2 seconds to release the function lock, and then perform the error release process.

8 Data I/O

This product is capable of data I/O via Digimatic or RS-232 communication.

Refer to  "2.6 Connecting with External Devices" on page 14 for details on connecting with external devices.

Tips

When outputting data, read the user's manual of the external device to be connected carefully follow the instructions.

8.1 I/O Format Switching

Switches parameter I/O format settings (SPC / RS-232) to match the connected external device.

For details, refer to  "  [output]: Switches between I/O formats" on page 40.

8.2 SPC (Digimatic) I/O Specifications

8.2.1 I/O Connector

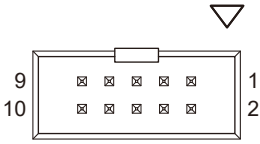

Pin No.	Signal	I/O	Pin No.	Signal	I/O
1	GND	-	6	(N.C.)	-
2 (*1)	DATA1	O	7	(N.C.)	-
3 (*1)	\overline{CK}	O	8	VDD (5 V)	O
4 (*1)	\overline{RD}	O	9	(N.C.)	-
5 (*2)	\overline{REQ}	I	10	GND	-

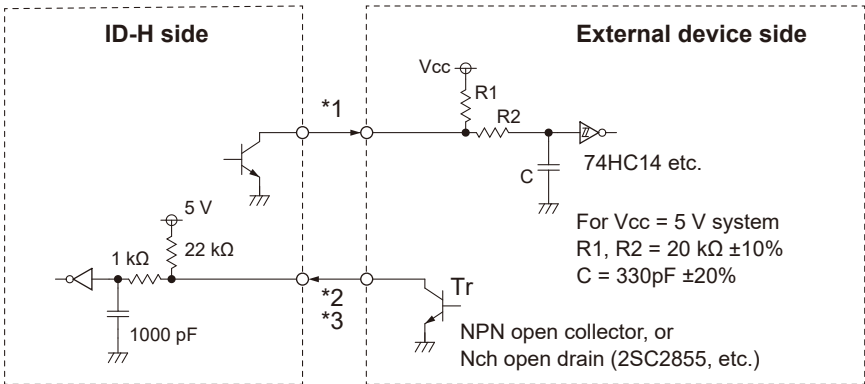

IMPORTANT

- Since the power supply voltage differs between this product and the external device side, always use the open collector output or open drain output on the external device side. Do not use CMOS output, etc.
- Pin number 8 is a dedicated pin for RS-232 communication. Power cannot be supplied from or to external devices.

8.2.2 Output Data Format (DATA1)

Digimatic outputs the display value data to an external device in response to the REQ signal.

IMPORTANT

SPC (Digimatic) output can only output up to 6 digits. For example, if the 7-digit display value is [123.4565 mm], the output will be [23.4565 mm].

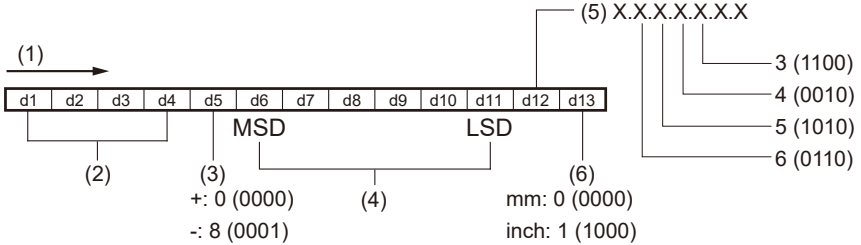

- (1) Output Order
Each digit: d1 → d13
Each bit within digit 1: bit0 → bit3
- (2) All "F (1111)"
- (3) Sign
- (4) Measured value (6 digits)
- (5) Decimal point position
- (6) Unit

8.2.3 Timing Chart

IMPORTANT

If an output request (REQ) is received while the plunger is operating, or if a continuous output request (REQ) with a short interval is received, data output may not be possible.

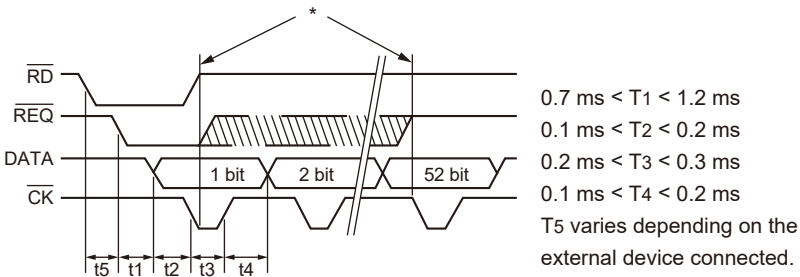

- * Keep REQ at Low until CK is output.
Return it to High before the final CK output is completed (52nd bit).

8.3 RS-232 Communication I/O Specifications

Using the optional RS-232 connection cable, this product can be connected to an external device such as a PC to perform default settings using communication commands, execute controls such as mode switching during measurement, or transfer measured values.

Multiple units of this product can be controlled from a single port of an external device by using this product's ID No. setting function.

For details, refer to  " ■ [id]: Sets ID No. for RS-232 communication and remote controller" on page 41.

8.3.1 I/O Connector

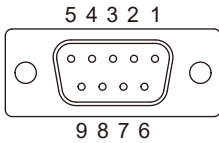

Connector Specifications:
D-sub 9Pin female
(Receptacle)
Inch screw
specifications

Pin No.	Signal	I/O	Details
1	(N.C.)	-	-
2	TxD	O	Sent Data
3	RxD	I	Received Data
4	DSR	I	Data Set Ready
5	S.G	-	Ground
6	DTR	O	Data Terminal Ready
7	CTS	I	Transmittable
8	RTS	O	Request-To-Send
9	(N.C.)	-	-

* Pin assignments are for RS-232 connection cable connectors.

8.3.2 Communication Specifications

Item	Specifications
Home Position	DCE (modem defined), using RS-232 connection cable
Compliance Standards	EIA/TIA-232F (RS-232)
Communication System	Half Duplex
Communication speed (bit rate)	4800 bps, 9600 bps
Data length	7 bit, 8 bit / ASCII / Upper case
Parity Control	None, even, odd
Stop Bit	2 bit
Control Signal	No CTS or DSR control

Refer to  " ■ [output]: Switches between I/O formats" on page 40 for details on how to switch communication speed, data bits, and parity bits.

8.3.3 Communication Commands (I/O Format)

Refer to  "4 Measurement Method" on page 23 for the meaning of each item in the operation details.

● Measurement commands

Operation Details		Input (External device → this product)	Output (This product → external device)
Measurement system	Zero setting (Switch to INC system)	CR**CRLF	CH**CRLF
	Switch to preset system	DS**,PCRLF	DH**,PRESETCRLF (Refer to Tips) DH**CRLF
	Preset Value Setting	CP**,+0016.2345CRLF	CH**CRLF
	Preset Value Output	DP**,OUTCRLF	DH**,+0016.2345CRLF
Measurement Mode Switching	Normal	CN**CRLF	CH**CRLF
	Maximum Value	CX**CRLF	
	Minimum Value	CM**CRLF	
	Runout Width	CW**CRLF	
Data output	Normal	GA**CRLF	GN**,+0016.2345CRLF
	Maximum Value		GX**,+0016.2345CRLF
	Minimum Value		GM**, -0016.2345CRLF
	Runout Width		GW**,+0016.2345CRLF
Peak Hold	Hold Release (Start of measurement)	CL**CRLF	CH**CRLF
	Peak Zero Setting	DS**,XM-ZEROCRLF	DH**CRLF
Tolerance Judgment	Judgment ON	DJ**,ONCRLF	DH**CRLF
	Judgment OFF	DJ**,OFFCRLF	
	Upper Limit Value Input	CG**,+0016.2345CRLF	CH**CRLF
	Lower Limit Value Input	CD**, -0016.2345CRLF	
	Upper Limit Value Output	DJ**,GOUTCRLF	DG**,+0016.2345CRLF
	Lower Limit Value Output	DJ**,DOUTCRLF	DD**, -0016.2345CRLF
	Judgment Output (OK)	DJ**,OUTCRLF	DH**,OKCRLF
	Judgment Output (+NG)		DH**,+NGCRLF
	Judgment Output (-NG)		DH**, -NGCRLF
Judgment Output (Judgment OFF)	DH**,JOFFCRLF		
Analog Display	Pointer Centering	DA**CRLF	DH**CRLF
Function Lock	Lock	DF**,LOCKCRLF	DH**CRLF
	Release	DF**,FREECRLF	
	Status Output (Locked)	DF**,OUTCRLF	DH**,F-LOCKCRLF
	Status Output (Releasing)		DH**,F-FREECRLF

Tips

- "CRLF" indicates "CR (carriage return)" and "LF (line feed)".
- "***" Indicates the ID No.
For details, refer to  " ■ [id]: Sets ID No. for RS-232 communication and remote controller" on page 41.
- Set the ID No. between [00] and [99].
- For ID No. [01] to [99], only the product with the specified ID No. will receive / execute the command.
- For ID No. [00], commands are received / executed regardless of the ID No. setting of this product.
- When shifting to the preset system for the first time after power supply ON, this product returns the command "DH**,PRESETCRLF" because the preset value has not been determined. Continue to input the preset values.
- In incremental measurement (INC), the preset value setting forces a shift to absolute measurement.
- Each peak hold mode is released when the INC system is shifted to the preset system.
- Preset and tolerance value settings should be specified as a 10-digit number sequence, including sign and decimal point. However, the number following the sign is fixed at "0". The same number sequence is also used for output of displayed and set values.
- For preset and tolerance value settings, input the numerical value and decimal point position according to the resolution.
- The newly set tolerance value is compared with the currently set tolerance value to make an "Error90" judgment.
- After receiving the response output to the command, send the next command. If there is no response to the command, clear the communication buffer and send the command again after at least 1 second has elapsed.
- This product performs key operations with the highest priority. During key operation, the RS-232 communication function is temporarily stopped, and when the unit returns to a countable state, commands and data output are executed.

● Parameter configuration command



Refer to  "4 Measurement Method" on page 23 for the meaning of each item in the operation details.

IMPORTANT

In "Initialize Settings" by RS-232 input, "I/O Format" and "ID No." settings are retained.

Operation Details		Input (External device → this product)	Output (This product → external device)
Switching unit	mm	DJ**,MMCRLF	DH**CRLF
	inch	DJ**,INCRLF	
	Status output (mm)	DJ**,OUTCRLF	DH**,MMCRLF
	Status output (inch)		DH**,INCRLF
Resolution Switching	0.0005 mm	DR**,D0.000500CRLF	DH**CRLF
	0.001 mm	DR**,D0.001000CRLF	
	0.00002 in	DR**,D0.000020CRLF	
	0.00005 in	DR**,D0.000050CRLF	
	0.0001 in	DR**,D0.000100CRLF	
	Status Output	DR**,DOUTCRLF	DH**,D0.000500CRLF
Analog Range Switching	Range Setting	DR**,A##CRLF	DH**CRLF
	Status Output	DR**,AOUTCRLF	DH**,A##CRLF
Counting Direction Switching	+ Direction	DD**,NORMCRLF	DH**CRLF
	- Direction	DD**,REVCRLF	
	Status Output (+)	DD**,OUTCRLF	DH**,NORMCRLF
	Status output (-)		DH**,REVCRLF
Length measurement system at startup	Always INC system	DS**,SINCRLF	DH**CRLF
	Length measurement system at stop	DS**,SFREECRLF	
Current length measurement system / Length measurement system at startup	INC system / INC startup	DS**,OUTCRLF	DH**,INC-SINCRLF
	INC system / Startup at stop		DH**,INC-SFREECRLF
	P system/INC startup		DH**,P-SINCRLF
	P system / Startup at stop		DH**,P-SFREECRLF
Settings Initialization		DE**,RESETCRLF	DH**CRLF

Tips

"A##" indicates analog range setting commands. Refer to  "  [range]: Toggles the analog range" on page 39 for a table of analog range and command correspondence.

● Error command

Refer to  "7 Error Displays and Countermeasures" on page 45 for details on each error.

Operation Details		Input (External device → this product)	Output (This product → external device)
Error	Overspeed	-	CH**,Error_20CRLF
	Overflow		CH**,Error_30CRLF
	Communication Command Issues		CH**,Error_52CRLF
	Tolerance setting error		CH**,Error_90CRLF
	Preset Value Issues		CH**,Error_95PCRLF
	Upper Limit Value Issues		CH**,Error_95GCRLF
	Lower Limit Value Issues		CH**,Error_95DCRLF
	Release	CS**CRLF	CH**CRLF

Tips

"_" indicates a space.

9 Specifications

9.1 Specifications

■ Model specific specifications

Model No.		ID-H0530	ID-H0560	ID-H0530E	ID-H0560E	
Code No. ^{*1}		543-561	543-563	543-562	543-564	
Measuring range		30.48 mm	60.96 mm	30.48 mm / 1.2 in	60.96 mm / 2.4 in	
Resolution		0.0005 mm		0.0005 mm / 0.00002 in		
Resolution switching		0.0005 / 0.001 mm		0.0005 mm / 0.001 mm 0.00002 in / 0.00005 in / 0.0001 in		
JIS/ISO	Error of indication (MPE)	Partial measuring range P_{MPE}^{*2}	0.0015 mm	0.0025 mm	0.0015 mm	0.0025 mm
		Total measuring range E_{MPE}^{*2}	0.0015 mm	0.0025 mm	0.0015 mm	0.0025 mm
	Hysteresis H_{MPE}^{*2}		0.0015 mm	0.0025 mm	0.0015 mm	0.0025 mm
	Repeatability R_{MPE}^{*2}		0.001 mm		0.001 mm	
ASME	Overall ^{*2,3}		-	-	±0.00006 in	±0.0001 in
	Hysteresis ^{*2}		-	-	0.00006 in	0.0001 in
	Repeatability ^{*2}		-	-	0.00004 in	
Stem		ø8 mm		ø9.52 mm / 0.375 in DIA		
Contact point		Carbide SR1.5 (M2.5 x 0.45) Part No. 901312 (standard accessory)		Carbide SR1.5 (No. 4-48UNF) Part No. 21BZB005 (Standard accessory)		
Measuring force (MPL)		2.0 N or less	2.5 N or less	2.0 N or less	2.5 N or less	
Measurement direction		Below horizontal				
Mass		Approx. 290 g (0.63 lbs)	Approx. 305 g (0.67 lbs)	Approx. 290 g (0.63 lbs)	Approx. 305 g (0.67 lbs)	

9 Specifications

■ Common specifications

Protection level *4	IP30 equivalent *5
CE Marking / UKCA Marking	EMC Directive / Electromagnetic Compatibility Regulation: EN IEC 61326-1 Immunity test requirement: Clause 6.2 table 2 Emission limit: Class B RoHS Directive / Regulation Restricting Use of Specified Hazardous Substances in Electric / Electronic Devices: EN IEC 63000
Power supply	External power supply (AC adapter 5.9 V 2 A)
Current Consumption	200 mA or less
Scale	Photoelectric linear encoder
Response speed	1000 mm/s
Data output	Digimatic, RS-232
Temperature range	Operating temperature range: 0 °C to 40 °C Storage temperature range: -10 °C to 60 °C

*1: The code No. suffix varies depending on the included AC adapter.

*2: During normal measurement at 20 °C

*3: Overall magnification and linearity

*4: The protection level (IP: International Protection) is based on IEC 60529/
JIS C 0920.

*5: Values are for factory conditions.

9.2 Standard Accessories

- AC adapter (100 V to 240 V: Japan, USA, Canada, & Co.): Part No. 06AGZ369JA
- AC adapter (100 V to 240 V: Germany, & Co.): Part No. 06AGZ369D
- AC adapter (100 V to 240 V: UK, & Co.): Part No. 06AGZ369E
- AC adapter (100 V to 240 V: Korea, for KC): Part No. 06AGZ369K
- AC adapter (100 V to 240 V: China, for CCC): Part No. 06AGZ369DC
- Clamp filter (ferrite core): Part No. 21EAA150
- Lifting lever (finger hook): Part No. 21EAA426
- Quick Start Guide: Part No. 99MAH065M
- Safety Precautions (including warranty): Part No. 99MAH066M
- Certificate of Inspection

9.3 Accessories (Optional)

- Remote controller: Part No. 21EZA099
- Lifting knob: Part No. 21EZA101
- Release: Part No. 21JZA295
- Back with lug (ISO/JIS): Part No. 101040
- Back with lug (ANSI/AGD): Part No. 101306
- Connection cable: Part No. 936937 (1 m)
- Connection cable: Part No. 965014 (2 m)
- RS-232 Connection Cable: Part No. 21EAA131 (2 m)

*For accessories (optional) other than the above, refer to the Measuring Instruments Catalog.

MEMO

10 Off-Site Repairs (Subject to Charge)

Off-site repair (subject to charge) is required in the case of the following malfunctions. Please contact the agent where you purchased the product or a Mitutoyo sales/service representative.

- Poor plunger operation
- Poor accuracy
- When the plunger is stationary, [Error20] is displayed
- Abnormal measured value or LCD trouble
- Power will not turn on

*If the fundamental structural components or multiple components need to be replaced, we reserve the right to decline the repair.

MEMO

SERVICE NETWORK

Please refer to the URL below.

<https://www.mitutoyo.co.jp/eng/corporate/network/overseas/index.html>

Mitutoyo Corporation

20-1, Sakado 1-Chome, Takatsu-ku, Kawasaki-shi, Kanagawa 213-8533, Japan
Tel: +81 (0)44 813-8230 Fax: +81 (0)44 813-8231
Home page: <https://www.mitutoyo.co.jp/global.html>

For the EU Directive, Authorized representative and importer in the EU:
Mitutoyo Europe GmbH
Borsigstrasse 8-10, 41469 Neuss, Germany

For the UK Regulation, Authorized representative and importer in the UK:
Mitutoyo (UK) Ltd.
Joule Road, West Point Business Park, Andover, Hampshire SP10 3UX,
UNITED KINGDOM