

ABSOLUTE Digimatic Indicator ID-C

ID-C0512NX

ID-C0512MNX

ID-C0512ENX

ID-C0512CNX

ID-C0512CMNX

ID-C0512CENX

ID-C1012NX

ID-C1012MNX

ID-C1012ENX

ID-C1012CNX

ID-C1012CMNX

ID-C1012CENX

ID-C0512NXB

ID-C0512MNXB

ID-C0512ENXB

ID-C0512CNXB

ID-C0512CMNXB

ID-C0512CENXB

ID-C1012NXB

ID-C1012MNXB

ID-C1012ENXB

ID-C1012CNXB

ID-C1012CMNXB

ID-C1012CENXB

User's Manual

■ Product names and model numbers covered in this document

Product name	Model number	
ABSOLUTE Digimatic Indicator ID-C	ID-C0512NX	ID-C0512NXB
	ID-C0512MNX	ID-C0512MNXB
	ID-C0512ENX	ID-C0512ENXB
	ID-C0512CNX	ID-C0512CNXB
	ID-C0512CMNX	ID-C0512CMNXB
	ID-C0512CENX	ID-C0512CENXB
	ID-C1012NX	ID-C1012NXB
	ID-C1012MNX	ID-C1012MNXB
	ID-C1012ENX	ID-C1012ENXB
	ID-C1012CNX	ID-C1012CNXB
	ID-C1012CMNX	ID-C1012CMNXB
	ID-C1012CENX	ID-C1012CENXB





■ Notice regarding this document

- The contents of this document are based on information current as of June 2023.
- No part or whole of this document may be transmitted or reproduced by any means without prior written permission of Mitutoyo Corporation.
- Some screen displays in this document may be highlighted, simplified or partially omitted for convenience of explanation. In addition, some of them may differ from actual ones to the extent that no user will misunderstand the functions and operations.
- The corporation, organization and product names that appear in this document are their trademarks or registered trademarks.

©2021-2023 Mitutoyo Corporation. All rights reserved.

CONVENTIONS AND WORDING USED IN THIS MANUAL

■ Safety reminder conventions and wording warning against potential hazards

 DANGER	Indicates a hazard with a high level of risk which, if not avoided, will result in death or serious injury.
 WARNING	Indicates a hazard with a medium level of risk which, if not avoided, could result in death or serious injury.
 CAUTION	Indicates a hazard with a low level of risk which, if not avoided, could result in minor or moderate injury.
NOTICE	Indicates a potentially hazardous situation which, if not avoided, may result in property damage.
	Flammable material Alerts the user to a specific hazardous situation that means "Caution, risk of igniting gas".

■ Conventions indicating prohibited and mandatory actions

 Indicates concrete information about prohibited actions.	 Indicates concrete information about mandatory actions.
--	---

■ Conventions and wording indicating referential information or reference location

Tips Indicates further information and details relevant for the operating methods and procedures that are explained in that section.



Indicates reference location if there is information that should be referred to in this document or an extraneous User's Manual.

E.g.: For details about XX, see  "1.2 Names and Dimensions of Components" on page 2.

Safety Precautions

Read these "Safety Precautions" thoroughly before operating the product to use it properly.

These safety precautions include such information as to prevent injury to the operator and other persons, damage to property and product defects. Be sure to observe these precautions carefully.

DANGER



Do not use the product in areas where volatile gases may be generated. There is a risk of igniting the gas.

WARNING

- The product is not to be repaired or modified by the users.
- If the product is dropped or otherwise damaged, turn the power OFF and remove the battery, and then contact the agent where you purchased the product or a Mitutoyo sales/service representative.
- Be sure to use the product specified in this document when an optional item is required.

■ Handling batteries

This product uses a lithium metal battery (CR2032). Observe the following precautions in use.

WARNING

- Always keep batteries out of reach of children. If swallowed, consult a physician immediately.
- Batteries should never be short-circuited, disassembled, deformed or come in contact with extreme heat or flames.
- If alkaline liquid from the battery comes in contact with the eyes, flush eyes immediately with clean water and consult a physician. If alkaline liquid from battery comes in contact with the skin, flush the exposed area thoroughly with clean water.

CAUTION

Never attempt to charge the primary battery. Never reverse the positive-negative terminals when mounting. Improper battery handling or mounting may cause the battery to explode, cause battery leakage and/or serious bodily injury or malfunctioning.

Precautions for Use

■ Product applications and handling

- Do not apply excessive force or subject to sudden impacts such as when dropped.
- Do not write with an electric pen, etc. This may cause damage.
- Do not operate the keys with a pointed object (such as a screwdriver or ballpoint pen).
- Avoid loads in the direction perpendicular to the plunger movement or usage resulting in torsion of the plunger.

■ Usage environment

- Avoid using or storing in places directly exposed to sunlight, or extremely hot or cold places.
- Use or storage in places with low or high atmospheric pressure may cause material deterioration, etc., leading to failure.
- Do not store the product in a place with high humidity. Also, avoid usage in places exposed to splashes of water or coolant.
- The product may malfunction if used in areas with high electrical noise.
- Securely fix to an optional stand of dial indicator, etc., and use in a place where there is no vibration.
- Errors will result when used in places with significant temperature fluctuation, due to the thermal expansion of structural components and fixing jigs. Use in places with minimal temperature fluctuation. Allow the product to adapt to the ambient temperature when using in a location with a different temperature.

■ Maintenance

- Lightly wipe off dirt on this product with a lint-free soft cloth. Do not use organic solvents such as detergents, thinner or benzine.
- Dirt on the plunger may lead to malfunction. Clean with a cloth moistened with alcohol, etc. before use.
- Do not lubricate the plunger with lubricating oil, etc.

Electromagnetic Compatibility (EMC)

This product complies with the EMC Directive and the UK Electromagnetic Compatibility Regulations; however, if this receives electromagnetic interference that exceeds these requirements, it will be out of warranty and require appropriate measures.

Warranty

This product has been manufactured under strict quality management, but should it develop problems within one year of the date of purchase in normal use, repair shall be performed free of charge. Please contact the agent where you purchased the product or a Mitutoyo sales/service representative (☰ "SERVICE NETWORK" on page App-1). This warranty, however, shall not affect any provisions of the Mitutoyo Software End User License Agreement.

If this product fails or is damaged for any of the following reasons, it will be subject to a repair charge, even if it is still under warranty.

- Failure or damage owing to fair wear and tear
- Failure or damage owing to inappropriate handling, maintenance or repair, or to unauthorized modification
- Failure or damage owing to transport, dropping, or relocation of the product after purchase
- Failure or damage owing to fire, salt, gas, abnormal voltage, lightning surge, or natural disaster
- Failure or damage owing to use in combination with hardware or software other than those designated or permitted by Mitutoyo
- Failure or damage owing to use in ultra-hazardous activities

This warranty is effective only where the product is properly installed and operated in conformance with the instructions in this document within the original country of the installation.

EXCEPT AS SPECIFIED IN THIS WARRANTY, ALL EXPRESS OR IMPLIED CONDITIONS, REPRESENTATIONS, AND WARRANTIES OF ANY NATURE WHATSOEVER INCLUDING, WITHOUT LIMITATION, ANY IMPLIED WARRANTY OF MERCHANTABILITY, FITNESS FOR A PARTICULAR PURPOSE, NONINFRINGEMENT OR WARRANTY ARISING FROM A COURSE OF DEALING, USAGE, OR TRADE PRACTICE, ARE HEREBY EXCLUDED TO THE MAXIMUM EXTENT ALLOWED BY APPLICABLE LAW.

You assume responsibility for all results due to the selection of this product to achieve your intended results.

Disclaimer

IN NO EVENT WILL MITUTOYO, ITS AFFILIATED AND RELATED COMPANIES AND SUPPLIERS BE LIABLE FOR ANY LOST REVENUE, PROFIT, OR DATA, OR FOR SPECIAL, DIRECT, INDIRECT, CONSEQUENTIAL, INCIDENTAL, OR PUNITIVE DAMAGES HOWEVER CAUSED AND REGARDLESS OF THE THEORY OF LIABILITY ARISING OUT OF THE USE OF OR INABILITY TO USE THIS PRODUCT EVEN IF MITUTOYO OR ITS AFFILIATED AND RELATED COMPANIES AND/OR SUPPLIERS HAVE BEEN ADVISED OF THE POSSIBILITY OF SUCH DAMAGES.

If, notwithstanding the foregoing, Mitutoyo is found to be liable to you for any damage or loss which arises out of or is in any way connected with use of this product by you, in no event shall Mitutoyo's and/or its affiliated and related companies' and suppliers' liability to you, whether in contract, tort (including negligence), or otherwise, exceed the price paid by you for the product only.

The foregoing limitations shall apply even if the above-stated warranty fails of its essential purpose.

BECAUSE SOME COUNTRIES, STATES OR JURISDICTIONS DO NOT ALLOW THE EXCLUSION OR THE LIMITATION OF LIABILITY FOR CONSEQUENTIAL OR INCIDENTAL DAMAGES, IN SUCH COUNTRIES, STATES OR JURISDICTIONS, MITUTOYO'S LIABILITY SHALL BE LIMITED TO THE EXTENT PERMITTED BY LAW.

About This Document

This document is intended to provide an overview of the product, the functions of each component, setup, usage and maintenance details.

■ How to read this document

5 Setting Parameters ➡ (Short press) / ⇨ (Long press)

1 Press the [F2] key.

- » Calculation function can be set.

2 Setting the execution/stop of the calculation function

- 1 Press the [F1] key or [F3] key.
 - » Each time the key is pressed, it will switch execution/stop.
- 2 Press the [F2] key.

When execution [on] is selected:

 - » The calculation function display (A) blinks and the previously set calculation coefficient is displayed.

Tips

If the displayed calculation coefficient is correct, press the [F2] key. Calculation coefficient is confirmed; shifts to the next parameter item.

When stop [oFF] is selected:

 - » Selection is confirmed; shifts to the next parameter item.
(Go to "5.8 Selecting Analog Bar Display" on page 56.)

3 Setting the calculation coefficient

- 1 Press and hold the [F2] key.
 - » The sign will blink and can be changed.
 - » Continue to 3 if not changing the sign.
- 2 Press the [F1] key or [F3] key.
 - » Each time the key is pressed, it will switch the sign.
- 3 Press the [F2] key.
 - » The sign is confirmed and the neighboring digit blinks.
- 4 Press the [F1] key or [F3] key.
 - » Each time the key is pressed, the value will change by one.
- 5 Press the [F2] key.
 - » The number is confirmed and the neighboring digit blinks.
 - » Each time the key is pressed, the blinking digit moves to the right.

Repeat steps 4 to 5 above until the numbers for all digits are confirmed (e.g.: -6.4641).

- » Confirming the last digit will cause the calculation function display (A) to blink.

6 Reconfirm the numerical value set and press the [F2] key.

- » Calculation coefficient is confirmed; shifts to the next parameter item.
(Go to "5.8 Selecting Analog Bar Display" on page 56.)

53 No. 99MAH056A

Indicates an operating procedure to be performed or its outline.

Indicates specific work procedures.

Indicates supplementary information.

Indicates the reference location.

■ Brackets, quotation marks and numbers (1, 1)



The meanings of brackets, quotation marks and numbers to be used in this document are as follows.

(): Round brackets	Represent a paraphrase of an immediately preceding phrase or a supplementary explanation.
" ": Double quotation marks	Represent a highlighted phrase. They also indicate an index where information to be referenced is described.
[]: Square brackets	Represent an item (menu, dialog, button, tab, etc.) that appears on the screen, or key on the controller or keyboard. They also indicate an item to be purposely entered or selected by the customer.
1, 2, 3... 1, 2, 3...	Indicates the order and the contents of tasks. (1: indicates main tasks, 1: indicates detailed tasks)

■ Key notations

In this manual, the names of the keys to be pressed, their operations (length and number of times the key is pressed), and the progress directions of procedures are indicated by arrows.

E.g.: [F2] key

	Press the [F2] key and release it immediately (short press).
	Press the [F2] key and release it after 2 seconds or longer (long press).

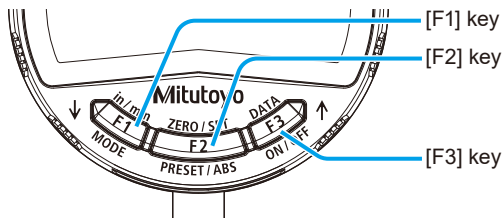

Contents

CONVENTIONS AND WORDING USED IN THIS MANUAL	i
Safety Precautions	ii
Precautions for Use	iii
Electromagnetic Compatibility (EMC)	iv
Warranty	iv
Disclaimer	v
About This Document	vi
Contents	viii
1 Overview	1
1.1 Overview of This Product.....	1
1.2 Names and Dimensions of Components	2
1.2.1 Main Unit	2
1.2.2 Display (LCD)	4
1.2.3 Standard Accessories	6
2 Preparations before Use	7
2.1 Mounting to a Stand/Jig	7
2.2 Mounting Options (Lifting Lever/Lifting Knob/Release)	8
2.2.1 Lifting Lever (Optional)	8
2.2.2 Lifting Knob (Optional)	9
2.2.3 Release (Optional)	10
2.3 Contact Point Replacement.....	11
2.4 Display Angle Adjustment	12
3 Basic Usage	13
3.1 Precautions before Use	13
3.2 Installing and Replacing the Battery	13
3.3 Power ON/OFF	16

3.4	Measurement Mode and Parameter Setting Mode	17
3.4.1	Measurement Mode	17
3.4.2	Parameter Setting Mode	17
3.5	Switching Measurement Systems	18
3.6	Switching Unit System	19
4	Measurement Method	21
4.1	Absolute Measurement (ABS).....	21
4.1.1	Setting Origin and Preset Values.....	22
4.1.2	Measurement Operations	24
4.2	Incremental Measurement (INC)	25
4.3	Peak Detection	26
4.4	Tolerance Judgment	29
4.5	Display Value Hold	30
4.6	Customizing Keys	31
4.7	Externally Outputting the Displayed Value	32
4.7.1	Connecting with External Devices	32
4.7.2	External Output Operation	33
5	Setting Parameters	35
5.1	Selecting Parameter Items	35
5.2	Selecting Measurement Mode	40
5.3	Selecting Unit System	41
5.4	Selecting Counting Direction	42
5.5	Selecting Resolution	44
5.6	Selecting the Tolerance Judgment Result Display Method and Setting Allowable Values	46
5.6.1	Setting Display Method	46
5.6.2	Setting Allowable Values (Upper Limit Value and Lower Limit Value)	48
5.7	Setting Calculation Function Selection and Calculation Coefficient ...	50
5.8	Selecting Analog Bar Display	56
5.9	Selecting Switch Function	60
5.10	Setting Function Lock	64

5.11	Change Other Functions	65
5.11.1	Selecting Setting Items	65
5.11.2	Calibration Schedule Warning Selection/Setting	66
5.11.3	Selecting Digimatic Output	71
5.11.4	Auto OFF setting	72
5.11.5	All Reset	73
6	Precautions after Use	75
7	Low Measuring Force Types	77
7.1	Changing the Measuring Force	77
7.1.1	Adding/Removing the Coil Spring	79
7.1.2	Adding/Removing the Weight	80
7.2	Contact Point Replacement.....	81
8	Error Displays and Countermeasures	83
9	Input/Output Functions	89
9.1	I/O Connector.....	89
9.2	DIGIMATIC d1/d2 (Output)	90
10	Specifications	93
11	Accessories (Optional)	103
12	Off-Site Repairs (Subject to Charge)	105
SERVICE NETWORK		App-1

1 Overview

1.1 Overview of This Product

This product is a Digimatic indicator that digitally displays the amount of plunger displacement. It is available in two types: the standard type and the low measuring force type.

It has the following features.

- It is equipped with a display function for tolerance judgment results. (☞ "4.4 Tolerance Judgment" on page 29)
- It can hold the peak values of the displaced measured values (runout, maximum value, minimum value). (☞ "4.3 Peak Detection" on page 26)
- It provides an analog bar display that makes it easy to check the approach to the origin and tolerance values. (☞ "1.2.2 Display (LCD)" on page 4)
- Depending on how this product is used, it is possible to customize the functions assigned to short-pressing of each key ([F1] key, [F2] key, [F3] key). (☞ "4.6 Customizing Keys" on page 31)
- Various settings can be made externally using the serial communication function. (☞ "9 Input/Output Functions" on page 89)

1.2 Names and Dimensions of Components

1.2.1 Main Unit

■ ISO/JIS models

Back with lug type:

ID-C0512NX, ID-C0512MNX, ID-C0512CNX, ID-C0512CMNX,
ID-C1012NX, ID-C1012MNX, ID-C1012CNX, ID-C1012CMNX

Flat back type*:

ID-C0512NXB, ID-C0512MNXB, ID-C0512CNXB, ID-C0512CMNXB,
ID-C1012NXB, ID-C1012MNXB, ID-C1012CNXB, ID-C1012CMNXB

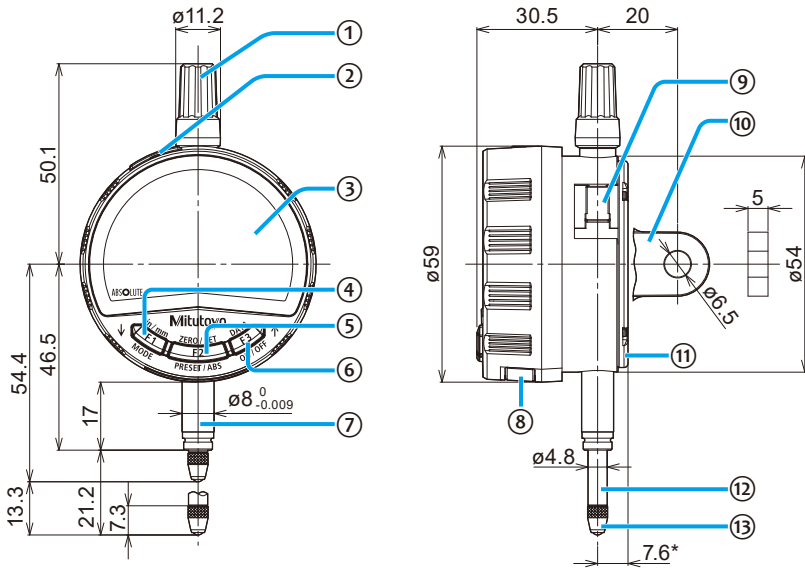

Unit: mm

①	Cap	⑤	[F2] key
②	I/O connector (with cover)	⑥	[F3] key
③	Display (LCD)	⑦	Stem
④	[F1] key	⑧	Battery holder

1 Overview

■ ASME models

Back with lug type:

ID-C0512ENX, ID-C0512CENX, ID-C1012ENX, ID-C1012CENX

Flat back type*:

ID-C0512ENXB, ID-C0512CENXB, ID-C1012ENXB, ID-C1012CENXB

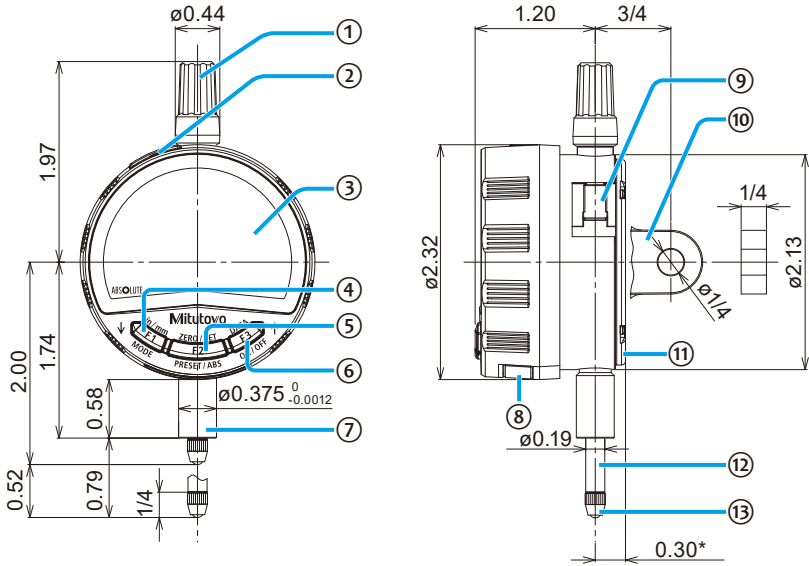

Unit: in

Tips

Dimensions with an asterisk (*) are for the flat back type. Dimensions without an asterisk (*) are common for the back with lug type and the flat back type.

⑨	Lifting lever mount (left and right)	⑫	Plunger
⑩	Back with lug	⑬	Contact point
⑪	Flat back		

1.2.2 Display (LCD)

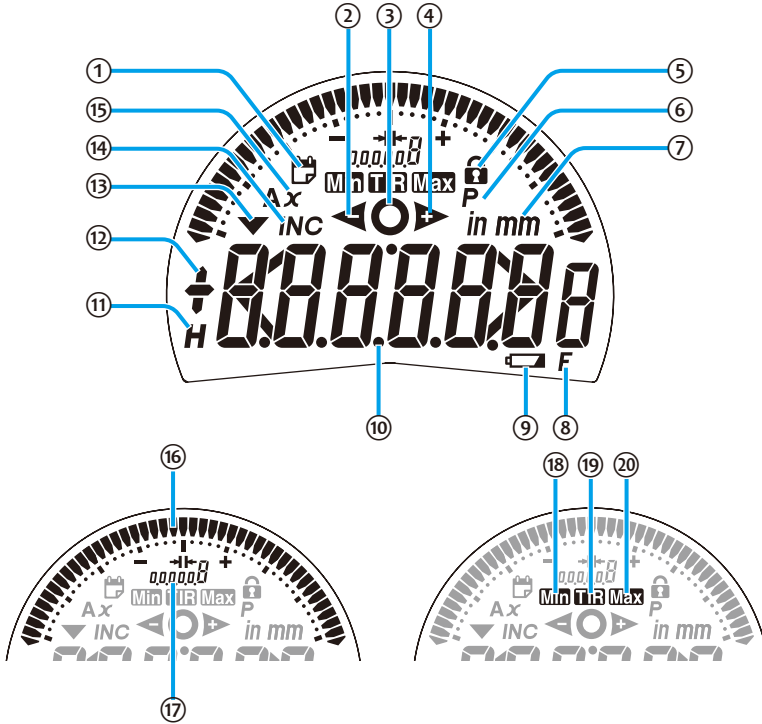

①	Calibration schedule warning display (☰ "5.11.2 Calibration Schedule Warning Selection/Setting" on page 66)	Tolerance judgment result display (OK) (☰ "5.6 Selecting the Tolerance Judgment Result Display Method and Setting Allowable Values" on page 46)
②	Tolerance judgment result display (-NG) (☰ "5.6 Selecting the Tolerance Judgment Result Display Method and Setting Allowable Values" on page 46)	Tolerance judgment result display (+NG) (☰ "5.6 Selecting the Tolerance Judgment Result Display Method and Setting Allowable Values" on page 46)

1 Overview

⑤	Function lock display (☰ "5.10 Setting Function Lock" on page 64)	⑬	Reverse counting display (☰ "5.4 Selecting Counting Direction" on page 42)
⑥	Preset display (☰ "4.1.1 Setting Origin and Preset Values" on page 22)	⑭	INC display (☰ "4.2 Incremental Measurement (INC)" on page 25)
⑦	Unit display (☰ "5.3 Selecting Unit System" on page 41)	⑮	Calculation function display (☰ "5.7 Setting Calculation Function Selection and Calculation Coefficient" on page 50)
⑧	Key customization display (☰ "4.6 Customizing Keys" on page 31)	⑯	Analog bar display (☰ "5.8 Selecting Analog Bar Display" on page 56)
⑨	Battery voltage decrease display (☰ "8 Error Displays and Countermeasures" on page 83)	⑰	Analog bar scale display (☰ "5.8 Selecting Analog Bar Display" on page 56)
⑩	Measured value display (tolerance judgment enlarged display) (☰ "5.6 Selecting the Tolerance Judgment Result Display Method and Setting Allowable Values" on page 46)	⑱	Minimum value detection display (☰ "4.3 Peak Detection" on page 26)
⑪	Hold display (☰ "4.5 Display Value Hold" on page 30)	⑲	Runout width detection display (☰ "4.3 Peak Detection" on page 26)
⑫	Sign display	⑳	Maximum value detection display (☰ "4.3 Peak Detection" on page 26)

1.2.3 Standard Accessories

- Battery holder opener



Tips

The upper hole can be used to attach a strap or similar to prevent loss.

- Weight (supplied with low measuring force types)



- Lithium metal battery CR2032 (for function verification, 1 pc.)
- User's manual with warranty
- Certificate of Inspection

2 Preparations before Use

2.1 Mounting to a Stand/Jig

Install the stem to the holder of the stand when making measurement with this product installed on a stand, etc.

NOTICE

Whenever possible, avoid fixing the stem directly with a set screw, etc.
The plunger may not be able to move smoothly if the screw is tightened with a tightening torque of 300 cN·m or more to secure the stem.

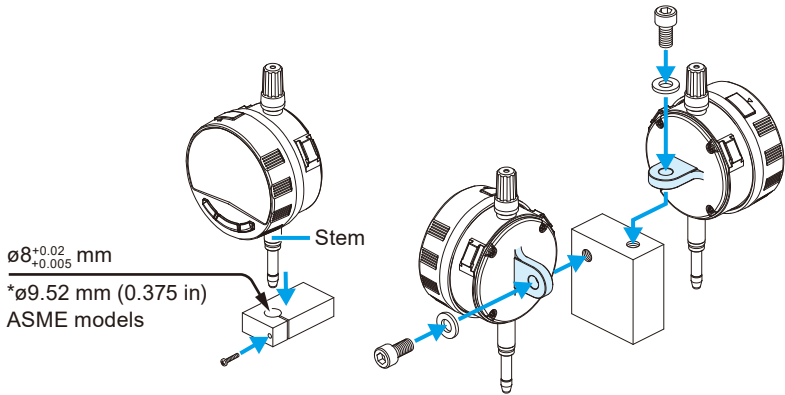

Tips

When mounting the product to a stand or jig, use the stem or back with lug. If using the stem, use a slotted holder with a hole that meets the following requirements.

ISO/JIS models: $\varnothing 8$ G7 (from +0.005 to +0.02) mm

ASME models: $\varnothing 9.52$ mm (0.375 in)

2.2 Mounting Options (Lifting Lever/Lifting Knob/Release)

An option (lifting lever, lifting knob, or release) can be mounted to allow the plunger to be raised indirectly.

NOTICE

- Using the product while the stop screw (supplied with the lifting lever) or lifting knob is not secured firmly may damage internal components or the workpiece.
- If not mounting a lifting lever, lifting knob, or release, always mount the original screw on top of the plunger. Otherwise internal components or the workpiece may be damaged.

2.2.1 Lifting Lever (Optional)

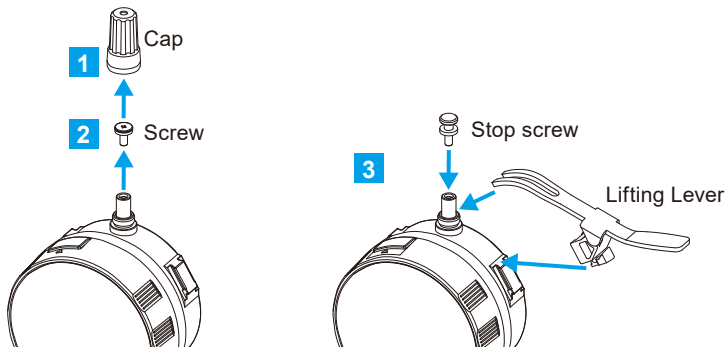

- 1** Rotate the cap counterclockwise to remove it from the product.
- 2** Fix the plunger, using pliers padded with a rag, etc., so that it does not turn, and then remove the screw (M2.5) on top of the plunger.
- 3** Mount the stop screw and, with the lever tip caught by the stop screw, mount the lifting lever on the lifting lever mount (dovetail).

Tips

Store the removed screw and cap to prevent loss.

2.2.2 Lifting Knob (Optional)

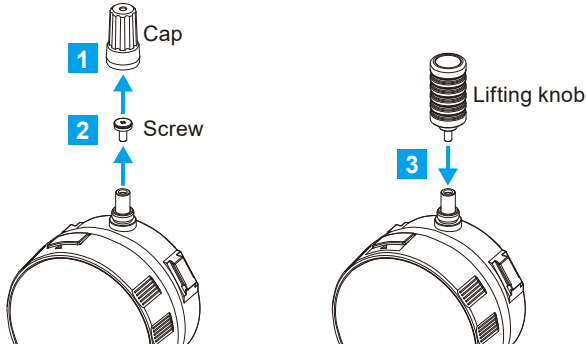

- 1** Rotate the cap counterclockwise to remove it from the product.
- 2** Fix the plunger, using pliers padded with a rag, etc., so that it does not turn, and then remove the screw (M2.5) on top of the plunger. During this process, push the plunger upward.
- 3** Mount the lifting knob on top of the plunger.

Tips

Store the removed screw and cap to prevent loss.

2.2.3 Release (Optional)

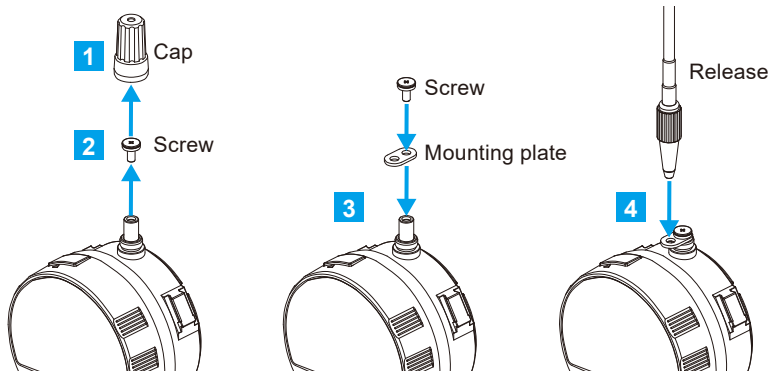

- 1** Rotate the cap counterclockwise to remove it from the product.

Tips

Store the removed cap to prevent loss.

- 2** Fix the plunger, using pliers padded with a rag, etc., so that it does not turn, and then remove the screw (M2.5) on top of the plunger.
- 3** Use the screw removed in step **2** to secure the mounting plate supplied with the release to the plunger.
- 4** Secure the tip of the release to the mounting plate.

2.3 Contact Point Replacement

When replacing the contact point, prepare two sets of pliers.

Various contact points are available as options. Refer to the Measuring Instruments Catalog for details.

NOTICE

When replacing the contact point, turn the contact point while fixing the plunger. Otherwise, the product may be damaged.

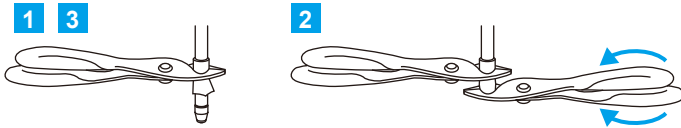

- 1** Cover the contact point and the vicinity of the plunger with a cloth, and pinch the plunger with pliers, etc.
- 2** Hold the contact point with another pair of pliers from the top of the cloth and remove the contact point.
- 3** Install a new contact point in the same manner as removal.

Tips

- Changing the contact point may cause changes in external dimensions and measuring force, or restrictions on the possible measurement directions.
- Errors due to the contact point (perpendicularity of flat contact point, center runout of roller contact point, etc.) are added to the measurement accuracy.

2.4 Display Angle Adjustment

The display can rotate up to 90° (A) clockwise or 240° (D) counterclockwise from the initial position. Adjust it to an angle from which it can be easily read.

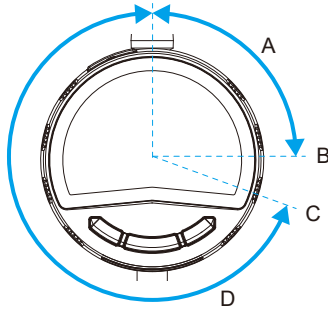

NOTICE

- Do not rotate beyond the stoppers at B and C positions. This may cause damage.
- Do not pull or push the display. This may cause damage.

3 Basic Usage

3.1 Precautions before Use

Dust, mist, or other substances could enter the gap between the plunger and main body, causing malfunction or failure. Avoid using the product in very dusty or misty environments.

3.2 Installing and Replacing the Battery

This product uses one lithium metal battery (CR2032).

The battery is not installed in the product at shipping. Install a battery before use.

CAUTION

- Be sure to use CR2032 (lithium metal battery) for the battery. The use of a different battery type may lead to explosions.
- Please note that you may damage your nails when removing the battery holder.

NOTICE

- Do not use a pointed object or excessive force to remove the battery holder. This may damage the battery holder.
- The product may be damaged or break down if the battery and battery holder are not mounted correctly.
- If the product will be out of use for 3 months or more, the device may be damaged due to battery leakage.

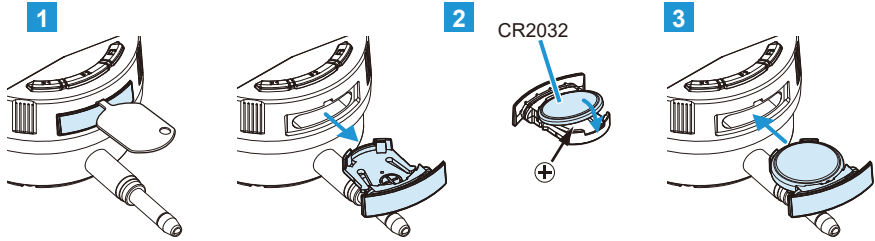

- 1 Remove the battery holder using a battery holder opener (standard accessory) or a flathead screwdriver.

Tips

If replacing a battery, remove the existing battery from the battery holder.

- 2 Insert the battery into the battery holder with the "+" symbol facing down.
- 3 Reattach the battery holder.

When the calibration schedule warning function is OFF:

- » The power turns ON and [-----] is displayed.



When the calibration schedule warning function is ON:

- » The power turns ON and [today] is displayed.



Tips

- If no value is displayed even when the above operation is performed, reinstall the battery.
- The battery provided is for confirming the functions and performance of the product. Note that this battery may not last for the entire expected life.

4 Press the [F2] key.

When the calibration schedule warning function is OFF:

- » The mode switches to measurement mode (current position display).



Measurement mode
(current position display)

When the calibration schedule warning function is ON:

- » The current date is displayed.

Press the [F2] key to confirm the current date. (Example: August 25, 2020)

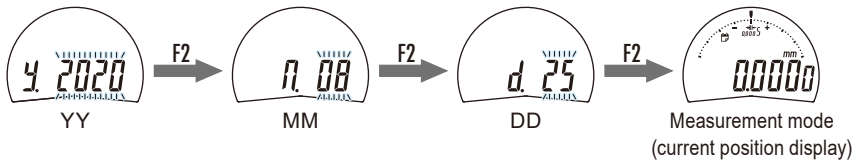
**Tips**

- To change the date, refer to step **3** in "5.11.2 Calibration Schedule Warning Selection/Setting" on page 66.
- For details on turning the calibration schedule warning ON and OFF, refer to "5.11.2 Calibration Schedule Warning Selection/Setting" on page 66.
- When the battery is replaced, the measurement mode will use the same display method and measurement system used prior to removing the battery.
Examples: Peak detection, absolute measurement (ABS)
- Dispose of batteries in accordance with the law and any other regulations.

3.3 Power ON/OFF

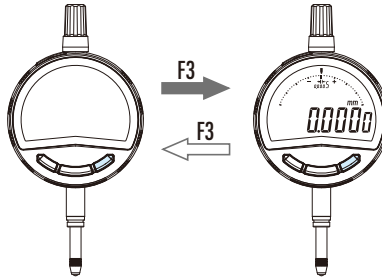

- Turning the power ON

Press the [F3] key.

- » The product starts up in measurement mode.

Tips

The measurement system when the power is turned ON is the same as it was when turned OFF. For details, refer to  "3.5 Switching Measurement Systems" on page 18.

- Turning the power OFF

Press and hold the [F3] key.

- » The LCD turns off.

Tips

Turning the power OFF while making settings will cancel the setting and return the product to the status before setting.

3.4 Measurement Mode and Parameter Setting Mode

This product has two modes: measurement mode and parameter setting mode.

3.4.1 Measurement Mode

This mode is used for tasks such as normal measurement, calculation measurement, tolerance judgment, holding displayed values, and outputting displayed values to an external device.

When in measurement mode, three methods for displaying measurement values are available for selection.

	Standard 1	Standard 2	Peak detection *1
Measured value display	Directly displays the measured value to be displaced.		Holds and displays the peak value of the measured value to be displaced.
Display of analog bar	Yes	No	Yes
Key customization *2	Customizable	Not customizable	Not customizable

*1: For details about peak detection, see  "4.3 Peak Detection" on page 26.

*2: For details about customization, see  "4.6 Customizing Keys" on page 31.

3.4.2 Parameter Setting Mode

This mode is used to set parameters. For details, see  "5 Setting Parameters" on page 35.

3.5 Switching Measurement Systems

This product can switch between the following two measurement systems according to the workpiece to be measured.

Measurement system	Explanation
Absolute measurement (ABS)	Sets (presets) the measurement origin and measures the dimensions of the workpiece. The measurement origin can be set to any desired value to support a wide range of workpieces.
Incremental measurement (INC)	Sets the reference point on the master to serve as a reference (zeros the displayed value), and then measures the difference between the master and a workpiece.

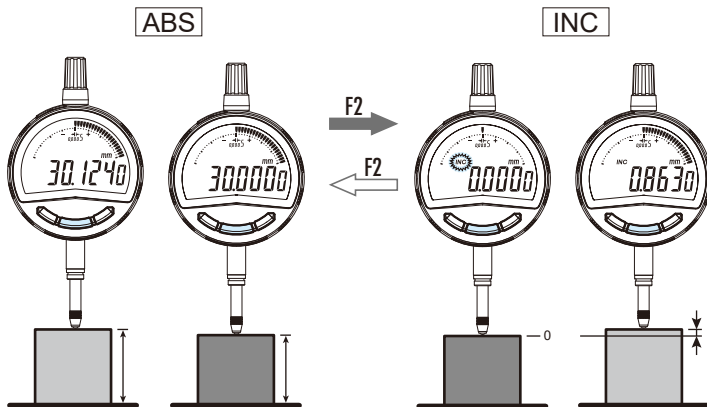

- Switching to absolute measurement (ABS)
Press and hold the [F2] key.
- Switching to incremental measurement (INC)
Press the [F2] key.

Tips

The displayed value is simultaneously reset to zero when switching from absolute measurement (ABS) to incremental measurement (INC).

3.6 Switching Unit System

The unit display can be switched between mm and in.

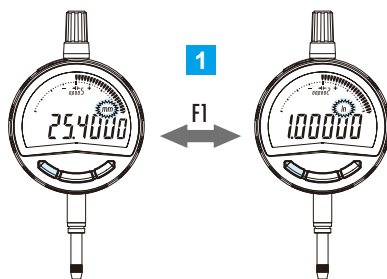

1 Press the [F1] key.

- » Each time the key is pressed, the unit display switches.

Tips

- This function is available only when the following measurement mode and switch function selection are set.

Measurement mode	Switch function selection
Standard 1	Default
Standard 1	[F1] key = [unit]
Standard 2	-

When peak detection is selected in measurement mode selection, this function cannot be used. Change units with unit system selection in the parameter setting mode.

For details about measurement mode selection, switch function selection and unit system selection, see  "5.1 Selecting Parameter Items" on page 35.

- When the unit is switched, the following will be converted accordingly: display value, preset values, tolerance value, resolution, and analog bar graduation.
- If it causes a display value overflow error (Err 30), set the proper resolution. For details, see  "8 Error Displays and Countermeasures" on page 83.
- Additionally, if there is an overflow or conversion error after switching units, checking the values of each setting is recommended.

MEMO

4 Measurement Method

4.1 Absolute Measurement (ABS)

Sets (presets) the measurement origin and measures the dimensions of the workpiece.

NOTICE

When setting or presetting the origin, be sure to lift the plunger at least 0.2 mm from the bottom of the stroke.

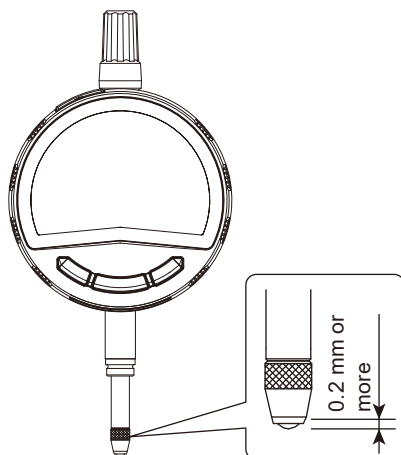

4.1.1 Setting Origin and Preset Values

Tips

If not changing the preset value, continue to step 1 -3 in "4.1.2 Measurement Operations" on page 24.

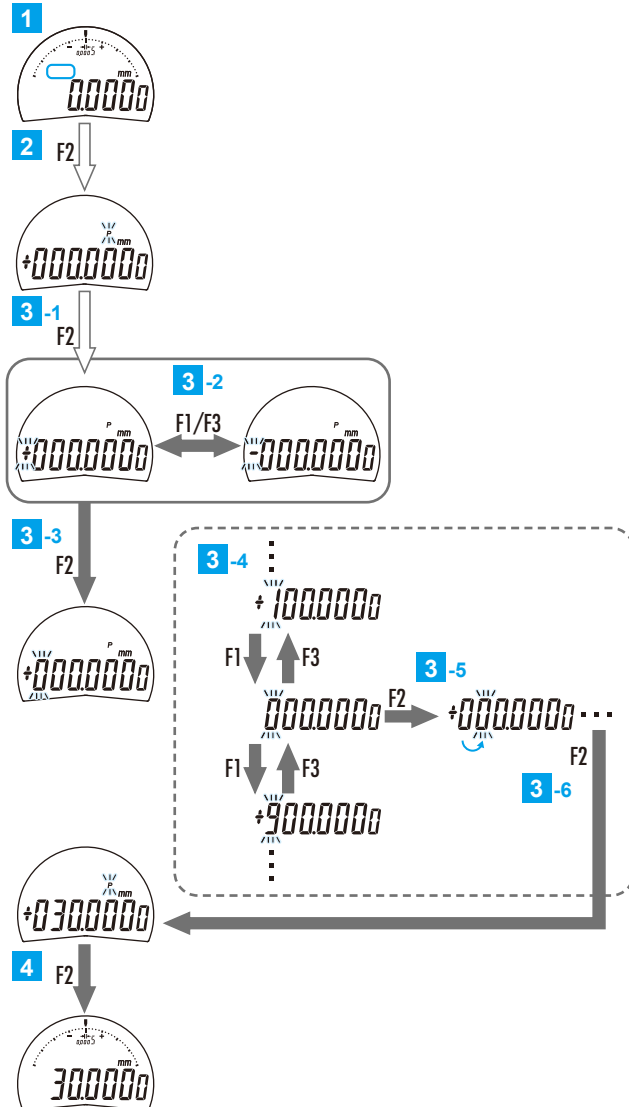

- 1 Confirm that the product is in absolute measurement (INC display is turned off).**

Tips

If set to incremental measurement, switch the measurement system to absolute measurement. For details, see  "3.5 Switching Measurement Systems" on page 18.

- 2 Press and hold the [F2] key to start the origin setting (presetting).**

» Preset display ([P]) will blink and the previous preset value will be displayed.

- 3 Setting the preset value**

- 1** Press and hold the [F2] key.

» The sign will blink and the preset value can be changed.

- 2** Press the [F1] key or [F3] key.

» Each time the key is pressed, it will switch the sign.

- 3** Press the [F2] key.

» The sign is confirmed and the neighboring digit blinks.

- 4** Press the [F1] key or [F3] key.

» Each time the key is pressed, the value will change by one.

- 5** Press the [F2] key.

» The number is confirmed and the neighboring digit blinks.

» Each time the key is pressed, the blinking digit moves to the right.

- 6** Repeat steps 4 to 5 above until the numbers for all digits are confirmed.

» Confirming the last digit will cause preset display ([P]) to blink.

- 4 Press the [F2] key to exit the origin setting (presetting).**

» The preset display turns off and the setting is concluded.

Tips

- Press and hold the [F1] key to cancel the preset setting.
- If the preset value is incorrect, press and hold the [F2] key and redo from step **3**.

4.1.2 Measurement Operations

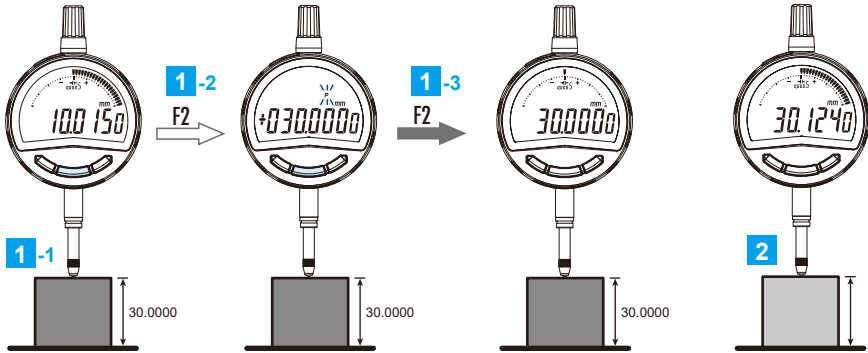

1 Determining the origin (origin point)

- 1 Set the master to use for reference.
- 2 Press and hold the [F2] key.
 - » The preset display ([P]) blinks and the previously set preset value (e.g. 30.0000 mm) is displayed.
- 3 Confirm the preset value, and then press the [F2] key.
 - » The measurement origin is set as the preset value and it becomes measurable.

Tips

- The set preset value and origin are retained even when the power is turned off. However, the preset value is cleared when All Reset is performed and must be reset.
- The preset value is automatically converted when the unit system or resolution is changed. In this case, however, a conversion error may be produced. It is therefore recommended to check the preset value after changing the unit system or resolution.

2 Replace the master with the workpiece and perform absolute measurement.

4.2 Incremental Measurement (INC)

Zeros the dimensions of the master to use as reference and measures the dimensional difference with the workpiece.

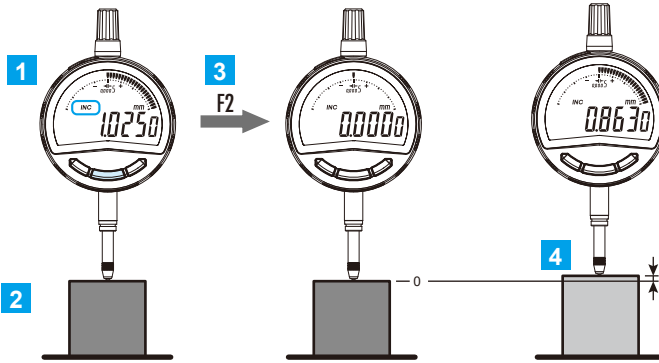

- 1 Confirm that the product is in incremental measurement (INC display is turned on).

Tips

If set to absolute measurement, switch the measurement system to incremental measurement. For details, see "3.5 Switching Measurement Systems" on page 18.

- 2 Set the master to use for reference.
- 3 Press the [F2] key.
 - » The displayed value is set to zero.
- 4 Replace the master with the workpiece and perform incremental measurement.

4.3 Peak Detection

During peak detection, measurement is performed while the workpiece is moved and rotated with the contact point touching the workpiece. The displayed value can be switched between the runout width (TIR), the maximum value (Max), and the minimum value (Min) detected as the displacement peak value.

- Current value display

Current measurement value is always displayed.

- Runout width (TIR) display

The runout width (maximum value - minimum value) is always displayed relative to the displacement of the measured value. [Max] or [Min] blinks when the maximum and minimum values are updated.

Tolerance judgment results are displayed with respect to the runout.

Tips

- When [Auto] is selected in "Analog bar display selection" in the parameter setting mode, the analog bar scale automatically changes so that the pointer of the analog bar is always within the display range with respect to the displacement of the measured value.
- For tolerance judgment, the set upper/lower limit width is compared with the measured runout width.

- Maximum value (Max) display

The maximum value is always displayed relative to the displacement of the measured value. [Max] blinks when the maximum values are updated.

Tolerance judgment results are displayed with respect to the maximum value.

Tips

- In absolute measurement, it is possible to preset any maximum value and perform measurement based on that position. For preset settings, refer to  "4.1.1 Setting Origin and Preset Values" on page 22 in "4.1 Absolute Measurement (ABS)".
- If the pointer on the analog bar exceeds the display range with respect to the displacement of the measured value, the pointer automatically returns to the center position.

● Minimum value (Min) display

The minimum value is always displayed relative to the displacement of the measured value. [Min] blinks when the minimum values are updated.

Tolerance judgment results are displayed with respect to the minimum value.

Tips

- In absolute measurement, it is possible to preset any minimum value and perform measurement based on that position. For preset settings, refer to  "4.1.1 Setting Origin and Preset Values" on page 22 in "4.1 Absolute Measurement (ABS)".
- If the pointer on the analog bar exceeds the display range with respect to the displacement of the measured value, the pointer automatically returns to the center position.

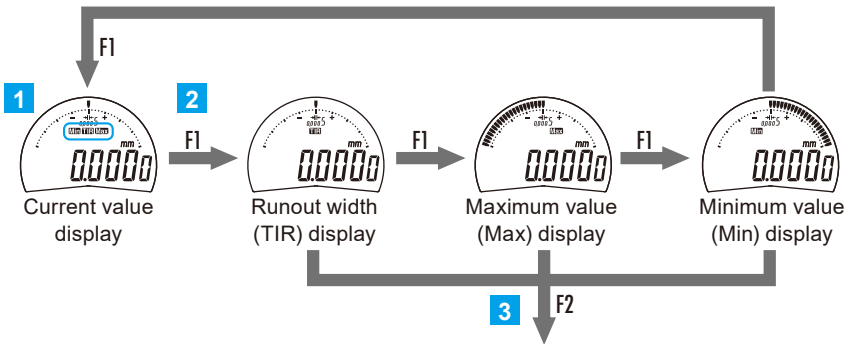

1 Make sure that the measurement mode is set to peak detection (peak detection display is lit).

Tips

- For details on switching the display method in measurement mode, refer to  "5.2 Selecting Measurement Mode" on page 40.
- Peak detection begins once the display method in measurement mode switches to peak detection.

2 Press the [F1] key to switch to peak detection display.

- » Each time the key is pressed, it will switch the peak detection display.

3 Press the [F2] key to reset the peak value and begin measuring.

» The selected peak detection display value is displayed.



For peak detection, start measurement with the contact point in contact with the target to be measured.

Tips

- Be careful during measurement as displacement due to vibration or impact is also detected.
- Peak detection will continue until the [F2] key is pressed again. To start a new peak detection, press [F2] key to reset the peak value.
- The displayed values can be held during peak detection. For details, see  "4.5 Display Value Hold" on page 30.
- By switching the measurement mode to peak detection while holding, the amplitude, maximum value and minimum value that are being held can be checked. While the display value is being held, it will not switch to the current value display.

4.4 Tolerance Judgment

The upper/lower limit allowable values can be set to provide a GO/NG judgment for the measured value (pass/fail judgment).

Allowable values can be set independently for absolute measurement (ABS)/incremental measurement (INC).

For information on setting, refer to  "5.6 Selecting the Tolerance Judgment Result Display Method and Setting Allowable Values" on page 46.

● Displaying tolerance judgment results

Normal display
(measured value
and judgment result)



Enlarged display
(judgment result
only)

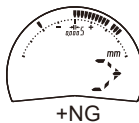
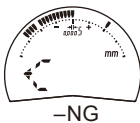

4.5 Display Value Hold

If an external device is not connected, the displayed value can be held (fixed).

Tips

During tolerance judgment enlarged display, the Hold function will not work. For information on the tolerance judgment enlarged display, refer to  "4.4 Tolerance Judgment" on page 29.

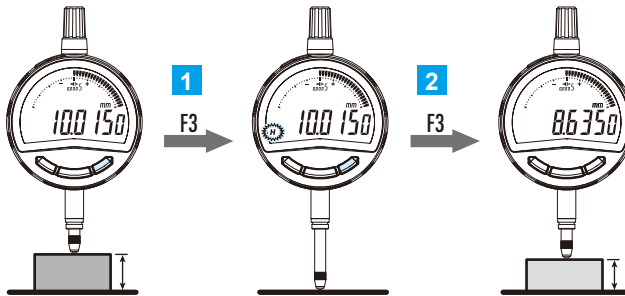

1 Press the [F3] key.

- » Hold display ([H]) will appear and the displayed value will be held (the displayed value will be retained even if the workpiece is removed).

2 Press the [F3] key while the displayed value is held.

- » Hold display ([H]) turns off and hold is released (displays current plunger position).

4.6 Customizing Keys

Depending on how this product is used, it is possible to customize the functions assigned to short-pressing of each key ([F1] key, [F2] key, [F3] key).

Each key can be customized using "Switch function selection" in the parameter setting mode. For details, see  "5.9 Selecting Switch Function" on page 60.

Example 1:

[F1] key	[F2] key	[F3] key
[dir] Counting direction switching	[P.CALL] Preset recall	[hoLd] Display value hold

Example 2:

[F1] key	[F2] key	[F3] key
[nonE] No function	[ZEro] Zero setting	[nonE] No function



Tips

- Key customization is available only when the measurement mode is in "Standard 1".
- To return to the default function assignment after customizing the key, change the switch function selection to "default ([dEF])". For details, see  "5.9 Selecting Switch Function" on page 60.

4.7 Externally Outputting the Displayed Value

Display values can be output to various external devices (external display, external printer, PC, etc.) by connecting a connection cable to this product.

Tips

- For connection cables (optional) that can be connected to this product, refer to  "11 Accessories (Optional)" on page 103.
- Refer to  "9 Input/Output Functions" on page 89 for details about pin assignments of connection cables, output data format, and timing chart.
- Carefully read the User's Manual of the data processing device to be connected when using the External Output function.

4.7.1 Connecting with External Devices

NOTICE

Do not pull the connection cable with force. This may cause damage.

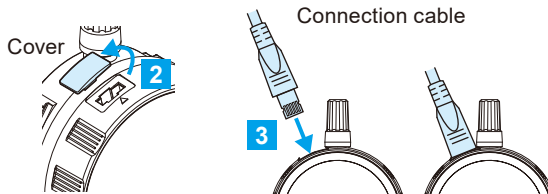

1 Press and hold the [F3] key.

» Power turns off.

2 Remove the cover of the I/O connector of this product.

Tips

- Store the removed cover to prevent loss.
- Always install the cover if a connection cable is not used.

3 Connect the connection cable to this product.



When inserting a connection cable, pay attention to the connector direction (align the ▲ marks).

4 Connect the other end to the external device.



When removing the connection cable, hold the connector on the tip.

4.7.2 External Output Operation

The displayed value is output to the connected external device.

This operation is enabled only when this product is connected to an external device.

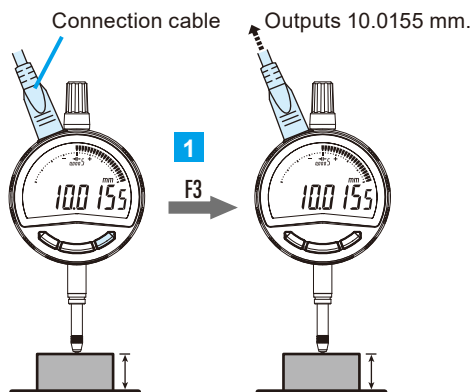

1 Press the [F3] key while in measurement mode.

» The displayed value is output to the connected external device.

Tips

- If inputting an output request (REQ) from the connected external device, do so only when the plunger is stopped. If an output request (REQ) is input while the plunger is moving, it may output an incorrect value or data output may not be possible.
- If output requests (REQ) are input over short intervals, data output may not be possible.
- External output using the [F3] key is not possible during tolerance judgment enlarged display. The measured value is externally output only when an output request (REQ) from an external device is received.

MEMO

5 Setting Parameters

5.1 Selecting Parameter Items

The parameter setting mode includes the following parameter items.

- ID-C0512NX, ID-C0512NXB, ID-C0512CNX, ID-C0512CNXB: 9 types
- ID-C0512MNX, ID-C0512MNXB, ID-C0512ENX, ID-C0512ENXB, ID-C0512CMNX, ID-C0512CMNXB, ID-C0512CENX, ID-C0512CENXB: 10 types
- ID-C1012NX, ID-C1012NXB, ID-C1012CNX, ID-C1012CNXB: 8 types
- ID-C1012MNX, ID-C1012MNXB, ID-C1012ENX, ID-C1012ENXB, ID-C1012CMNX, ID-C1012CMNXB, ID-C1012CENX, ID-C1012CENXB: 9 types

■ List of parameters

Display	Setting details	Default setting
ModE	Measurement mode selection	Standard 1
unit	Unit system selection (ID-C0512MNX, ID-C0512MNXB, ID-C0512ENX, ID-C0512ENXB, ID-C1012CMNX, ID-C1012CMNXB, ID-C0512CENX, ID-C0512CENXB, ID-C1012MNX, ID-C1012MNXB, ID-C1012ENX, ID-C1012ENXB, ID-C1012CMNX, ID-C1012CMNXB, ID-C1012CENX, ID-C1012CENXB)	in
dir.	Counting direction selection	Positive direction
rES.	Resolution selection (ID-C0512NX, ID-C0512NXB, ID-C0512MNX, ID-C0512MNXB, ID-C0512ENX, ID-C0512ENXB, ID-C0512CNX, ID-C0512CNXB, ID-C0512CMNX, ID-C0512CMNXB, ID-C0512CENX, ID-C0512CENXB)	0.0005 mm 0.00002 in
toL.	Tolerance judgment result display selection and allowed value setting	Display OFF
CALC.	Calculation function selection and calculation coefficient setting	Calculation OFF
A-bAr	Analog bar display selection	Display ON
S-SEL	Switch function selection	Default
F-Loc	Function lock setting	Lock OFF

othEr	Change other functions	-
CAL.Alt	Calibration schedule warning selection/setting	Warning OFF
outPut	Digimatic output selection (ID-C0512NX, ID-C0512NXB, ID-C0512MNX, ID-C0512MNXB, ID-C0512ENX, ID-C0512ENXB, ID-C0512CNX, ID-C0512CNXB, ID-C0512CMNX, ID-C0512CMNXB, ID-C0512CENX, ID-C0512CENXB)	DIGIMATIC d2
Auto.oF	Auto OFF setting	OFF
rESEt	All reset	-

■ Display order of parameter items

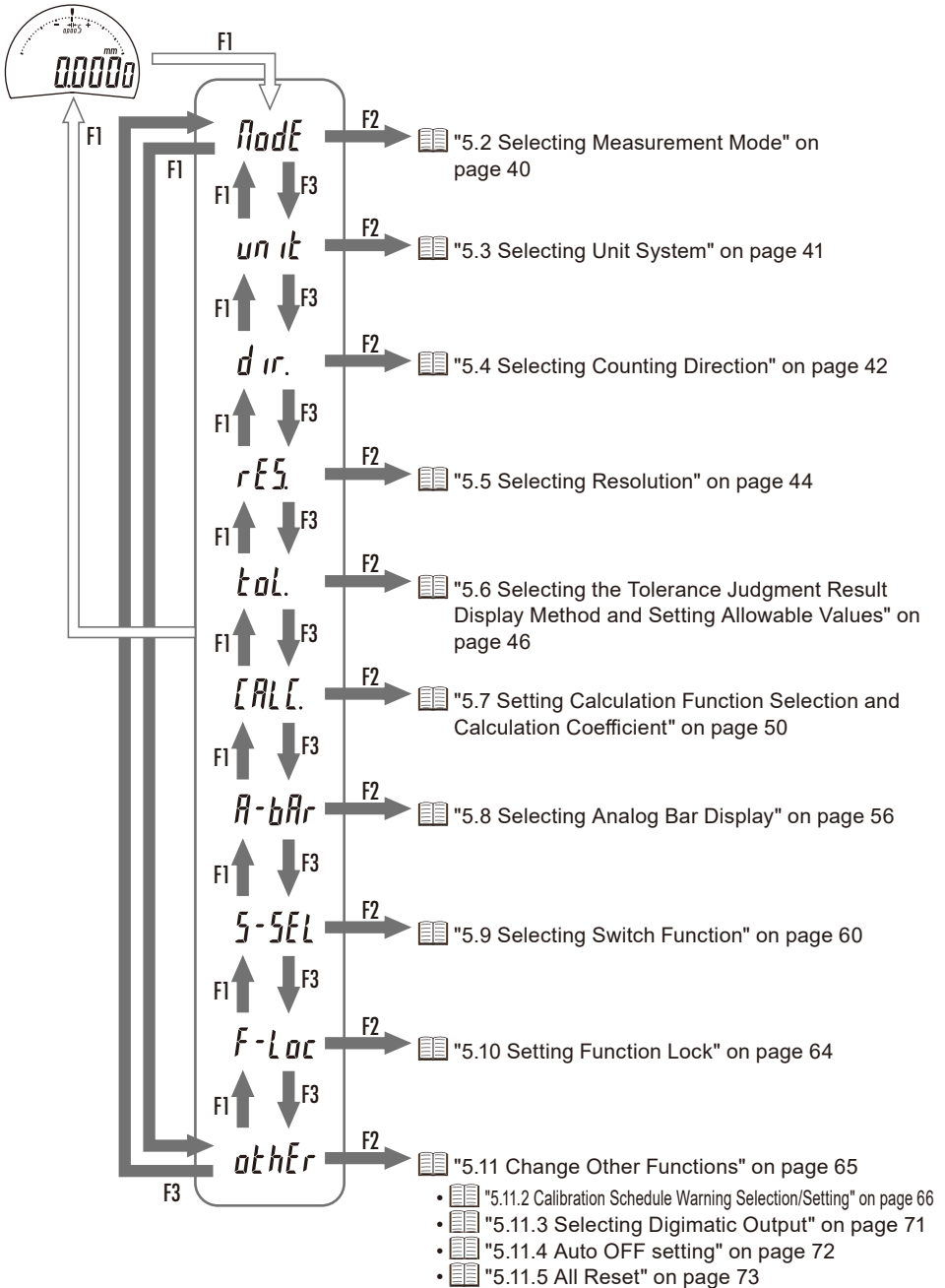

Tips

- Press and hold the [F1] key to cancel the parameter setting. Note that unconfirmed settings will not be reflected.
- Parameter settings are retained even when the power is turned off. However, when All Reset is performed, the settings will be reset to the factory defaults.

5.2 Selecting Measurement Mode

The measurement mode can be selected from "Standard 1", "Standard 2" and "Peak Detection".

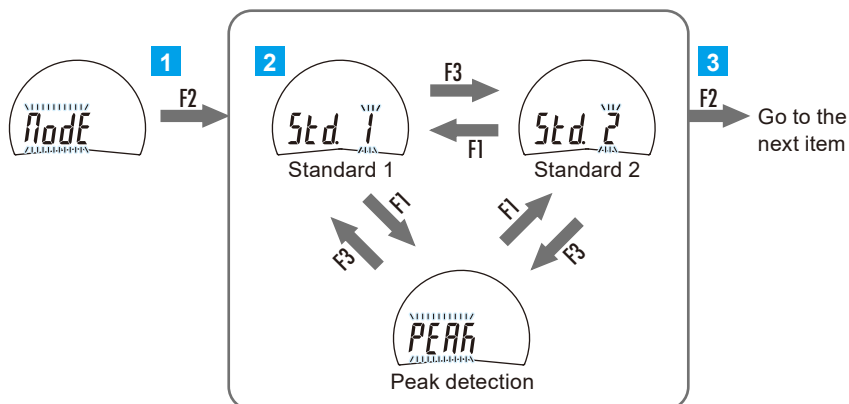

1 Press the [F2] key.

- » Measurement mode can be set.

2 Press the [F1] key or [F3] key to set the measurement mode.

- » Each time the key is pressed, it will switch the measurement mode in order.

3 Press the [F2] key.

- » Settings are confirmed; shifts to the next parameter item.
(Go to "5.3 Selecting Unit System" on page 41.)

Tips

Standard (1, 2) and peak detection have different function assignments when respective key ([F1] key, [F2] key, [F3] key) is short pressed.

Measurement mode	[F1] key	[F2] key	[F3] key
Standard 1	Customizable (Initial settings: "N/A", "Zero setting", "Data hold")		
Standard 2	Unit switching	Zero setting	Data hold
Peak detection	Peak detection display switching	Peak detection start	Data hold

5.3 Selecting Unit System

The unit system (in ↔ mm) can be set (excluding ID-C0512NX, ID-C0512NXB, ID-C0512CNX, ID-C0512CNXB, ID-C1012NX, ID-C1012NXB, ID-C1012CNX, ID-C1012CNXB).

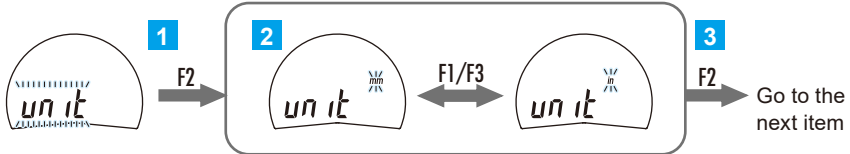

1 Press the [F2] key.

- » Unit system can be set.

2 Press the [F1] key or [F3] key to set the unit system.

- » Each time the key is pressed, it will switch between [in] and [mm].

3 Press the [F2] key.

- » Settings are confirmed; shifts to the next parameter item.
(Go to  "5.4 Selecting Counting Direction" on page 42.)

5.4 Selecting Counting Direction

The counting direction can be selected with regard to the plunger movement direction.

Positive counting



Negative counting

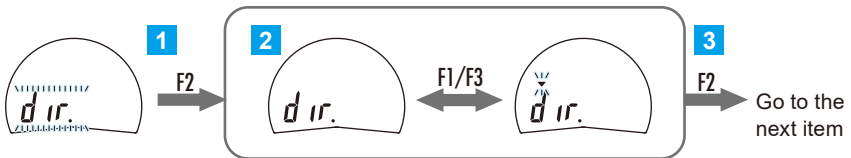

1 Press the [F2] key.

» The counting direction can be selected.

2 Press the [F1] key or [F3] key to select the counting direction.

[▼] OFF: Counts up (positive counting) when the plunger is raised.

[▼] Blinking: Counts down (negative counting) when the plunger is raised.

» Each time the key is pressed, it will switch the counting direction.

3 Press the [F2] key.

» Settings are confirmed; shifts to the next parameter item.

(Go to "5.5 Selecting Resolution" on page 44.)

MEMO

5.5 Selecting Resolution

For the following models, the minimum display amount can be selected.

ID-C0512NX, ID-C0512NXB, ID-C0512MNX, ID-C0512MNXB,
 ID-C0512ENX, ID-C0512ENXB, ID-C0512CNX, ID-C0512CNXB,
 ID-C0512CMNX, ID-C0512CMNXB, ID-C0512CENX, ID-C0512CENXB

When the unit system is mm (ID-C0512NX, ID-C0512NXB, ID-C0512CNX, ID-C0512CNXB):

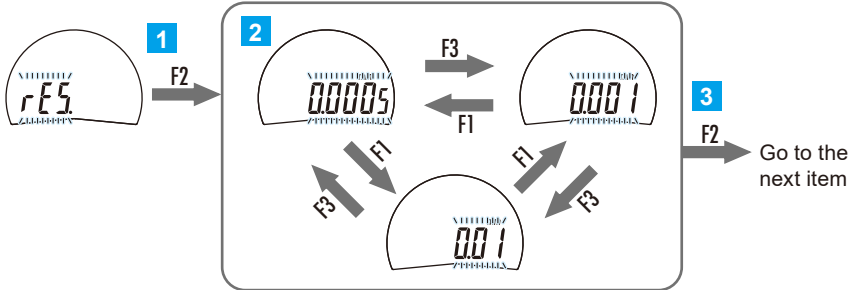

When the unit system is inch (ID-C0512MNX, ID-C0512MNXB, ID-C0512ENX, ID-C0512ENXB, ID-C0512CMNX, ID-C0512CMNXB, ID-C0512CENX, ID-C0512CENXB):

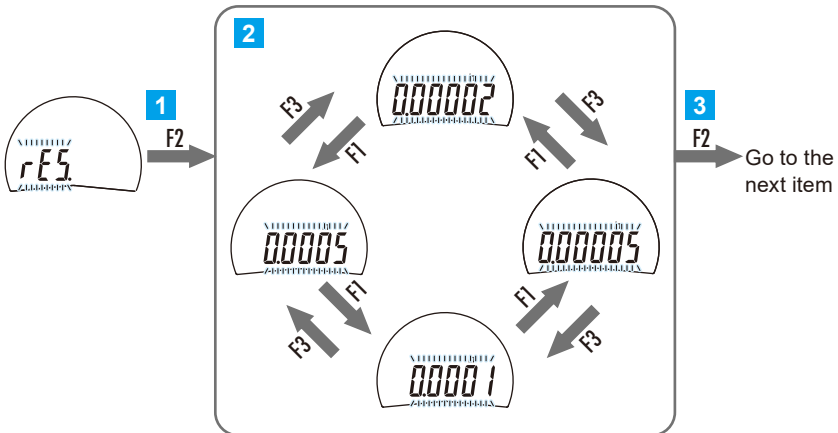

1 Press the [F2] key.

- » Resolution can be set.

2 Press the [F1] key or [F3] key to set the resolution.

- » Each time the key is pressed, it will switch the resolution.

3 Press the [F2] key.

- » Settings are confirmed; shifts to the next parameter item.
(Go to  "5.6 Selecting the Tolerance Judgment Result Display Method and Setting Allowable Values" on page 46.)

5.6 Selecting the Tolerance Judgment Result Display Method and Setting Allowable Values

The display method during tolerance judgment can be selected, and the allowable values (upper limit value and lower limit value) can be set. Allowable values can be set independently for each measurement system (absolute measurement (ABS) and incremental measurement (INC)).

Tips

For the method for switching between absolute measurement (ABS)/incremental measurement (INC), refer to [☰](#) "4.1 Absolute Measurement (ABS)" on page 21 and [☰](#) "4.2 Incremental Measurement (INC)" on page 25.

5.6.1 Setting Display Method

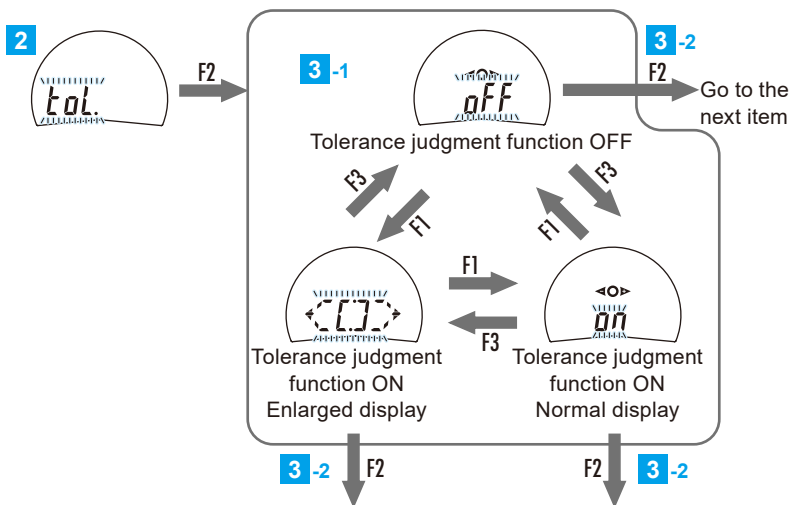

Setting allowable values (upper limit value and lower limit value)

- 1 Confirm that the measurement system to which the Tolerance Judgment function is applied is selected.

Tips

For the method for switching between absolute measurement (ABS)/incremental measurement (INC), refer to [☰](#) "3.5 Switching Measurement Systems" on page 18.

- 2 Press the [F2] key.

» Tolerance Judgment function can be set.

3 Setting the measurement result display method

- 1 Press the [F1] key or [F3] key.
 - » Each time the key is pressed, it will switch the display method.

- 2 Press the [F2] key.

When "Tolerance judgment function ON (normal display or enlarged display)" is selected:

- » [▶] will blink and the previously set upper limit value will be displayed.

To skip the upper limit setting, press the [F2] key again.

(Go to step 2 in  "5.6.2 Setting Allowable Values (Upper Limit Value and Lower Limit Value)" on page 48.)

When "Tolerance judgment function OFF" is selected:

- » Settings are confirmed; shifts to the next parameter item.

(Go to  "5.7 Setting Calculation Function Selection and Calculation Coefficient" on page 50.)

Tips

When "peak detection" is selected in measurement mode selection, "enlarged display" cannot be selected.

5.6.2 Setting Allowable Values (Upper Limit Value and Lower Limit Value)

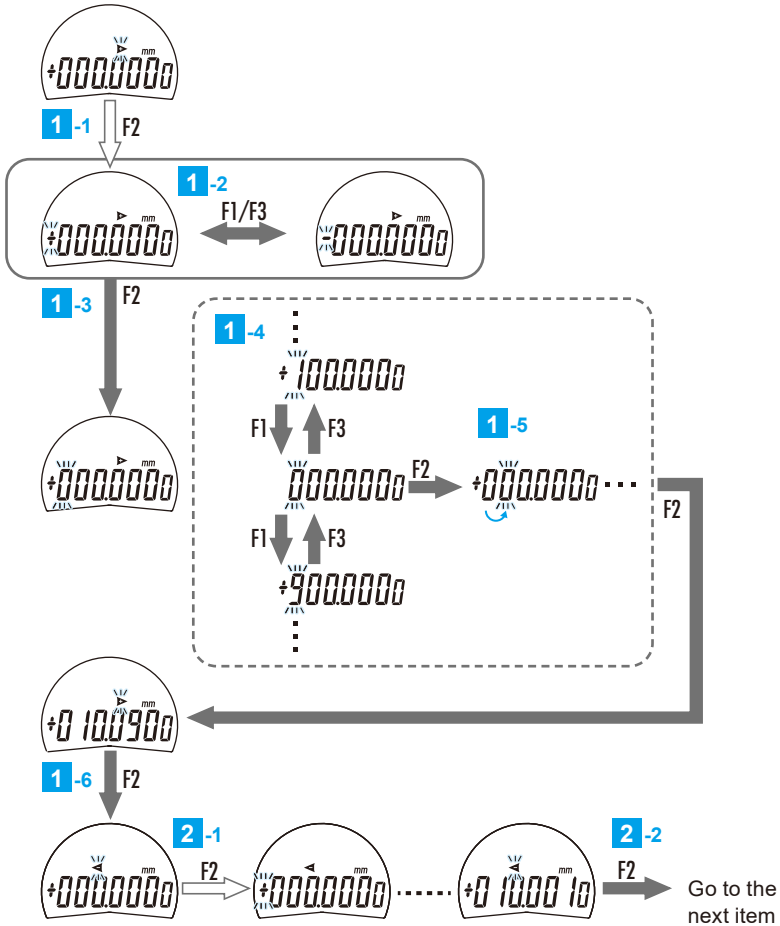

1 Setting the upper limit

- 1 Press and hold the [F2] key.
 - » The sign will blink and can be changed.
 - » Continue to 3 if not changing the sign.
- 2 Press the [F1] key or [F3] key.
 - » Each time the key is pressed, it will switch the sign.

- 3 Press the [F2] key.
 - » The sign is confirmed and the neighboring digit blinks.
- 4 Press the [F1] key or [F3] key.
 - » Each time the key is pressed, the value will change by one.



- 5 Press the [F2] key.
 - » The number is confirmed and the neighboring digit blinks.
 - » Each time the key is pressed, the blinking digit moves to the right.

Repeat steps 4 to 5 above until the numbers for all digits are confirmed.

- » Confirming the last digit will cause  to blink.

- 6 Press the [F2] key.
 - » The upper limit setting is confirmed.
 - »  will blink and the previously set upper limit value will be displayed.

2 Setting the lower limit

- 1 Set in the same way as the upper limit (step .
- 2 Press the [F2] key.
 - » Settings are confirmed; shifts to the next parameter item.
(Go to  "5.7 Setting Calculation Function Selection and Calculation Coefficient" on page 50.)

Tips

- Press and hold the [F1] key to stop or cancel settings midway through.
- If the upper limit is set below the lower limit, the error display [Err 90] appears and the set value will not be reflected. Clear the error display by pressing the [F2] key and, starting with the upper limit, reset so that the upper limit is above the lower limit. ( "8 Error Displays and Countermeasures" on page 83)
- Allowable values cannot be set for "normal display" and "enlarged display" separately.
- Allowable values are automatically converted when the resolution is changed. In this case, however, a conversion error may be produced. It is therefore recommended to check the allowable values after changing the resolution.

5.7 Setting Calculation Function Selection and Calculation Coefficient

In addition to normal measurement, this product can also perform calculation measurement, in which results are displayed by multiplying the plunger movement amount by a calculation coefficient.

Tips

Using the calculation function, the movement amount of the plunger can be calculated and displayed as a radius difference as shown below.

In the figure below, the calculation coefficient (A) is as follows.

$$R = Ax \quad A = -\frac{\sin \theta/2}{1 - \sin \theta/2} = -\frac{\sin 60^\circ}{1 - \sin 60^\circ} = -6.4641$$

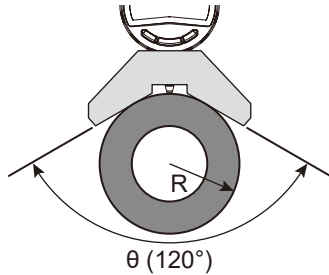

Absolute value display (ABS): Radius value display

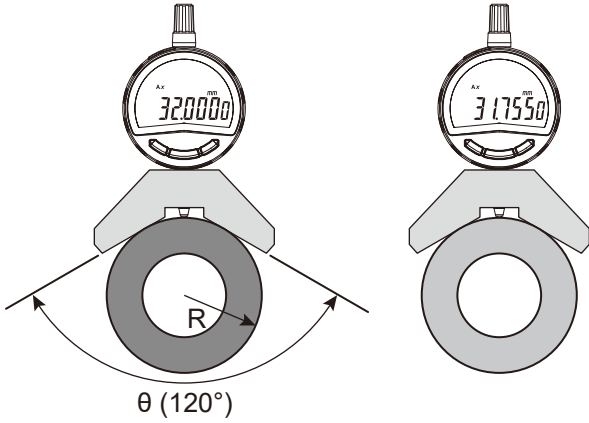

Preset value + A x Plunger movement amount

Incremental measurement (INC): Radius difference display

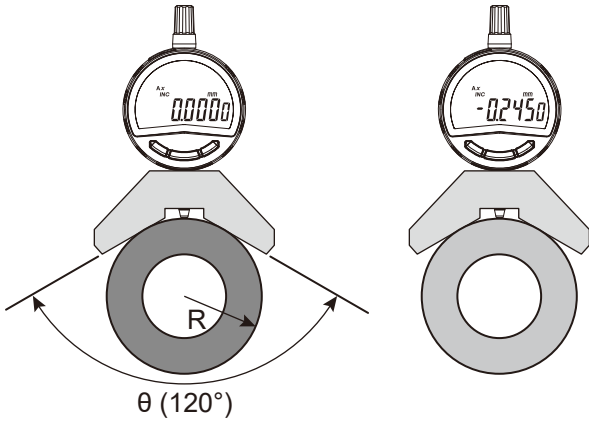

A x Plunger movement amount

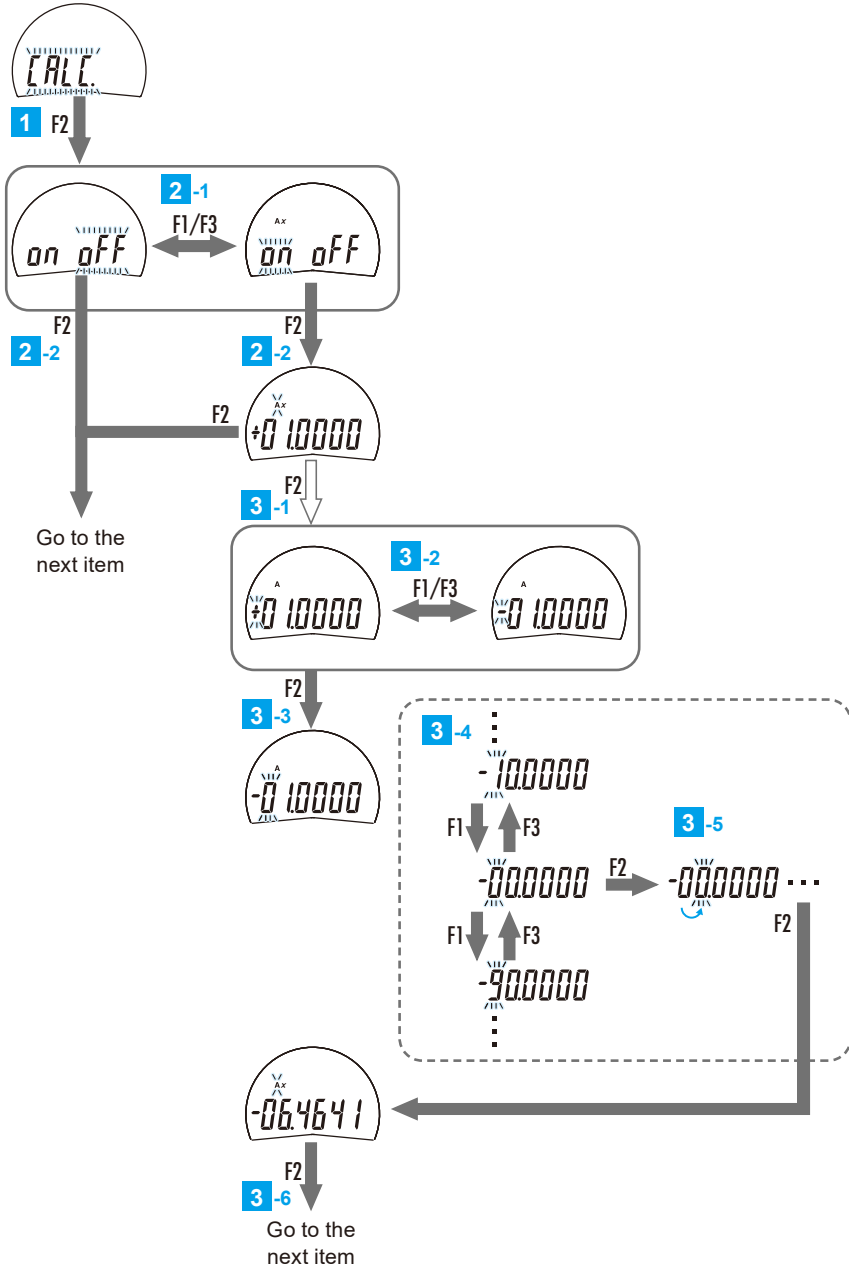

1 Press the [F2] key.

- » Calculation function can be set.

2 Setting the execution/stop of the calculation function

- 1 Press the [F1] key or [F3] key.
 - » Each time the key is pressed, it will switch execution/stop.
- 2 Press the [F2] key.

When execution [on] is selected:

- » The calculation function display (A) blinks and the previously set calculation coefficient is displayed.

Tips

If the displayed calculation coefficient is correct, press the [F2] key. Calculation coefficient is confirmed; shifts to the next parameter item.

When stop [oFF] is selected:

- » Selection is confirmed; shifts to the next parameter item.
(Go to  "5.8 Selecting Analog Bar Display" on page 56.)

3 Setting the calculation coefficient

- 1 Press and hold the [F2] key.
 - » The sign will blink and can be changed.
 - » Continue to **3** if not changing the sign.
- 2 Press the [F1] key or [F3] key.
 - » Each time the key is pressed, it will switch the sign.
- 3 Press the [F2] key.
 - » The sign is confirmed and the neighboring digit blinks.
- 4 Press the [F1] key or [F3] key.
 - » Each time the key is pressed, the value will change by one.
- 5 Press the [F2] key.
 - » The number is confirmed and the neighboring digit blinks.
 - » Each time the key is pressed, the blinking digit moves to the right.

Repeat steps **4** to **5** above until the numbers for all digits are confirmed (e.g.: -6.4641).

- » Confirming the last digit will cause the calculation function display (A) to blink.

- 6 Reconfirm the numerical value set and press the [F2] key.
 - » Calculation coefficient is confirmed; shifts to the next parameter item.
(Go to  "5.8 Selecting Analog Bar Display" on page 56.)

Tips

- Press and hold the [F1] key to stop or cancel settings midway through.
- As a result of calculation processing, a display value overflow error (Err 30) may occur. For details, see  "8 Error Displays and Countermeasures" on page 83.
- The default setting of the calculation coefficient is $A = 1$.
- If the calculation coefficient A is set to 00.0000, a calculation coefficient setting error (Err 91) will occur. Press the [F2] key and reset it so that $A \neq 0$.
- Calculation coefficient is not converted even when the unit system or resolution is switched.

MEMO

5.8 Selecting Analog Bar Display

The analog bar display can be turned ON/OFF. In addition, settings of the displayed analog bar scale (± 20) can be changed.

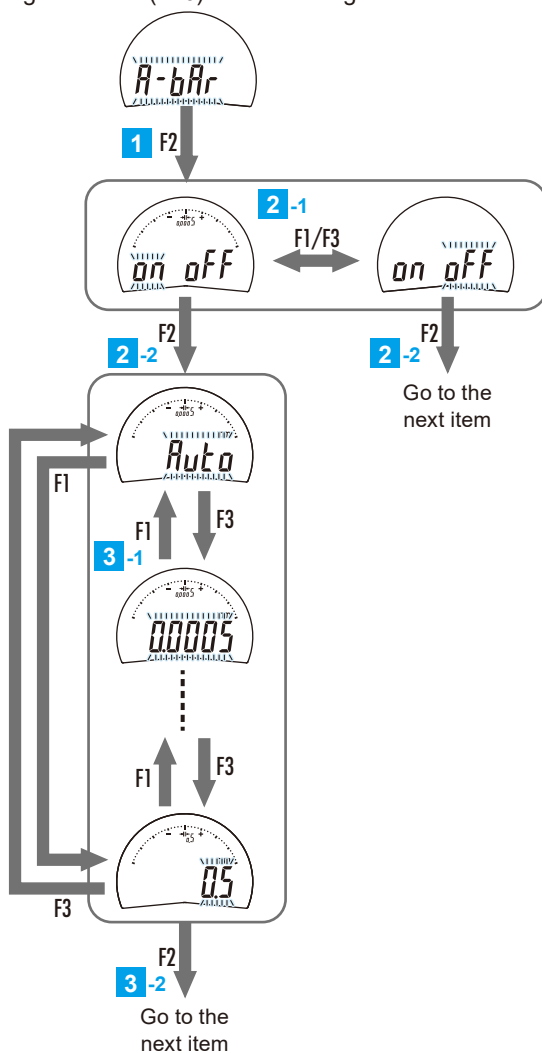

1 Press the [F2] key.

- » Analog bar display can be set.

2 Select ON/OFF for the analog bar display.

- 1 Press the [F1] key or [F3] key.
 - » Each time the key is pressed, the analog bar display turns ON/OFF alternately.
- 2 Press the [F2] key.

If analog bar display ON [on] is selected:

- » Analog bar scale can be set.

When analog bar display OFF [oFF] is selected:

- » Selection is confirmed; shifts to the next parameter item.
(Go to  "5.9 Selecting Switch Function" on page 60.)

3 Setting the analog bar scale

- 1 Press the [F1] key or [F3] key.
 - » Each time the key is pressed, the setting of the analog bar scale changes.

ID-C0512NX, ID-C0512NXB, ID-C0512CNX, ID-C0512CNXB

mm
Auto
0.0005
0.001
0.002
0.005
0.01
0.02
0.05
0.1
0.2
0.5

ID-C1012NX, ID-C1012NXB, ID-C1012CNX, ID-C1012CNXB

mm
Auto
0.01
0.02
0.05
0.1
0.2
0.5

**ID-C0512MNX, ID-C0512MNXB, ID-C0512ENX, ID-C0512ENXB,
ID-C0512CMNX, ID-C0512CMNXB, ID-C0512CENX, ID-C0512CENXB**

mm	in
Auto	Auto
0.0005	0.00002
0.001	0.00005
0.002	0.0001
0.005	0.0002
0.01	0.0005
0.02	0.001
0.05	0.002
0.1	0.005
0.2	0.01
0.5	0.02

**ID-C1012MNX, ID-C1012MNXB, ID-C1012ENX, ID-C1012ENXB,
ID-C1012CMNX, ID-C1012CMNXB, ID-C1012CENX, ID-C1012CENXB**

mm	in
0.01	0.0005
0.02	0.001
0.05	0.002
0.1	0.005
0.2	0.01
0.5	0.02

- 2** Press the [F2] key.
- » Settings of analog bar scale are confirmed; shifts to the next parameter item.
(Go to  "5.9 Selecting Switch Function" on page 60.)

Tips

When [Auto] is selected for the analog bar scale, it automatically switches to the analog bar scale when the conditions below are present.

- When peak detection runout width (TIR) displayed:
The runout width is the analog bar display entered within the analog bar display range
- When tolerance judgment function ON:
The preset value is the analog bar display entered in the analog bar display range
- When the resolution switched:
Analog bar display that is identical to the resolution

5.9 Selecting Switch Function

The function assignments when respective key ([F1] key, [F2] key, [F3] key) is short pressed (switch function).

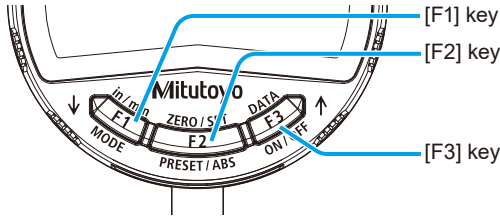

Tips

Changes can be made regardless of the measurement mode, but the changed function will be enabled only when the measurement mode is "Standard 1".

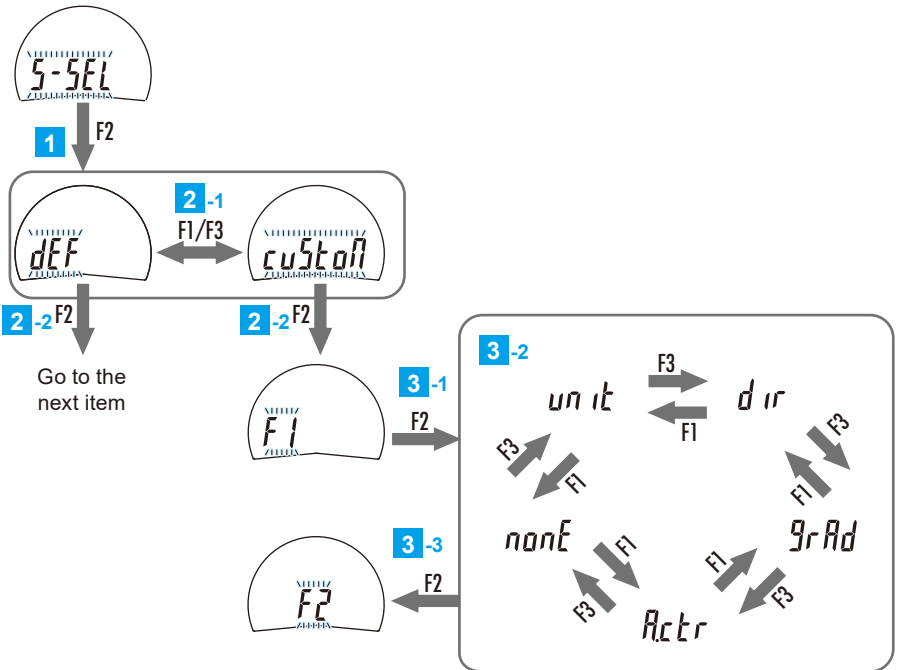

1 Press the [F2] key.

- » Switch function can be set.

2 Select the default/customized switch function.

- 1 Press the [F1] key or [F3] key.
 - » Each time the key is pressed, the default/customized switch function alternates.
- 2 Press the [F2] key.

When customize [cuStoM] is selected:

- » The function assignment of the [F1] key becomes settable, and [F1] blinks.

If default [dEF] is selected:

- » Selection is confirmed; shifts to the next parameter item.
(Go to  "5.10 Setting Function Lock" on page 64.)

3 Setting the function assigned to the [F1] key

- 1 Press the [F2] key.
 - » The function assigned to the [F1] key can be set.
- 2 Press the [F1] key or [F3] key.
 - » Each time the key is pressed, it will switch the functions in order.
- 3 Press the [F2] key.
 - » The function assignment of the [F1] key is confirmed and [F2] blinks.

4 Setting the function assigned to the [F2] key

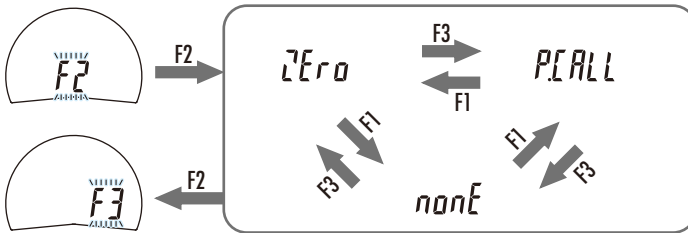

- 1 Set in the same manner as the [F1] key (step **3**).
- 2 Press the [F2] key.
 - » The function assignment of the [F2] key is confirmed and [F3] blinks.

5 Setting the function assigned to the [F3] key

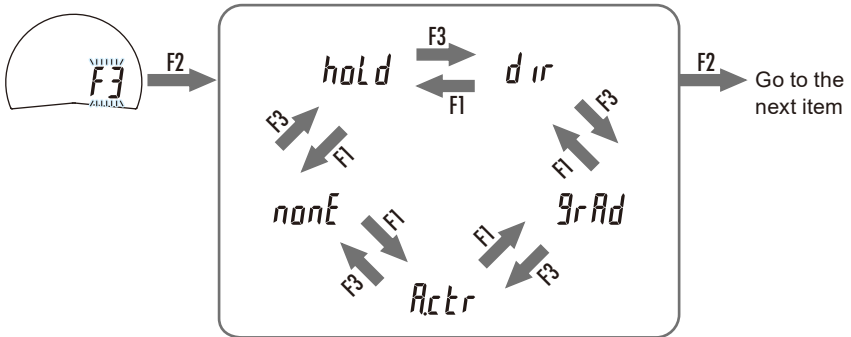

- 1 Set in the same manner as the [F1] key (step **3**).
- 2 Press the [F2] key.
 - » The function assignment of the [F3] key is confirmed; shifts to the next parameter item.
(Go to "5.10 Setting Function Lock" on page 64.)

■ Functions that can be assigned to each key

[F1] key	[F2] key	[F3] key
[nonE] None	[nonE] None	[nonE] None
[unit] Unit switching	[ZEro] Zero setting	[hoLd] Display value hold
[dir] Count direction switching	[P.CALL] Preset recall* ¹	[dir] Count direction switching
[grAd] Analog bar scale switching	—	[grAd] Analog bar scale switching
[A.ctr] Analog bar centering* ²	—	[A.ctr] Analog bar centering* ²

- *1: Set the measurement origin by replacing the display value with the preset value.
- *2: By setting the analog bar scale, move the pointer display position to the center of the scale when the pointer is out of the display range, etc.

5.10 Setting Function Lock

When function lock is executed, function lock display (🔒) will appear on the display and operations other than turning the power ON/OFF, holding/releasing the displayed value, outputting the displayed value, and canceling the Function Lock function will be disabled.



1 Press the [F2] key.

- » Function Lock function can be set.

2 Press the [F1] key or [F3] key.

- » Each time the key is pressed, the function lock turns ON/OFF alternately.

3 Press the [F2] key.

- » Settings are confirmed; shifts to the next parameter item.
(Go to 📖 "5.11 Change Other Functions" on page 65.)

Tips

- Function lock is enabled when exiting parameter setting mode and returning to measurement mode.
- To set an item for which the function has been locked, select [oFF] in step 2 and after function lock has been canceled, each setting can be changed.

5.11 Change Other Functions

5.11.1 Selecting Setting Items

There are three types of parameter items in "Change other functions".

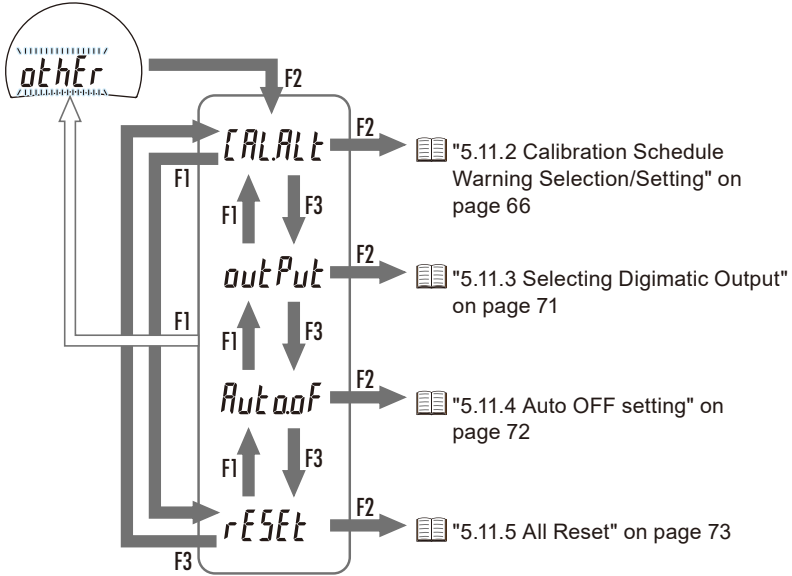

5.11.2 Calibration Schedule Warning Selection/Setting

By setting the current date, calibration date and advance warning date, the warning display (🔔) notifying the arrival of calibration schedule will be lit on the display.

Enable/disable calibration schedule warning function, current date, calibration date and advance warning date can be changed.

Tips

If the power is turned ON/OFF using the [F3] key, it is not necessary to reset the current date. However, if the battery is removed, the current date must be reset when the power is turned on again.

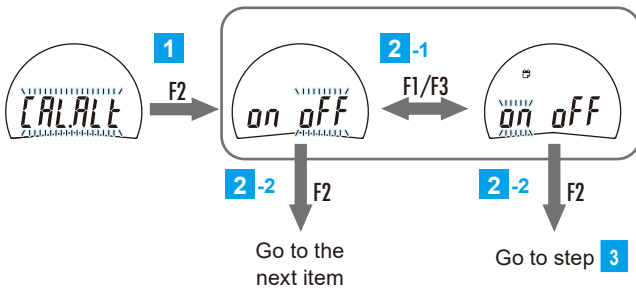

1 Press the [F2] key.

- » Calibration schedule warning can be set.

2 Select ON/OFF for the calibration schedule warning.**1** Press the [F1] key or [F3] key.

- » Each time the key is pressed, the calibration schedule warning turns ON/OFF alternately.

2 Press the [F2] key.**If [on] is selected:**

- » The current date becomes settable and [todAy] blinks.

If [oFF] is selected:

- » Selection is confirmed; shifts to the next parameter item of "Other function changes".

(Go to  "5.11.3 Selecting Digimatic Output" on page 71.)

3 Set the current date.

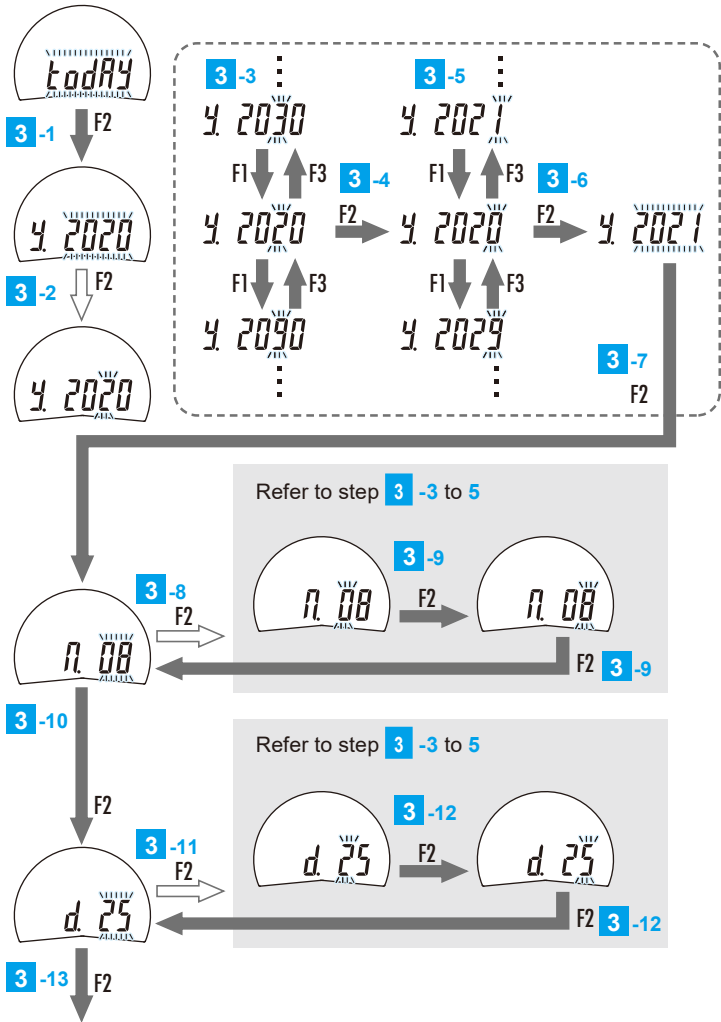

- 1** Press the [F2] key.
 - » Year display blinks.
 - » To skip the number of years setting, press the [F2] key again (shifts to **8** (number of months setting)).

Setting the number of years

- 2** Press and hold the [F2] key.
 - » Tens place of the year blinks.
- 3** Press the [F1] key or [F3] key.
 - » Each time the key is pressed, the value will change by one.
- 4** Press the [F2] key.
 - » The tens place is confirmed and the units place blinks.
- 5** Press the [F1] key or [F3] key.
 - » Each time the key is pressed, the value will change by one.
- 6** Press the [F2] key.
 - » The units place is confirmed and the year display blinks.
- 7** Press the [F2] key.
 - » Month display blinks.
 - » To skip the number of months setting, press the [F2] key again (shifts to **11** (number of days setting)).

Setting the number of months

- 8** Press and hold the [F2] key.
 - » Tens place of the month blinks.
- 9** Set the number of months in the same manner as above in **3** to **6**.
- 10** Press the [F2] key.
 - » Day display blinks.
 - » To skip the number of days setting, press the [F2] key again (shifts to step **4**).

Setting the number of days

- 11** Press and hold the [F2] key.
 - » Tens place of the day blinks.
- 12** Set the number of days in the same manner as above in **3** to **6**.
- 13** Press the [F2] key.
 - » Calibration date becomes settable and [CALib] blinks.

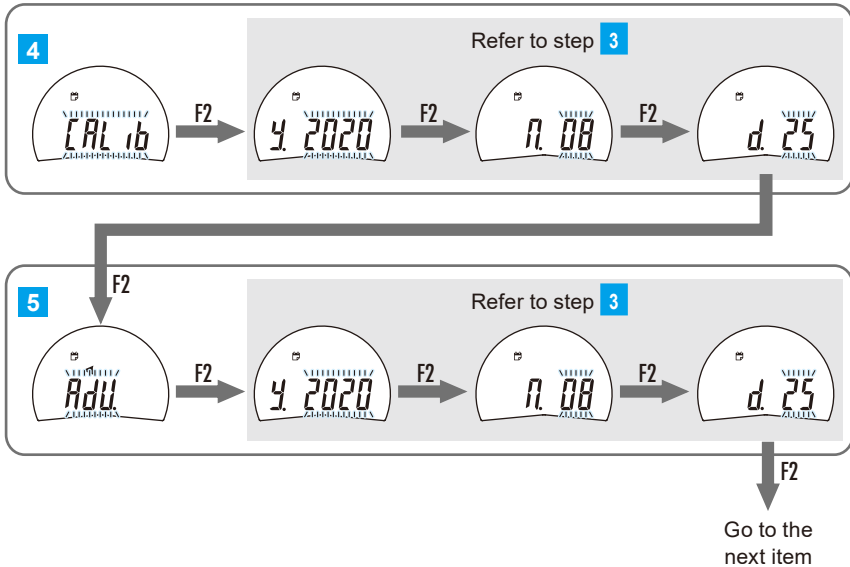

4 Set the calibration date.

- 1 Set in the same manner as the current date (step 3).
- 2 Press the [F2] key.
 - » Advance warning date becomes settable and [Adv.] blinks.

5 Set the advance warning date.

- 1 Set in the same manner as the current date (step 3).
- 2 Press the [F2] key.
 - » Setting is confirmed; shifts to the next parameter item of "Other function changes". (Go to "5.11.3 Selecting Digimatic Output" on page 71.)

Tips

If each date is set as follows, a calibration schedule setting error (Err 92) will occur.

- Calibration date < Current date
- Calibration date < Advance warning date
- Advance warning date < Current date

Press the [F2] key and reset it so that current date < advance warning date < calibration date. For details, see "8 Error Displays and Countermeasures" on page 83.

5.11.3 Selecting Digimatic Output

For the following models, the data format setting for external output of displayed values can be changed. Select from DIGIMATIC d1 (6-digit output) or DIGIMATIC d2 (8-digit output).

ID-C0512NX, ID-C0512NXB, ID-C0512MNX, ID-C0512MNXB,
ID-C0512ENX, ID-C0512ENXB, ID-C0512CNX, ID-C0512CNXB,
ID-C0512CMNX, ID-C0512CMNXB, ID-C0512CENX, ID-C0512CENXB

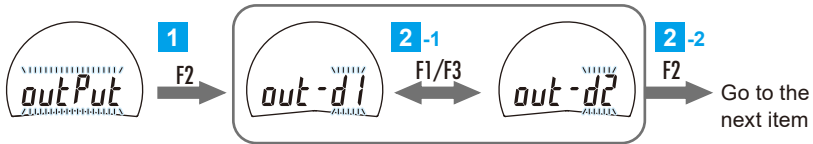

1 Press the [F2] key.

- » Digimatic output selection can be set.

2 Select the data format for digimatic output.

- 1 Press the [F1] key or [F3] key.
 - » Each time the key is pressed, it will switch between [d1] and [d2].
- 2 Press the [F2] key.
 - » Setting is confirmed; shifts to the next parameter item of "Other function changes". (Go to "5.11.4 Auto OFF setting" on page 72.)

Tips

For details about data format, see "■ Data format" on page 90.

5.11.4 Auto OFF setting

The auto OFF function ON/OFF can be set. When set to ON, if there are no changes in measured values, key operation, or output requests over 20 minutes, the power will go OFF automatically.

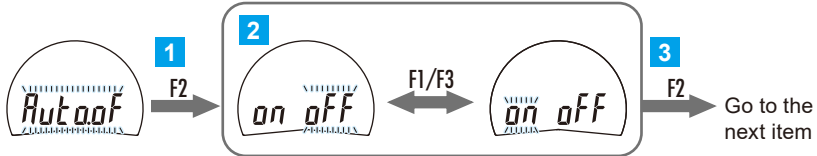

1 Press the [F2] key.

» Auto OFF setting is enabled.

2 Press the [F1] key or [F3] key.

» Each time the key is pressed, the auto OFF switches between ON and OFF.

3 Press the [F2] key.

» Settings are confirmed; shifts to the next parameter item.
(Go to  "5.11.5 All Reset" on page 73.)

Tips

- Auto OFF is enabled when exiting parameter setting mode and returning to measurement mode.
- To turn the power ON after auto OFF, press the [F2] key.
- The auto OFF function is disabled in parameter setting mode.

5.11.5 All Reset

All Reset will reset all settings of this product to default.

Tips

- Once All Reset is executed, the previous settings will not be retrievable.
- Press the [F1] key to cancel partway through. Return to the previous step.
- For the defaults for each setting, refer to "5.1 Selecting Parameter Items" on page 35.

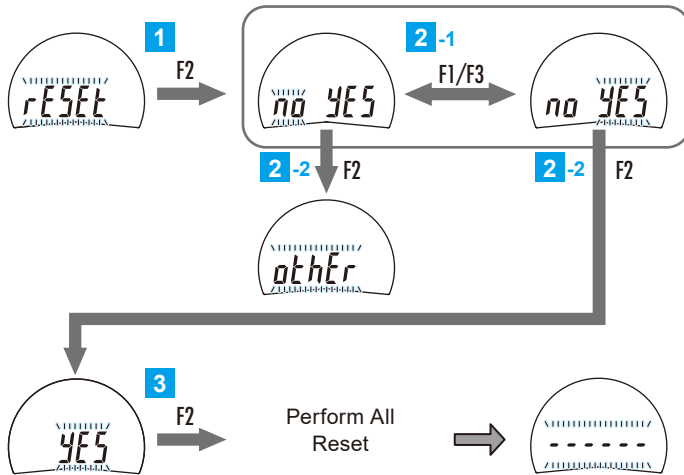

1 Press the [F2] key.

- » All Reset can be executed.

2 Select whether to perform All Reset.

- 1 Press the [F1] key or [F3] key.
 - » Each time the key is pressed, it will switch between [no] and [YES].
- 2 Press the [F2] key.
 - If [YES] is selected: Confirms execution.**
 - » [YES] blinks.
 - If [no] is selected: Stops.**
 - » All Reset is canceled and the display returns to [othEr].

3 Press the [F2] key.

- » [-----] blinks when All Reset is executed and completed.

MEMO

6 Precautions after Use

- Lightly wipe off dirt on the exterior with a lint-free soft cloth (silicone cloth, etc.).

NOTICE

If wiped with benzene, etc., or if metal polish is used, the surface may become discolored or the coating may peel off.



Do not use organic solvents such as detergents, thinner or benzene.

- Dirt on the plunger may lead to malfunction. Clean with a cloth moistened with alcohol, etc. before use.
- Do not lubricate the plunger with lubricating oil, etc.
- Do not store the product in a place with a high temperature or humidity, or a lot of dust or oil mist.

MEMO

7 Low Measuring Force Types

The following models (low measuring force type) use an aluminum plunger to reduce the weight of the movable parts.

- ID-C0512CNX, ID-C0512CNXB, ID-C0512CMNX, ID-C0512CMNXB,
- ID-C0512CENX, ID-C0512CENXB, ID-C1012CNX, ID-C1012CNXB,
- ID-C1012CMNX, ID-C1012CMNXB, ID-C1012CENX, ID-C1012CENXB



NOTICE

Although the surface of the plunger has been treated for abrasion resistance, any dirt or damage on the surface of the plunger will make accurate measurements impossible.

7.1 Changing the Measuring Force

The measuring force can be changed as shown in the table below, by adding or removing the coil spring or weight.



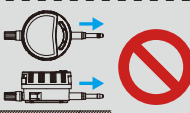
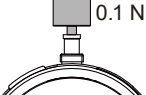
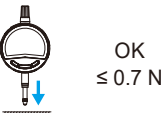
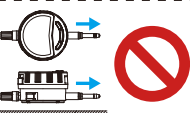
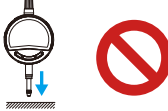
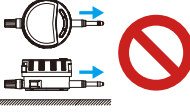
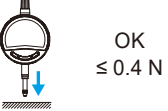
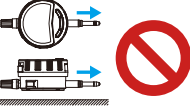

- ID-C0512CNX, ID-C0512CNXB, ID-C0512CMNX, ID-C0512CMNXB, ID-C0512CENX, ID-C0512CENXB

	No weight	Weight attached 0.1 N
Coil spring attached	  	  
No coil spring	 	 

: Factory default conditions : Not a guaranteed operation posture

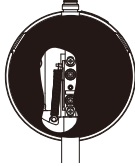
7 Low Measuring Force Types

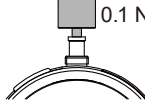
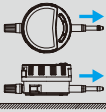
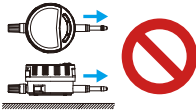
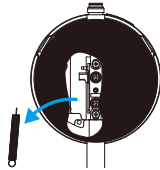
- ID-C1012CNX, ID-C1012CNXB, ID-C1012CMNX, ID-C1012CMNXB, ID-C1012CENX, ID-C1012CENXB

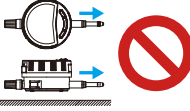
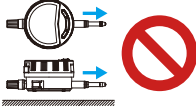
	No weight	Weight attached 0.1 N
Coil spring attached 	 OK $\leq 0.4 \text{ N}$	 OK $\leq 0.5 \text{ N}$
	 OK $\leq 0.3 \text{ N}$	
No coil spring 	 OK $\leq 0.2 \text{ N}$	 OK $\leq 0.3 \text{ N}$
		

: Factory default conditions : Not a guaranteed operation posture

Tips

- If an optional contact point or extension rod for the dial indicator is mounted, measuring force changes and operation posture will be restricted in some cases.
- Store the removed coil spring, cap, and weight to prevent loss.

7.1.1 Adding/Removing the Coil Spring

The coil spring is mounted inside the product as shown in the figure below. Use the following procedure to add or remove it.

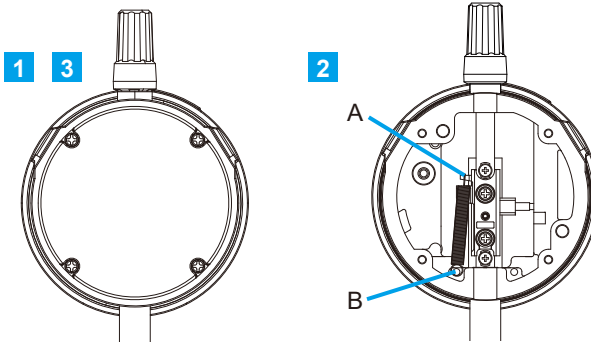

1 Remove the four screws on the back using a #0 Phillips screwdriver, and then remove the flat back.

2 Use a tool such as tweezers to pinch the coil spring hook part, and then remove the coil spring from the spring attachment hook (A) and projection (B).



Do not forcibly pull the removed coil spring by hand.

3 Place the flat back and tighten the four screws on the back using a #0 Phillips screwdriver.

7.1.2 Adding/Removing the Weight



- When adding or removing the screw on top of the plunger or the weight, make sure to insert a hex key or other tool (roughly 2 mm diameter) into the key hole on the plunger in order to protect the internal mechanism.
- The screw on top of the plunger is used to protect the internal mechanism. Make sure to attach this when not using a weight.

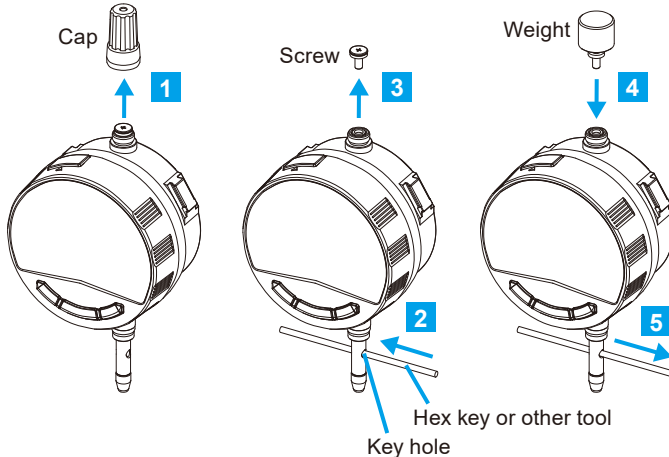

- 1** Rotate the cap counterclockwise to remove it from the product.
- 2** Insert a tool such as a hex key into the key hole in the plunger.
- 3** Use the hex key or other tool to hold the plunger in place and prevent it from twisting as you turn the screw (M2.5) on top of the plunger to remove it.
- 4** Keep holding the plunger in place as you attach a weight in place of the screw.
- 5** Remove the hex key or other tool from the key hole.

Tips

- To replace a weight with a screw, follow the above procedure in reverse.
- The cap or lifting knob (optional) cannot be mounted when using a weight.
- The lifting lever can be used together with a weight.

7.2 Contact Point Replacement



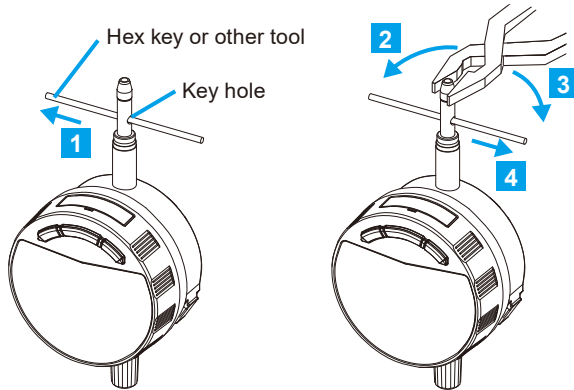

When replacing the contact point, make sure to insert a hex key or other tool (roughly 2 mm diameter) into the key hole on the plunger in order to protect the internal mechanism.







- 1** Insert a tool such as a hex key into the key hole in the plunger.
- 2** Use the hex key or other tool to hold the plunger in place and prevent it from twisting as you turn the contact point with a tool such as pliers to remove it.
- 3** Keep holding the plunger in place as you mount the replacement contact point, and then use a tool such as pliers to secure it.
- 4** Remove the hex key or other tool from the key hole.

MEMO



8 Error Displays and Countermeasures

No.	Error name	LCD display	Cause	Countermeasures
-	ABS Synthesis Error	Last digit is E. 	The sensor signal cannot be synthesized.	Although this may occur during high-speed plunger movement, there is no effect on measurement. Use the product as is. * If it occurs while the plunger is not moving, the sensor may have failed. Please contact the agent where you purchased the product or a Mitutoyo sales/service representative. (☞) "12 Off-Site Repairs (Subject to Charge)" on page 105)
-	Battery voltage decrease display		Battery voltage is low.	Replace with a new battery.
15	Low Battery Voltage Error	Err 15 	Cannot perform measurement because the battery is low.	Replace with a new battery.



8 Error Displays and Countermeasures

No.	Error name	LCD display	Cause	Countermeasures
30	Display Value Overflow Error	Err 30 	The display value exceeds the displayable range.	When the display value returns to the number of displayable digits, the error is automatically cleared. <ul style="list-style-type: none">• Reset the resolution.• Set the calculation coefficient again. ( "5.1 Selecting Parameter Items" on page 35,  "5.5 Selecting Resolution" on page 44,  "5.7 Setting Calculation Function Selection and Calculation Coefficient" on page 50)



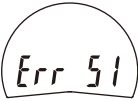

8 Error Displays and Countermeasures

No.	Error name	LCD display	Cause	Countermeasures
40	Sensor Contamination Detection Error	Err 40 	A sudden change in temperature may create condensation on the detector, or it may be contaminated by other sources.	Although this may occur during high-speed plunger movement, there is no effect on measurement. Use the product as is. <ul style="list-style-type: none"> • If it occurs while the plunger is not moving, turn the power OFF and allow the product to adapt to the temperature for about 2 hours. • If it does not recover after adapting to the temperature, repair is required. Please contact the agent where you purchased the product or a Mitutoyo sales/service representative. (☞ "12 Off-Site Repairs (Subject to Charge)" on page 105)
41	Internal Connection Error	Err 41 	There is a problem with the internal connection.	The product may be faulty. Please contact the agent where you purchased the product or a Mitutoyo sales/service representative. (☞ "12 Off-Site Repairs (Subject to Charge)" on page 105)
50	Serial Communication Forced Error	Err 50 	A serial communication command [B7] (forced error display) is received.	Send a serial communication command [B8] (error reset).



8 Error Displays and Countermeasures

No.	Error name	LCD display	Cause	Countermeasures
51	Calibration Schedule Warning Forced Error	Err 51 	A serial communication command [89] (calibration schedule warning forced display) is received.	Send a serial communication command [89] (calibration schedule warning forced display).
61	Set Value Rewrite Error	Err 61 	For some reason, the set value has been rewritten since the previous use.	Press the [F1] key to return to measurement mode, check various settings, and reset where needed.
62	Set Value Storage Error	Err 62 	Settings cannot be saved. The set values cannot be read.	<ul style="list-style-type: none"> • After turning OFF the power, turn ON the power again, check various set values, and reset where needed. • If the same error occurs even after the power is turned on again, the product may be faulty. Please contact the agent where you purchased the product or a Mitutoyo sales/service representative. (☎ "12 Off-Site Repairs (Subject to Charge)" on page 105) • If the error occurs frequently, the supply voltage may be unstable. Check the supply voltage.

8 Error Displays and Countermeasures

No.	Error name	LCD display	Cause	Countermeasures
63	Internal Program Error	Err 63 	Measurement cannot be done because of an internal program error.	The product may be faulty. Please contact the agent where you purchased the product or a Mitutoyo sales/service representative. (☞ "12 Off-Site Repairs (Subject to Charge)" on page 105)
90	Allowable Value Setting Error	Err 90 	The upper limit value is set to a value smaller than the lower limit value.	Set the upper limit value to a value greater than the lower limit value (upper limit value > lower limit value). (☞ "5.1 Selecting Parameter Items" on page 35, ☞ "5.6.2 Setting Allowable Values (Upper Limit Value and Lower Limit Value)" on page 48)
91	Calculation Coefficient Setting Error	Err 91 	The calculation coefficient is set to 0.	Reset the calculation coefficient to a value other than zero. (☞ "5.1 Selecting Parameter Items" on page 35, ☞ "5.7 Setting Calculation Function Selection and Calculation Coefficient" on page 50)
92	Calibration Date Setting Error	Err 92 	The calibration date and advance warning date are set before the current date.	Set it so that current date < advance warning date < calibration date. (☞ "5.1 Selecting Parameter Items" on page 35, ☞ "5.11.2 Calibration Schedule Warning Selection/ Setting" on page 66)

8 Error Displays and Countermeasures

No.	Error name	LCD display	Cause	Countermeasures
95	Allowable Value (Upper Limit) Overflow Error	Err 95 ▶ 	The upper limit exceeds the displayable range.	<ul style="list-style-type: none"> Reset the upper limit value. Reset the resolution. (☰ "5.1 Selecting Parameter Items" on page 35, ☰ "5.6.2 Setting Allowable Values (Upper Limit Value and Lower Limit Value)" on page 48, ☰ "5.5 Selecting Resolution" on page 44)
	Allowable Value (Lower Limit) Overflow Error	Err 95 ◀ 	The lower limit value exceeds the displayable range.	<ul style="list-style-type: none"> Reset the lower limit value. Reset the resolution. (☰ "5.1 Selecting Parameter Items" on page 35, ☰ "5.6.2 Setting Allowable Values (Upper Limit Value and Lower Limit Value)" on page 48, ☰ "5.5 Selecting Resolution" on page 44)
	Preset Value Overflow Error	Err 95 P 	The preset value exceeds the displayable range.	<ul style="list-style-type: none"> Set the preset value again. Reset the resolution. (☰ "4.1.1 Setting Origin and Preset Values" on page 22, ☰ "5.1 Selecting Parameter Items" on page 35, ☰ "5.5 Selecting Resolution" on page 44)

9 Input/Output Functions

For input/output functionality, the product has both DIGIMATIC d1/d2 (output) and DIGIMATIC S1 (input/output).

- DIGIMATIC d1: 6-digit output for Mitutoyo DIGIMATIC products
- DIGIMATIC d2: 8-digit output for Mitutoyo DIGIMATIC products
- DIGIMATIC S1: Bidirectional serial I/O for Mitutoyo DIGIMATIC products

Tips

DIGIMATIC S1 is our in-house own bidirectional serial communication. It can be obtained by connecting* to a PC with this product and Measurement data collection software USB-ITPAK V3.0 (Parts No. 06AGR543) installed.

*Please use the dedicated options (VCP driver installation required) below.

- Measurement Data Input Unit: IT-020U (Parts No. 264-020)
- Measurement Data Input Unit USB Direct Input Tool: USB-ITN-SF (Parts No. 06AGQ001F)

9.1 I/O Connector

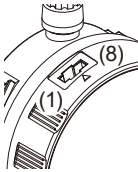

Pin No.	DIGIMATIC d1/d2	
	Signal	I/O
(1)	GND	-
(2)	DATA	O
(3)	CK	O
(4)	RD	O
(5)	REQ	I
(6)	N.C.	-
(7)	N.C.	-
(8)	N.C.	-

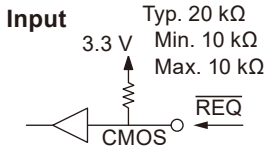

Output

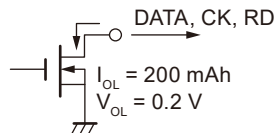

Load voltage: DC 3 to 6 V
Load current: Max. 200 mA

9.2 DIGIMATIC d1/d2 (Output)

DIGIMATIC d1/d2 output the displayed value data for the REQ signal to the external device.

■ Data format

● DIGIMATIC d1

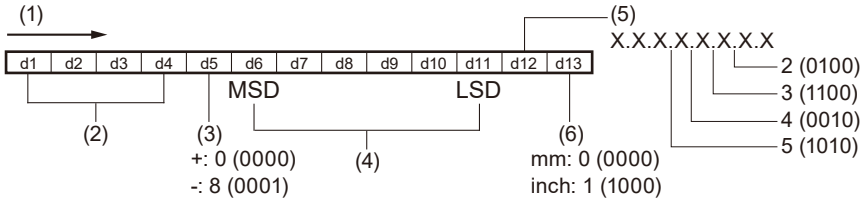

(1) Output order

Each digit: d1 → d13

Each bit within one digit:

bit0 → bit3

(2) All "F(1111)"

(3) Sign

(4) Measured value (6 digits)

(5) Decimal point

(6) Units

Example: 123.456 mm

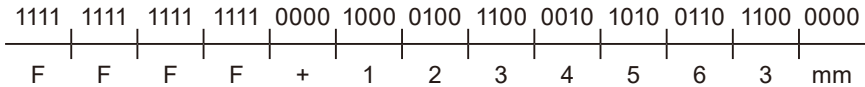

9 Input/Output Functions

● DIGIMATIC d2

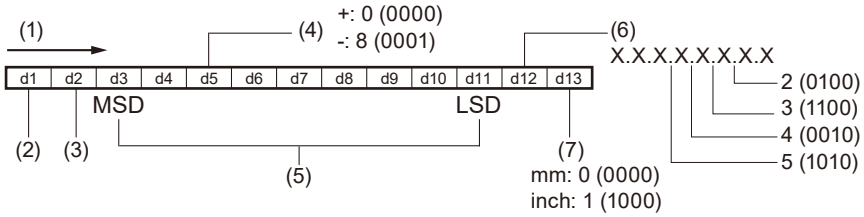

- (1) Output order
Each digit: d1 → d13
Each bit within one digit:
bit0 → bit3
- (2) Data format: 8 (0001)
- (3) F (1111)
- (4) Sign
- (5) Measured value
(8 digits: d3 to d4, d6 to d11)
- (6) Decimal point
- (7) Units

Example: -1234.5675 mm

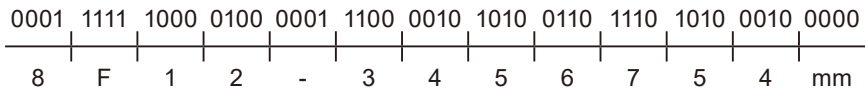

■ Timing Chart

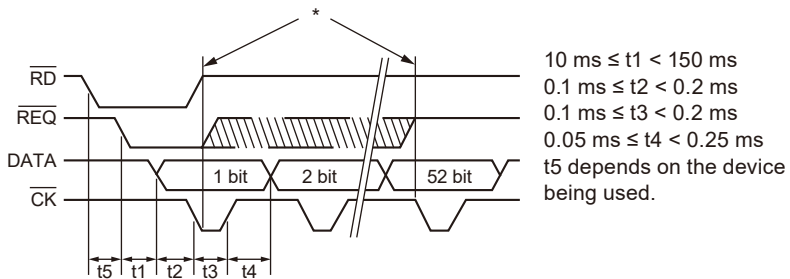

- * Keep REQ at Low until CK is output.
Return it to High before the final CK output is completed (52nd bit).

MEMO

10 Specifications

■ Specifications of standard models

Model No.		ID-C0512NX	ID-C0512NXB
Code No.		543-700	543-700B
Measuring range		12.7 mm	
Resolution		0.0005 mm	
Resolution switching		0.0005 / 0.001 / 0.01 mm	
JIS/SISO	Error of indication (MPE)	Partial measuring range P_{MPE}^{**1}	0.003 mm
		Total measuring range E_{MPE}^{**1}	0.003 mm
	Hysteresis H_{MPE}^{**1}	0.002 mm	
	Repeatability R_{MPE}^{**1}	0.002 mm	
Stem		ø8 mm	
Contact point		Carbide (M2.5 x 0.45) Part No. 901312 (standard accessory)	
Measuring force (MPL)		1.5 N or less	
Measurement direction		All directions	
Backs		With lug	Flat
Mass		175 g	165 g

10 Specifications

Model No.		ID-C0512MNX	ID-C0512MNXB	ID-C0512ENX	ID-C0512ENXB
Code No.		543-701	543-701B	543-702	543-702B
Measuring range		12.7 mm / 0.5 in			
Resolution		0.0005 mm / 0.00002 in			
Resolution switching		0.0005 / 0.001 / 0.01 mm 0.00002 / 0.00005 / 0.0001 / 0.0005 in			
JIS/ISO	Error of indication (MPE)	Partial measuring range P_{MPE}^{*1}	0.003 mm		
		Total measuring range E_{MPE}^{*1}	0.003 mm		
	Hysteresis H_{MPE}^{*1}	0.002 mm			
	Repeatability R_{MPE}^{*1}	0.002 mm			
ASME	Overall ^{*1,2}	±0.00012 in			
	Hysteresis ^{*1}	0.00008 in			
	Repeatability ^{*1}	0.00008 in			
Stem		ø8 mm		0.375 in diameter (ø9.52 mm)	
Contact point		Carbide (M2.5 x 0.45) Part No. 901312 (standard accessory)		Carbide (No. 4-48UNF) Part No. 21BZB005 (standard accessory)	
Measuring force (MPL)		1.5 N or less			
Measurement direction		All directions			
Backs		With lug	Flat	With lug	Flat
Mass		175 g	165 g	195 g	165 g

10 Specifications

Model No.		ID-C1012NX	ID-C1012NXB
Code No.		543-710	543-710B
Measuring range		12.7 mm	
Resolution		0.01 mm	
Resolution switching		-	
JIS/ISO	Error of indication (MPE)	Partial measuring range P_{MPE}^{**1}	0.02 mm
		Total measuring range E_{MPE}^{**1}	0.02 mm
	Hysteresis H_{MPE}^{**1}	0.02 mm	
	Repeatability R_{MPE}^{**1}	0.01 mm	
Stem		ø8 mm	
Contact point		Carbide (M2.5 x 0.45) Part No. 901312 (standard accessory)	
Measuring force (MPL)		0.9 N or less	
Measurement direction		All directions	
Backs		With lug	Flat
Mass		170 g	160 g

10 Specifications

Model No.		ID-C1012MNX	ID-C1012MNXB	ID-C1012ENX	ID-C1012ENXB
Code No.		543-711	543-711B	543-712	543-712B
Measuring range		12.7 mm / 0.5 in			
Resolution		0.01 mm / 0.0005 in			
Resolution switching		-			
JIS/ISO	Error of indication (MPE)	Partial measuring range P_{MPE}^{*1}	0.02 mm		
		Total measuring range E_{MPE}^{*1}	0.02 mm		
	Hysteresis H_{MPE}^{*1}	0.02 mm			
	Repeatability R_{MPE}^{*1}	0.01 mm			
ASME	Overall *1*2	±0.001 in			
	Hysteresis *1	0.001 in			
	Repeatability *1	0.0005 in			
Stem		ø8 mm		0.375 in diameter (ø9.52 mm)	
Contact point		Carbide (M2.5 x 0.45) Part No. 901312 (standard accessory)		Carbide (No. 4-48UNF) Part No. 21BZB005 (standard accessory)	
Measuring force (MPL)		0.9 N or less			
Measurement direction		All directions			
Backs		With lug	Flat	With lug	Flat
Mass		170 g	160 g	190 g	160 g

10 Specifications

■ Specifications of low measuring force model

Model No.		ID-C0512CNX	ID-C0512CNXB
Code No.		543-705	543-705B
Measuring range		12.7 mm	
Resolution		0.0005 mm	
Resolution switching		0.0005 / 0.001 / 0.01 mm	
JIS/ISO	Error of indication (MPE)	Partial measuring range P_{MPE}^{*1}	0.003 mm
		Total measuring range E_{MPE}^{*1}	0.003 mm
	Hysteresis H_{MPE}^{*1}	0.002 mm	
	Repeatability R_{MPE}^{*1}	0.002 mm	
Stem		ø8 mm	
Contact point		Carbide (M2.5 x 0.45) Part No. 901312 (standard accessory)	
Measuring force (MPL)		Refer to "7 Low Measuring Force Types" on page 77	
Measurement direction		Refer to "7 Low Measuring Force Types" on page 77	
Backs		With lug	Flat
Mass		170 g	160 g

10 Specifications

Model No.		ID-C0512CMNX	ID-C0512CMNXB	ID-C0512CENX	ID-C0512CENXB
Code No.		543-706	543-706B	543-707	543-707B
Measuring range		12.7 mm / 0.5 in			
Resolution		0.0005 mm / 0.00002 in			
Resolution switching		0.0005 / 0.001 / 0.01 mm 0.00002 / 0.00005 / 0.0001 / 0.0005 in			
JIS/ISO	Error of indication (MPE)	Partial measuring range P_{MPE}^{*1}	0.003 mm		
		Total measuring range E_{MPE}^{*1}	0.003 mm		
	Hysteresis H_{MPE}^{*1}	0.002 mm			
	Repeatability R_{MPE}^{*1}	0.002 mm			
ASME	Overall *1*2	±0.00012 in			
	Hysteresis *1	0.00008 in			
	Repeatability *1	0.00008 in			
Stem		ø8 mm		0.375 in diameter (ø9.52 mm)	
Contact point		Carbide (M2.5 x 0.45) Part No. 901312 (standard accessory)		Carbide (No. 4-48UNF) Part No. 21BZB005 (standard accessory)	
Measuring force (MPL)		Refer to "7 Low Measuring Force Types" on page 77			
Measurement direction		Refer to "7 Low Measuring Force Types" on page 77			
Backs		With lug	Flat	With lug	Flat
Mass		170 g	160 g	190 g	160 g

10 Specifications

Model No.		ID-C1012CNX	ID-C1012CNXB
Code No.		543-715	543-715B
Measuring range		12.7 mm	
Resolution		0.01 mm	
Resolution switching		-	
JIS/ISO	Error of indication (MPE)	Partial measuring range P_{MPE}^{**1}	0.02 mm
		Total measuring range E_{MPE}^{**1}	0.02 mm
	Hysteresis H_{MPE}^{**1}	0.02 mm	
	Repeatability R_{MPE}^{**1}	0.01 mm	
Stem		ø8 mm	
Contact point		Carbide (M2.5 x 0.45) Part No. 901312 (standard accessory)	
Measuring force (MPL)		Refer to "7 Low Measuring Force Types" on page 77	
Measurement direction		Refer to "7 Low Measuring Force Types" on page 77	
Backs		With lug	Flat
Mass		165 g	155 g

10 Specifications

Model No.		ID-C1012CMNX	ID-C1012CMNXB	ID-C1012CENX	ID-C1012CENXB
Code No.		543-716	543-716B	543-717	543-717B
Measuring range		12.7 mm / 0.5 in			
Resolution		0.01 mm / 0.0005 in			
Resolution switching		-			
JIS/ISO	Error of indication (MPE)	Partial measuring range P_{MPE}^{*1}	0.02 mm		
		Total measuring range E_{MPE}^{*1}	0.02 mm		
	Hysteresis H_{MPE}^{*1}	0.02 mm			
	Repeatability R_{MPE}^{*1}	0.01 mm			
ASME	Overall *1*2	±0.001 in			
	Hysteresis *1	0.001 in			
	Repeatability *1	0.0005 in			
Stem		ø8 mm	0.375 in diameter (ø9.52 mm)		
Contact point		Carbide (M2.5 x 0.45) Part No. 901312 (standard accessory)	Carbide (No. 4-48UNF) Part No. 21BZB005 (standard accessory)		
Measuring force (MPL)		Refer to "7 Low Measuring Force Types" on page 77			
Measurement direction		Refer to "7 Low Measuring Force Types" on page 77			
Backs		With lug	Flat	With lug	Flat
Mass		165 g	155 g	185 g	155 g

10 Specifications

■ Common specifications

Protection level *3	IP42 *4
CE marking / UKCA marking	EMC Directive / Electromagnetic Compatibility Regulations: EN IEC 61326-1 Immunity test requirement: Clause 6.2 table 2 Emission limit: Class B RoHS Directive / The Restriction of the Use of Certain Hazardous Substances in Electrical and Electronic Equipment Regulations: EN IEC 63000
Power supply	Lithium metal battery CR2032 (3.0 V)
Battery life *5	Normal use: Approx. 2.5 years, Continuous use: Approx. 2,700 hours
Scale	Electrostatic capacitance type absolute linear encoder
Response speed	Unlimited
Display of 7 segments	11 mm
Display of analog bar	±20 scale
Display rotate	330°
Functions	Zero set, Preset, Peak detection *6, Counting direction switching, Tolerance judgment, Simple calculation, Key customize, Function lock, Auto OFF, Calibration schedule warning display, Battery voltage decrease display, Error warning display, Unit system switching *7
Data output	DIGIMATIC d1, DIGIMATIC d2
I / O	DIGIMATIC S1
Temperature range	Operation: 0 °C – 40 °C, Storage: -10 °C – 60 °C
Standard accessories	User's manual with warranty, Certificate of inspection, Lithium metal battery CR2032, Battery holder opener (Part No. 21EAB049), Weight *8

*1: During normal measurement at 20 °C.

*2: Overall magnification and linearity

*3: The protection level (IP: International Protection) is based on IEC 60529 / JIS C0920.

*4: Values are for factory conditions.

*5: The battery life varies depending on usage times and conditions. The above values are guidelines.

*6: The peak detection speed is 50 times / s.

*7: in / mm models only

*8: Low measuring force model only

MEMO

11 Accessories (Optional)

- Lifting lever: Part No. 21EZA198
- Lifting knob: Part No. 21EZA105
- Release (without auto-stop): Part No. 21JZA295
- Connection cable: Part No. 06AGL011 (1 m, flat straight)
- Connection cable: Part No. 06AGL021 (2 m, flat straight)

*For accessories (optional) other than the above, refer to the Measuring Instruments Catalog.

MEMO

12 Off-Site Repairs (Subject to Charge)

Off-site repair (subject to charge) is required in the case of the following malfunctions. Please contact the agent where you purchased the product or a Mitutoyo sales/service representative.

- Poor plunger operation
- Poor accuracy
- [E] is displayed as the last digit when the plunger is stationary
- Abnormal measured value or LCD trouble
- No recovery from [Err 40]
- No recovery from [Err 41]
- No recovery from [Err 63]
- Power will not turn on

*If the fundamental structural components or multiple components need to be replaced, we reserve the right to decline the repair.

MEMO

SERVICE NETWORK

Please refer to the URL below.

<https://www.mitutoyo.co.jp/eng/corporate/network/overseas/index.html>

Mitutoyo Corporation

20-1, Sakado 1-Chome, Takatsu-ku, Kawasaki-shi, Kanagawa 213-8533, Japan

Tel: +81 (0)44 813-8230 Fax: +81 (0)44 813-8231

Home page: <https://www.mitutoyo.co.jp/global.html>

For the EU Directive, Authorized representative and importer in the EU:

Mitutoyo Europe GmbH

Borsigstrasse 8-10, 41469 Neuss, Germany

For the UK Regulation, Authorized representative and importer in the UK:

Mitutoyo (UK) Ltd.

Joule Road, West Point Business Park, Andover, Hampshire SP10 3UX,
UNITED KINGDOM