

**Mitutoyo**

# Linear Gage Counter EH Series

**EH-101P**

**EH-102P**

**EH-102Z**

**EH-102S**

**EH-102D**

## **User's Manual** **- Instructions for use -**

Read this User's Manual thoroughly before operating the instrument. After reading, retain it close at hand for future reference.

This English language version of the User's Manual contains the original instructions.

No. 99MBC109B6

Date of publication: January 1, 2024 (1)



---

## ■ Product names and model numbers

Product name	Model number
Linear Gage Counter EH Series	EH-101P
	EH-102P
	EH-102Z
	EH-102S
	EH-102D

## ■ Notice regarding this document

- Mitutoyo Corporation assumes no responsibilities for any damage to the instrument, caused by its use not conforming to the procedure described in this document.
- Upon loan or transfer of this instrument, be sure to attach this document to the product.
- In the event of loss or damage to this document, immediately contact a Mitutoyo sales office or your dealer.
- Before operation of the product, thoroughly read this document to comprehend its contents.
- Particularly, for full understanding of information, carefully read "Safety Precautions" and "Precautions for Use" at the outset of this manual before using the product.
- The contents in this document are based on the information current as of January, 2024.
- No part or whole of this document may be transmitted or reproduced by any means without prior written permission of Mitutoyo Corporation.
- Some screen displays in this document may be highlighted, simplified or partially omitted for convenience of explanation. In addition, some of them may differ from actual ones to the extent that no user will misunderstand the functions and operations.
- The corporation, organization and product names that appear in this manual are their trademarks or registered trademarks.





© 2017-2024 Mitutoyo Corporation. All rights reserved.

---



## CONVENTIONS USED IN THIS DOCUMENT

Conventions used in Mitutoyo's User's Manual are roughly divided into three types (safety reminders, prohibited and mandatory actions, and referential information and locations). Moreover, these conventions include general warnings and specific warnings. Specific warning symbols are provided with concrete pictograms inside of them.

### ■ Safety reminder conventions and wording warning against potential hazards

	Indicates an immediately hazardous situation which, if not avoided, will result in serious injury or death.
	Indicates a potentially hazardous situation which, if not avoided, could result in serious injury or death.
	Indicates a potentially hazardous situation which, if not avoided, may result in minor injury.
	Indicates a potentially hazardous situation which, if not avoided, may result in property damage.
	Alerts the user to a specific hazardous situation that means "Caution, risk of electric shock".

### ■ Conventions and wording indicating prohibited and mandatory actions

	Indicates concrete information about prohibited actions.
	Indicates concrete information about mandatory actions.
	Indicates that grounding needs to be implemented.

### ■ Conventions and wording indicating referential information or referential locations

**Tips** Indicates referential information such as that for when the operating methods and procedures which are printed in these sentences are to be applied to specific conditions.



Indicates referential locations if there is information that should be referred to in this document or an extraneous manual.

Example: For details about xxx, see  "1.3 Part Names and Functions" (page 2).

---

## Safety Precautions

Read these "Safety Precautions" thoroughly before operating the product to use it properly. These safety precautions include such information as to prevent an injury to the operator and other persons or damage to property. Be sure to observe the precautions.

### **WARNING**

Do not remove the cover or disassemble the product. Otherwise you may be subject to electric shock, and there is a risk of breakage or fire due to a short circuit caused by metallic powders that have gotten inside the product.

## Precautions for Use

### ■ Product applications and handling

#### ● This product is a Counter.

Do not use this product for any purposes other than as a Counter.

#### ● This is an industrial product.

Do not use this product for any purposes other than industrial applications.

#### ● This product is precision equipment.

Handle this product with care. Be careful not to apply excessive shock or force to any of the parts during operation.

---

## ■ Installation environment

This product is designed for indoor use. To ensure optimal performance for this precision equipment, take the following conditions into account when installing this product.

- **Vibration**  
Install this product in an environment where it will be subject to minimal vibration. Using this product in a place with significant vibration for an extended period of time may result in malfunction of the precision components. If using this product in a place with significant vibration is unavoidable, lay a vibration-proof rubber sheet, etc., under this product in order to reduce the vibration.
- **Dust**  
Dust in the installation site negatively affects the electrical components in the Display. Install this product in an environment where it will be subject to minimal dust.
- **Sunlight**  
If this product is exposed to direct sunlight, the heat will cause deformations in the main body, negatively affecting its operation. If installing this product in an environment that is exposed to direct sunlight, such as near a window, is unavoidable, protect it from the sunlight by curtaining it off, etc.
- **Ambient temperature, humidity**  
Use this product in a place where the ambient temperature is within the range of 0°C to 40 °C. Avoid using it in a place that is subject to sudden changes in temperature or humidity.

When using this product in the following environments, take necessary shielding measures.

- In locations subject to electric noise, such as from static electricity
- In locations subject to strong electric fields
- In locations near power supply lines/power lines
- In locations where it may directly exposed to chips, cutting fluids, water, etc.
- In locations that may be exposed to radiation
- In locations that may be exposed to corrosive gas

## ■ Maintenance

Gently wipe dirt off of the product with a soft, tightly woven cloth. If dirt is difficult to remove, wipe the dirt off with a cloth soaked in a neutral detergent, and then gently wipe the product with a dry cloth or a cloth that is tightly wrung after being soaked in water. Do not use organic solvents such as thinner or benzene.

## ■ Power source

- Turn off the power switch after use.
- Use only a power source for this product that is rated at 12 V to 24 V and an output current of 1 A or more. Never use this power source with other electric equipment that runs at a high voltage and/or large current.
- Do not connect the AC adapter to a high-current power used by machine tools or large CNC measuring instrument.

---

## Electromagnetic Compatibility (EMC)

This product complies with the EMC Directive and the UK Electromagnetic Compatibility Regulations; however, if this receives electromagnetic interference that exceeds these requirements, it will be out of warranty and require appropriate measures.

## Export Control Compliance

This product falls into the Catch-All-Controlled Goods and/or Catch-All-Controlled Technologies (including Programs) under Category 16 of Appended Table 1 of the Export Trade Control Order or under Category 16 of the Appended Table of Foreign Exchange Control Order, based on the Foreign Exchange and Foreign Trade Act of Japan.

If you intend re-export of the product from a country other than Japan, re-sale of the product in a country other than Japan, or re-provision of the technology (including program), you are obligated to observe the regulations of your country.

Also, if an option is added or modified to add a function to this product, this product may fall under the category of List-Control Goods and/or List-Control Technology (including Programs) under Category 1 - 15 of Appended Table 1 of the Export Trade Control Order or under Category 1 - 15 of the Appended Table of Foreign Exchange Control Order, based on Foreign Exchange and Foreign Trade Act of Japan. In that case, if you intend re-export of the product from a country other than Japan, re-sale of the product in a country other than Japan, or re-provision of the technology (including program), you are obligated to observe the regulations of your country. Please contact Mitutoyo in advance.

## Notes on Export to European Countries

When you intend exporting of this product to any of the European countries, it may be required to provide User's Manual(s) in English and Declaration of Conformity in English (in some cases, the official language of the country to be exported). For detailed information, please contact Mitutoyo in advance.

## Disposal of Products outside the European Countries

Please follow the official instruction in each community and country.

## Disposal of Old Electrical & Electronic Equipment (Applicable in the European Countries with Separate Collection Systems)



This symbol on the product or on its packaging is based on WEEE Directive (Directive on Waste Electrical and Electronic Equipment), and this symbol indicates that this product shall not be treated as household waste.

To reduce the environmental impact and minimize the volume of landfills, please cooperate in reuse and recycle.

For how to dispose of the product, please contact your dealer or the nearest Mitutoyo sales office.

## China RoHS Compliance Information

This product meets China RoHS requirements. See the table below.

产品中有害物质的名称及含量

部件名称	有害物质					
	铅	汞	镉	六价铬	多溴联苯	多溴二苯醚
	(Pb)	(Hg)	(Cd)	(Cr(VI))	(PBB)	(PBDE)
本体	×	○	○	○	○	○
配件	○	○	○	○	○	○

本表格依据 SJ/T 11364 的规定编制。

○: 表示该有害物质在该部件所有均质材料中的含量均在 GB/T 26572 规定的限量要求以下。

×: 表示该有害物质至少在该部件的某一均质材料中的含量超出 GB/T 26572 规定的限量要求。



环保使用期限标识是根据《电器电子产品有害物质限制使用管理办法》以及《电子电气产品有害物质限制使用标识要求(SJ/T11364-2014)》制定的,适用于中国境内销售的电子电气产品的标识。

电器电子产品只要按照安全及使用说明内容在正常使用情况下,从生产日期算起,在此期限内产品中含有的有毒有害物质不致发生外泄或突变,不致对环境造成严重污染或对其人身、财产造成严重损害。

产品使用后,要废弃在环保使用年限内或者刚到年限的产品,请根据国家标准采取适当的方法进行处置。

另外,此期限不同于质量/功能的保证期限。

---

## Warranty

In the event that this product should prove defective in workmanship or material, within one year from the date of original purchase for use, it will be repaired or replaced, at Mitutoyo's option, free of charge upon its prepaid return to Mitutoyo, without prejudice to the provisions of the Mitutoyo Software End User License Agreement.

If this product fails or is damaged for any of the following reasons, it will be subject to a repair charge, even if it is still under warranty.

- Failure or damage owing to fair wear and tear.
- Failure or damage owing to inappropriate handling, maintenance, or repair, or to unauthorized modification.
- Failure or damage owing to transport, dropping, or relocation of the product after purchase.
- Failure or damage owing to fire, salt, gas, abnormal voltage, lightning surge, or natural disaster.
- Failure or damage owing to use in combination with hardware or software other than that designated or permitted by Mitutoyo.
- Failure or damage owing to use in ultra-hazardous activities.

This warranty is effective only where the instrument is properly installed and operated in conformance with the instructions in this document within the original country of the installation.

EXCEPT AS SPECIFIED IN THIS WARRANTY, ALL EXPRESS OR IMPLIED CONDITIONS, REPRESENTATIONS, AND WARRANTIES OF ANY NATURE WHATSOEVER INCLUDING, WITHOUT LIMITATION, ANY IMPLIED WARRANTY OF MERCHANTABILITY, FITNESS FOR A PARTICULAR PURPOSE, NONINFRINGEMENT OR WARRANTY ARISING FROM A COURSE OF DEALING, USAGE, OR TRADE PRACTICE, ARE HEREBY EXCLUDED TO THE MAXIMUM EXTENT ALLOWED BY APPLICABLE LAW.

You assume all responsibility for all results arising out of its selection of this product to achieve its intended results.



---

## Disclaimer

IN NO EVENT WILL MITUTOYO, ITS AFFILIATED AND RELATED COMPANIES AND SUPPLIERS BE LIABLE FOR ANY LOST REVENUE, PROFIT, OR DATA, OR FOR SPECIAL, DIRECT, INDIRECT, CONSEQUENTIAL, INCIDENTAL, OR PUNITIVE DAMAGES HOWEVER CAUSED AND REGARDLESS OF THE THEORY OF LIABILITY ARISING OUT OF THE USE OF OR INABILITY TO USE THIS PRODUCT EVEN IF MITUTOYO OR ITS AFFILIATED AND RELATED COMPANIES AND/OR SUPPLIERS HAVE BEEN ADVISED OF THE POSSIBILITY OF SUCH DAMAGES.

If, notwithstanding the foregoing, Mitutoyo is found to be liable to you for any damage or loss which arises out of or is in any way connected with use of this product by you, in no event shall Mitutoyo's and/or its affiliated and related companies' and suppliers' liability to you, whether in contract, tort (including negligence), or otherwise, exceed the price paid by you for the product only.

The foregoing limitations shall apply even if the above-stated warranty fails of its essential purpose.

BECAUSE SOME COUNTRIES, STATES OR JURISDICTIONS DO NOT ALLOW THE EXCLUSION OR THE LIMITATION OF LIABILITY FOR CONSEQUENTIAL OR INCIDENTAL DAMAGES, IN SUCH COUNTRIES, STATES OR JURISDICTIONS, MITUTOYO'S LIABILITY SHALL BE LIMITED TO THE EXTENT PERMITTED BY LAW.

---

## About This Document

### ■ Positioning of this document in document map

In addition to this document, a User's Manual for SENSORPAK that is installed and used on a PC, and a User's Manual for each Linear Gage that is connected to and used with this product are available.

#### ● Manuals for Counters

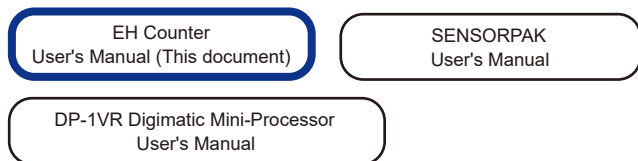

#### ● Manuals for Linear Gages

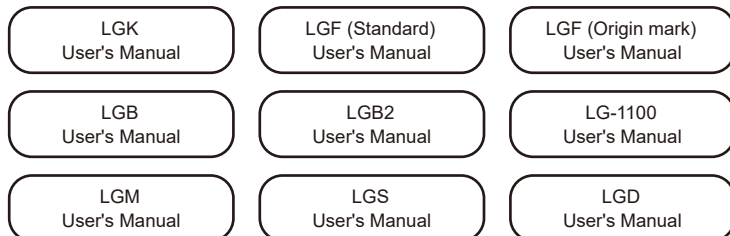

### ■ Intended readers and purpose of this document

#### ● Intended readers

This manual is intended for beginners of the EH-series counters.

Readers are assumed to be familiar with the basic operations of a PC and Windows.

They are also assumed to be able to understand instructions by reading technical drawings.

#### ● Purpose

The purpose of this document is to help you understand how to use EH-series counters.

---

## ■ How to read this document

### ● When you do not know the appropriate operation while using this product

Look for the page with the desired operation in the table of contents.

### ● To measure

The setup of this product and the settings of parameters are required in advance.

See the following pages for basic measurements, such as height measurement.

 "1 Overview" (page 1) to  "3.2 Basic Parameters" (page 12)

In addition to the pages above, see the following pages for applied measurements, such as thickness measurement using 2-axis models.

 "3.3 Advanced Parameters" (page 14) to  "3.5 CEL-Specific Parameters" (page 21)

### ● Operation key names

Operation key names are written side-by-side in the following way when an operation key name differs between 1-axis models and 2-axis models: [Key name for 2-axis models]/[Key name for 1-axis models].

### ● Terms and definitions

- INPUT A/INPUT B: Linear Gages connected to the Linear Gage input connectors A/B
- Internal counter (CEL): The 4 internal counters that 2-axis models have (CEL1 to CEL4)
- BANK: On 2-axis models, a display capable of being switched between 2 types (BANK1 and BANK2). BANK1 displays CEL1 and CEL2, BANK2 displays CEL3 and CEL4.
- UNIT: The 6 counting methods that can be displayed on each CEL

## Tips

For details about BANK, CEL, and UNIT, see  "3.4.1 Internal Structure of the Counter" (page 17).

---

## Contents

<b>CONVENTIONS USED IN THIS DOCUMENT</b> .....	<b>i</b>
<b>Safety Precautions</b> .....	<b>ii</b>
<b>Precautions for Use</b> .....	<b>ii</b>
<b>Electromagnetic Compatibility (EMC)</b> .....	<b>iv</b>
<b>Export Control Compliance</b> .....	<b>iv</b>
<b>Notes on Export to European Countries</b> .....	<b>iv</b>
<b>Disposal of Products outside the European Countries</b> .....	<b>iv</b>
<b>Disposal of Old Electrical &amp; Electronic Equipment (Applicable in the European Countries with Separate Collection Systems)</b> .....	<b>v</b>
<b>China RoHS Compliance Information</b> .....	<b>v</b>
<b>Warranty</b> .....	<b>vi</b>
<b>Disclaimer</b> .....	<b>vii</b>
<b>About This Document</b> .....	<b>viii</b>
<b>Contents</b> .....	<b>x</b>
<b>1 Overview</b> .....	<b>1</b>
1.1 Major Functions .....	1
1.2 Supported Linear Gages .....	1
1.3 Part Names and Functions .....	2
1.4 Operation Flow .....	5
<b>2 Setup</b> .....	<b>7</b>
2.1 Unpacking .....	7
2.2 Mounting .....	7
2.3 Connections .....	8
2.4 Operation Check .....	10
<b>3 Setting Parameters</b> .....	<b>11</b>
3.1 Procedure for Setting Parameters .....	11
3.2 Basic Parameters .....	12
3.3 Advanced Parameters .....	14
3.4 Details of Display Mode (2-axis Models Only) .....	17

3.5	CEL-Specific Parameters .....	21
3.6	Overview of Setting Parameters .....	22
4	Basic Operations .....	25
4.1	Switching Between Display A and B (2-Axis Models Only).....	25
4.2	Switching the Displayed BANK (2-Axis Models Only) .....	25
4.3	Zero Setting .....	26
4.4	Preset .....	27
4.5	Peak Mode Setting .....	28
4.6	Tolerance Value Setting .....	29
4.7	Optional Constant Value Setting .....	32
4.8	Registering, Reading Out, and Clearing the Memory .....	34
5	External Input/Output Function .....	35
5.1	Digimatic Output Function .....	35
5.2	USB Communication Function .....	35
5.3	RS-232C Communication Function .....	36
5.4	RS LINK Function .....	40
5.5	I/O Connector Terminal Function .....	42
6	Troubleshooting .....	49
6.1	Troubleshooting .....	49
6.2	Error Messages .....	50
7	Specifications .....	53
7.1	Basic Specifications .....	53
7.2	External Dimensions Drawing (For All Models) .....	54
7.3	Option .....	54

**SERVICE NETWORK .....** App-1



# 1 Overview

This section describes the features and part names of this product.

## 1.1 Major Functions

This product is a Counter that displays the counter values from connected Mitutoyo Linear Gages.

In addition, the following functions are available.

- Functions common to 2-axis models and 1-axis models
  - Zero Setting, Preset, Tolerance Judgment
  - Communication with a PC or external devices via RS-232C, USB, or I/O connector
  - Simple printing by connecting to a Mitutoyo Digimatic Mini-Processor
  - Multi-point measurement by connecting up to 10 Mitutoyo Counters that have the RS LINK function
- Functions unique to 2-axis models
  - 2-axis independent Counter display, and a Sum/Difference calculation display between the 2 axes

## 1.2 Supported Linear Gages

The following table shows the Linear Gages supported by this product and their features:

Model No.	Number of axes	Supported Linear Gages	Feature
EH-102P	2 axes	LGF-L-B, LGK, LGB, LGB2, LG, LGM, etc.	<ul style="list-style-type: none"> <li>• Differential square-wave output type</li> <li>• High resolution down to 0.1 <math>\mu\text{m}</math></li> <li>• High-speed response of 1.5 m/s (LGF)</li> </ul>
EH-101P	1 axis		
EH-102Z	2 axes	LGF-ZL-B, etc.	<ul style="list-style-type: none"> <li>• Scale reference-point signal output type (The origin can be restored even if the power switch is turned off)</li> </ul>
EH-102S		LGB-S, LGB2-S, etc.	<ul style="list-style-type: none"> <li>• Sine-wave output type</li> <li>• Resolution can be set according to the Counter</li> </ul>
EH-102D		LGD, LGS-1012P, etc. (ID and SD are also supported)	<ul style="list-style-type: none"> <li>• Digimatic output type</li> <li>• ABS function (no need for master setting)</li> </ul>

## 1.3 Part Names and Functions

### 1.3.1 Front Side of the Main Body

EH-102P/EH-102Z/EH-102S/EH-102D  
(2-axis model)

EH-101P  
(1-axis model)

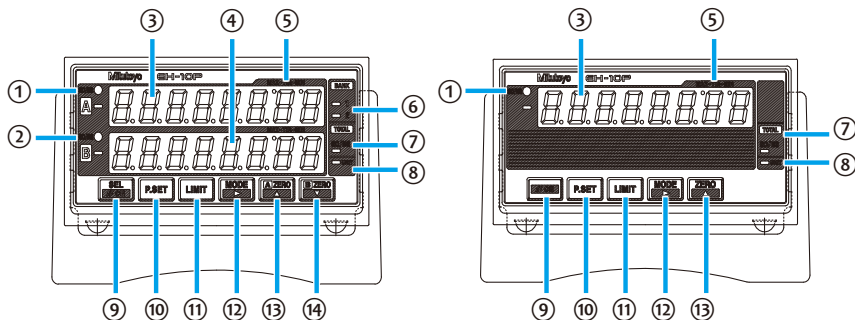

Symbol	Name	Description
①	Tolerance judgment indicator A	Indicates the tolerance judgment result of the Linear Gage (INPUT A) connected to the Linear Gage input connector A by color.
②	Tolerance judgment indicator B	Indicates the tolerance judgment result of the Linear Gage (INPUT B) connected to the Linear Gage input connector B by color.
③	Display A	Displays the counter value from INPUT A.
④	Display B	Displays the counter value from INPUT B.
⑤	Peak mode indicator	Indicates the Peak-mode type.
⑥	BANK indicator	Indicates the currently selected BANK number. For details about BANK, see  "4.2 Switching the Displayed BANK (2-Axis Models Only)" (page 25).
⑦	Total Judgment indicator	Indicates the result of the total tolerance judgment by color.



## 1 Overview

Symbol	Name	Description
⑧	UNIT indicator	<ul style="list-style-type: none"><li>• Blinks while a HOLD signal is being input when the I/O connector is connected.</li><li>• Lights when an E unit has been selected for the corresponding parameter.</li></ul>
⑨	[SEL]/[CE] key	<ul style="list-style-type: none"><li>• Cancels an operation or an error.</li><li>• Selects Display A or B.</li></ul>
⑩	[P.SET] key	Sets a Preset value. <b>Tips</b> When setting parameters, this selects the parameter number.
⑪	[LIMIT] key	Sets the tolerance value.
⑫	[MODE] key	Sets Peak mode. <b>Tips</b> When setting the tolerance, Preset, or optional constant value, this moves the current input digit from left to right.
⑬	[A_ZERO]/[ZERO] key	Sets the current value in Display A to 0. <b>Tips</b> <ul style="list-style-type: none"><li>• When setting a parameter, this advances the set value.</li><li>• When setting the tolerance, Preset, or optional constant value, this increases the value of the selected digit.</li></ul>
⑭	[B_ZERO] key	Sets the current value in Display B to 0. <b>Tips</b> When setting the tolerance, Preset, or optional constant value, this decreases the value of the selected digit.

## 1.3.2 Rear Side of the Main Body

EH-102P (2-axis model)

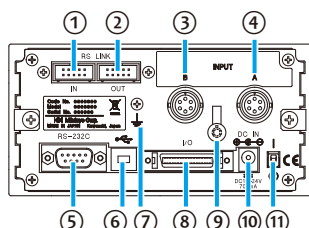

EH-101P (1-axis model)

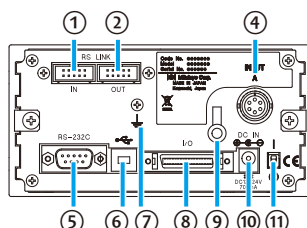

EH-102Z

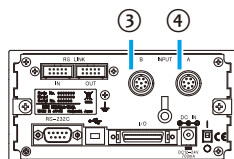

EH-102S

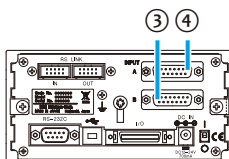

EH-102D

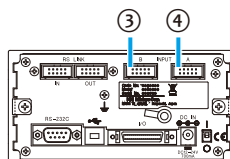
**Tips**

The shape and position of the Linear Gage input connectors differ by model.

Symbol	Name	Description
①	RS_LINK connector (IN)	For connecting an RS LINK connection cable. Also used for the SENSORPAK dongle.
②	RS_LINK connector (OUT)	For connecting an RS LINK connection cable. Also used for Digimatic output.
③	Linear Gage input connector B	For connecting a Linear Gage. The Linear Gage connected to this is referred to as INPUT B.
④	Linear Gage input connector A	For connecting a Linear Gage. The Linear Gage connected to this is referred to as INPUT A.
⑤	RS-232C connector	For connecting an RS-232C connecting cable.
⑥	USB connector	For connecting a USB connecting cable.
⑦	Grounding terminal	For connecting a grounding wire.
⑧	I/O connector	For connecting an I/O connecting cable.
⑨	Cable clamp	For securing the power cable.
⑩	DC jack	For connecting the AC adapter.
⑪	Power switch	For turning the power on and off.

## 1.4 Operation Flow

The basic operation flow is explained below.

Do not omit the operations enclosed with a solid line. Perform the operations enclosed with a dashed line as necessary.

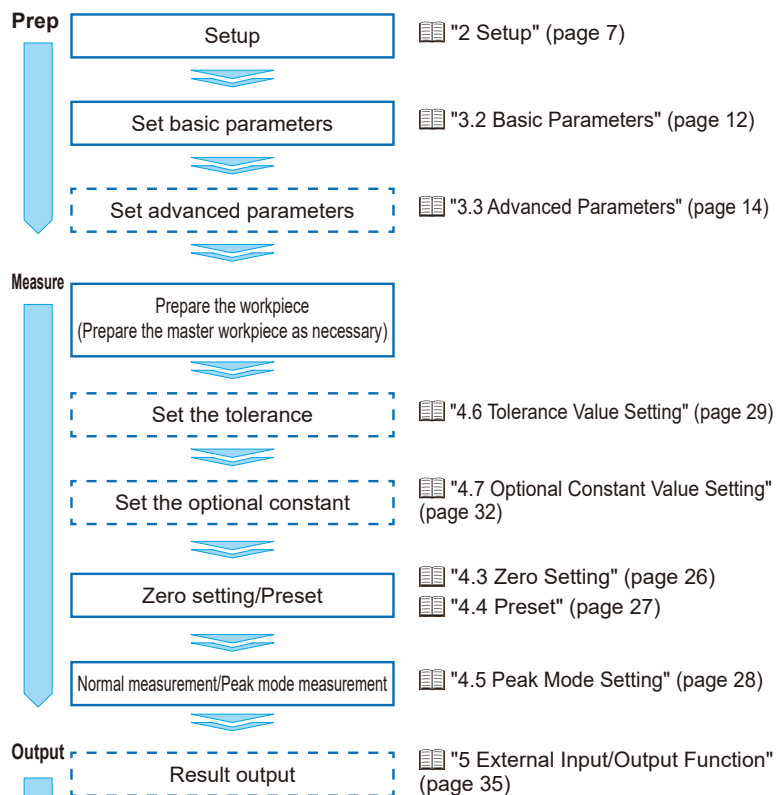

MEMO

## 2 Setup

### 2.1 Unpacking

When unpacking for the first time, check that the following components are contained in the box.

Name	Q'ty	Name	Q'ty
Linear Gage Counter (this product)	1	Stand	1
Washer (plain washer round, nominal diameter: 4)	6	Rubber foot	4
User's Manual (this document)	1	DC plug (MP-121M)	1
AC adapter	1	Warranty	1
AC cable	1		

#### Tips

An AC adapter and AC cable are not supplied with code No. 542-07x-1.

### 2.2 Mounting

#### 2.2.1 Mounting on a Panel

##### ■ Dimensions for the mounting holes in the panel

Width (mm)	Height (mm)	Panel thickness (mm)
138.5 to 139	68.3 to 68.7	1.0 to 3.2

##### ■ Panel mounting procedure

- Loosen the fixing bracket mounting screws (see the following figure), and then remove the fixing brackets.
- Insert the Counter main body from the front side of the panel.
- From the back of the panel, reattach the fixing brackets that you removed in step 1 to the Counter and secure them.

#### Tips

Refer to the table below and select the number of washers to use according to the thickness of the panel.

Panel thickness (mm)	Number of washers
1.0 to 1.3	0
1.4 to 1.7	1
1.8 to 2.5	2
2.5 to 3.2	3

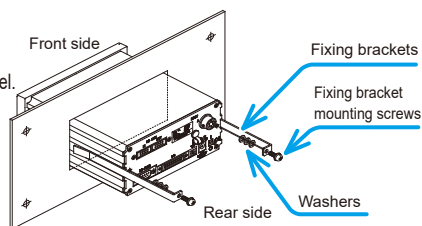

### 2.2.2 Placing on a Desk

#### ■ Placing the Counter flat on a desk

Attach the supplied rubber feet (4 pieces) to the points marked by circles in the figure below to prevent slipping and to minimize vibration.

#### Tips

This product cannot be mounted in a panel with the rubber feet attached.

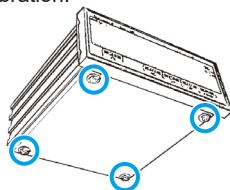

#### ■ Placing the Counter at an incline

Using the fixing brackets, attach the supplied stand to the Counter. The procedure for attaching the supplied fixing brackets is the same as for mounting on a panel. Use 6 washers.  "2.2.1 Mounting on a Panel" (page 7)

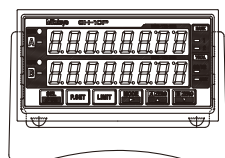

Stand (standard accessory)

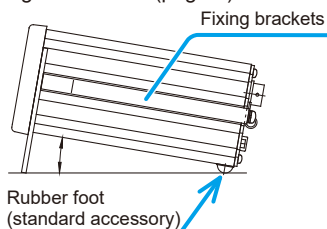

Fixing brackets

Rubber foot (standard accessory)

## 2.3 Connections

### 2.3.1 Power Source

Use the supplied AC adapter and the supplied AC cable. If you will not use the supplied AC adapter, prepare a DC power source (voltage: 12 V to 24 V, output current: 1 A or more) for each Counter. Solder the power cable to the terminals of the supplied DC plug as shown in the figure below.

#### Tips

If you use a commercial power source, use a power cable with a length of 30 m or shorter. Avoid outdoor wiring.

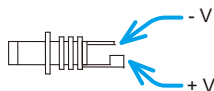

#### NOTICE





Never use this power source with other electric equipment that runs at a high voltage and/or large current.

### 2.3.2 Connecting Cables for External Equipment

You must supply USB, RS-232C, and I/O connector connecting cables for connecting external equipment.

Use a Mitutoyo-approved connecting cable for RS LINK connections.

#### Tips

- For details about USB connecting cables, see  "5.2 USB Communication Function" (page 35).
- For details about RS-232C connecting cables, see  "5.3 RS-232C Communication Function" (page 36).
- For details about I/O connecting cables, see  "5.5 I/O Connector Terminal Function" (page 42).
- For details about RS LINK, see  "5.4 RS LINK Function" (page 40).

### 2.3.3 Connection Procedure

#### NOTICE

- Always turn off the power switch of this product while making connections.
- Do not run the power cable and Linear Gage connecting cable through a cable duct together with other power lines.
- Secure the power cable and connecting cables for external equipment to your equipment with a cable tie, cable holder, etc.



Be sure to connect this product to ground. If this product is not grounded, it will be more susceptible to electrical noise.

Make connections as shown in the figure below.

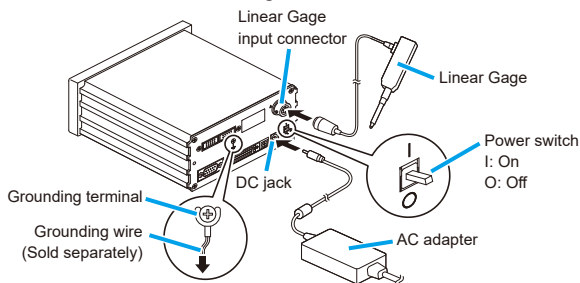

### 2.4 Operation Check

Check the cable connections with the following procedure to confirm that the connections are correct.

- 1 Turn on the power switch.
  - » The Counter enters the stand-by state.



- 2 Press [SEL]/[CE].
  - » The Counter changes to the Counter display.



#### Tips

EH-10ZZ will enter the origin-detection waiting state. To change to the Counter display, push in the contact point of the Linear Gage to make it pass over the origin.

- 3 Check that the counter value is shown on the Display.
- 4 Check that the counter value on the Counter changes by moving the contact point of the Linear Gage up and down.



## 3 Setting Parameters

The settings of the Linear Gage that you will use, the display of the Counter, and external output are specified by setting parameters. Set parameters before you begin measuring.

2-axis models have 4 internal counters that are referred to as "CEL", and depending on the Display mode setting, 6 types of counter values can be specified for each CEL separately. For details, see  "3.4 Details of Display Mode (2-axis Models Only)" (page 17).

### 3.1 Procedure for Setting Parameters

Parameters are set in Parameter mode. As an example, the procedure for using the Linear Gage with a resolution of 5  $\mu\text{m}$  for EH-102P is explained.

#### 1 Turn on the power switch.

- » The Counter enters the stand-by state.



#### 2 Press and hold [P.SET], and then press [A\_ZERO]/[ZERO].

- » The Counter enters Parameter mode.



#### 3 Press [P.SET] repeatedly to advance the parameter number to 12.

- » The current value of parameter number 12 of INPUT A will be displayed.  
(Parameter number 12 sets the resolution.)

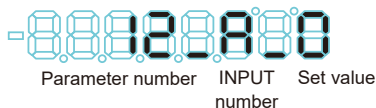

#### 4 Repeatedly press [A\_ZERO]/[ZERO] to set the set value to 1 (resolution: 5 $\mu\text{m}$ ).

- » The value of INPUT A will be set to 1 (the Linear Gage resolution of INPUT A will be set to 5  $\mu\text{m}$ ).

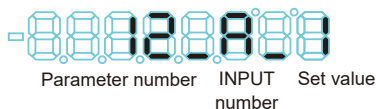

### 3 Setting Parameters

#### 5 Press [P.SET].

- » The current value of parameter number 12 of INPUT B will be displayed.

#### Tips

For 1-axis models, the parameter number will advance. Proceed to step **8**.

#### 6 Repeatedly press [A\_ZERO]/[ZERO] to set the set value to 1 (resolution: 5 $\mu\text{m}$ ).

- » The value of INPUT B will be set to 1 (the Linear Gage resolution of INPUT B will be set to 5  $\mu\text{m}$ ).

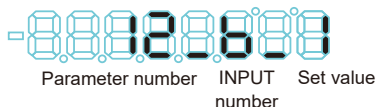

#### 7 Press [P.SET].

- » The set value will be applied.

#### 8 Press and hold [P.SET], and then press [A\_ZERO]/[ZERO].

- » The Counter will return to the stand-by state.



## 3.2 Basic Parameters

This section explains the basic parameters related to measuring. Be sure to set these settings before measuring.

#### Tips

- Correct measurement results may not be obtained if the settings are incorrect.
- The circles in the Counter model columns in the following table indicate whether a parameter number that is displayed on the Counter is valid or invalid (●: valid, ○: invalid).

No.	Setting item	Description/Allowable values (the values in bold indicate the default value)	Counter model			
			P	Z	S	D
00	Parameter mode	Used for setting/saving/loading parameters or setting the optional constant value. <b>0: Parameter setting</b> 1: CEL-specific parameter setting 2: Constant value setting 3: Save parameters 4: Load parameters				

### 3 Setting Parameters

No.	Setting item	Description/Allowable values (the values in bold indicate the default value)	Counter model			
			P	Z	S	D
05	Origin detection function	Selects whether the origin is restored when a Linear Gage with an origin point mark is connected. <b>0: Disabled</b> 1: Enabled	○	●	○	
09	Unit system selection	The unit for displayed values can be set to "mm" or "E units". E=1/25,4 mm. After the unit is set, the default value will not be restored even if the parameters are re-initialized. <b>0: mm</b> 1: E 5/100,000 reading 2: E 1/10,000 reading 3: mm (E 1/10,000 reading when connecting. EH-D only)	●	●	●	●
10	Linear Gage output signal pitch*1	Sets the signal pitch when connected to Linear Gages that output sine-waves. It can be set per axis. 0: 20 μm 1: 4 μm <b>2: 0.25 μm</b>			●	
11	Counter direction	Sets whether the numeral will increase or decrease when the spindle of the Linear Gage is pushed in. It can be set per axis. <b>0: + direction</b> 1: - direction	●	●	●	●
12	Linear Gage resolution*1	Sets the resolution of the Linear Gage that is to be connected to. It can be set per axis. EH-P/Z EH-S*2 EH-D*3 0: 10 μm 0: 10 μm 0: INC 1: 5 μm 1: 5 μm <b>1: ABS</b> <b>2: 1 μm</b> 2: 1 μm 3: 0.5 μm 3: 0.5 μm 4: 0.1 μm 4: 0.1 μm 5: 0.1 μm 5: 0.05 μm (exclusive for <b>6: 0.01 μm</b> 542-711-1 and 7: 0.005 μm 542-712-1) 8: 0.001 μm	●	●	●	●

\*1 The Preset value and tolerance value that had been set will be cleared if the setting is changed.

\*2 The setting range depends on the value set for parameter number 10.

Parameter number 10 = 0: setting range 0 to 4

Parameter number 10 = 1: setting range 2 to 6

Parameter number 10 = 2: setting range 4 to 8

\*3 Select "0: INC" when the Linear Gage that is to be connected to is an INC model. "0: INC" or "1: ABS" can be selected when the Linear Gage is an ABS model.

When "0: INC" is selected:

Match the counter value of both the Linear Gage and the Counter when starting up the Counter. Perform Zero setting, etc., on the Linear Gage side when performing measurement with the values matched.

When "1: ABS" is selected:

The Counter memorizes the origin (0 point) that was set at Counter startup. The origin that was memorized will be valid even if the Counter is re-started.

## 3.3 Advanced Parameters

This section explains the parameters related to the display, functions, and external output of the Counter. Configure the settings appropriate to your application.

### Tips

The circles in the Counter model columns in the following table indicate whether a parameter number that is displayed on the Counter is valid or invalid (●: valid, ○: invalid).

No.	Setting item	Description/Allowable values (the values in bold indicate the default value)	Counter model			
			P	Z	S	D
01	Parameter initialization	If you set the value of this parameter to 1, the set values for all parameters, except for the unit setting, can be reset to their default values (initialized). Once this setting has been enabled, this parameter is reset so its set value is 0 (do not initialize). <b>0: Do not initialize</b> 1: Initialize	●	●	●	●
02	Key protect	Key operations can be disabled to prevent operation errors. <b>0: Key operation enabled</b> 1: Key operation disabled	●	●	●	●
06	Display mode selection*1 (2-axis models only)	Selects the UNIT (counting method) that is assigned to each CEL. The UNIT to be set can be selected as desired. For details, see  "3.4.2 Details of Display Mode Selection (Parameter Number 06)" (page 18).	●	●	●	●
07	Display at startup	Selects stand-by state or Counter display (origin detection wait state for EH-102Z) to display at startup. EH-P/S/D      EH-Z <b>0: [-----] display</b> <b>0: [-----] display</b> 1: 0.000      1: Origin detection wait state	●	●	●	●
13	μ decimal point display (2-axis models only)	If enabled, the decimal point will be displayed at the μm position. This is available if the Linear Gage resolution is 0.05 μm or less. Example: 0.001.00 (1 μm) <b>0: Not displayed</b> 1: Displayed	●	●	●	●
14	Sum/Difference calculation	Specifies the calculation method when Sum/Difference calculation measurement (UNIT C) is selected in parameter number 06. For 1-axis models, this is not available. <b>0: A + B</b> 1: A - B	●	●	●	●

### 3 Setting Parameters

No.	Setting item	Description/Allowable values (the values in bold indicate the default value)	Counter model			
			P	Z	S	D
15	Smoothing	Averages the counter value and then displays it. (This reduces fluctuation of the lowest-order digit.) You can specify the number of measurements to average.  <b>0: None</b> 1: Display the average of 16 measurements 2: Display the average of 32 measurements	•	•	•	○
16	Peak value Preset	Sets whether to perform presetting based on the peak value during Peak mode.  <b>0: Disabled</b> 1: Enabled	•	•	•	•
18	Speed sampling cycle (EH-102P/Z/S only)	In Display mode selection, selects the sampling cycle when Speed display is selected.  <b>0: 0 ms</b> 1: 50 ms 2: 100 ms	•	•	•	
19	Digimatic input WAIT	Sets the wait time for the Digimatic input signal. Change this when the Counter cannot read the input signals from a Digimatic device.  <b>0: No WAIT</b> 1: 100 ms WAIT 2: 200 ms WAIT				•
20	Tolerance output/ BCD output swi- tchover*1	Switches between tolerance judgment result output and BCD output.  <b>0: 3-step tolerance</b> 1: 5-step tolerance 2: BCD output	•	•	•	•
21	BCD output logic*1	Selects whether to use positive logic (0) or negative logic (1) for BCD output.  <b>0: DATA [L] (sign H)</b> 1: DATA [H] (sign L)	•	•	•	•
24	RS-232C/USB/ Digimatic output switchover*2	Selects which output terminal to use.  <b>0: RS-232C</b> 1: USB 2: Digimatic	•	•	•	•
25	Data transfer speed*2	Selects the data transfer speed for RS-232C.  0: 4800 bps <b>1: 9600 bps</b> 2: 19200 bps	•	•	•	•
26	Parity check*2	Selects the parity check method for RS-232C.  0: None                                      1: Odd numbered <b>2: Even numbered</b>	•	•	•	•
27	Data bit*2	Selects the length of the data bit for RS-232C.  <b>0: 7 bit</b> 1: 8 bit	•	•	•	•
28	Output trigger*2	Selects the output trigger method for RS-232C.  <b>0: RS-232C command (normal state)</b> 1: RS-232C command (with channel synchronization function) 2: HOLD trigger	•	•	•	•

### 3 Setting Parameters

No.	Setting item	Description/Allowable values (the values in bold indicate the default value)	Counter model			
			P	Z	S	D
30	Analog output range	Selects the range (resolution range) of the measurement of the analog output.  <b>0: 1999 to -1999</b> 1: 19990 to -19990 2: 199900 to -199900	•	•	•	•
31	Origin detection direction	When a Linear Gage with an origin mark is connected, selects the direction of the spindle of the Linear Gage for origin detection. It can be set per axis.  <b>0: + direction</b> 1: - direction	○	•		
32	Origin re-detection <sup>*3</sup>	When a Linear Gage with an origin mark is connected, sets whether to wait for the origin to be detected without turning off the power in the case of an abnormal stop.  <b>0: Disabled</b> 1: Enabled	○	•		
33	Origin initialization (when the power switch is on)	When a Linear Gage with an origin mark is connected, initializes the origin when the power is on. After the initialization, the set value will be returned to 0 (do not initialize).  <b>0: Do not initialize</b> 1: Initialize	○	•		

\*1 The Preset value and tolerance value that had been set will be cleared if the setting is changed.

\*2 Turn off the power switch after changing the setting. The setting will be applied when you turn on the power switch again.

\*3 When the setting is enabled, the Counter will wait for the origin re-detection when the HOLD signal is raised. If the HOLD signal is input again during origin re-detection, the origin re-detection function will be canceled (except during error detection).

## 3.4 Details of Display Mode (2-axis Models Only)

### 3.4.1 Internal Structure of the Counter

2-axis models have 4 internal counters referred to as CEL (CEL1 to 4). The counter values of CEL1 and CEL2 will be displayed as BANK1, and the counter values of CEL3 and CEL4 will be displayed as BANK2. There are 6 types of counting methods (UNIT A to F). You can select which UNIT will be displayed in each CEL according to the Display mode setting.

#### Tips

- For details about BANK, see [4.2 Switching the Displayed BANK \(2-Axis Models Only\)](#) (page 25).
- For details about Display mode selection, see [3.4.2 Details of Display Mode Selection \(Parameter Number 06\)](#) (page 18).

The relationships between BANK, CEL, and UNIT in the Counter are shown in the following figure.

The following figure shows an example of the Display mode set to Sum/Difference calculation measurement (A - B).

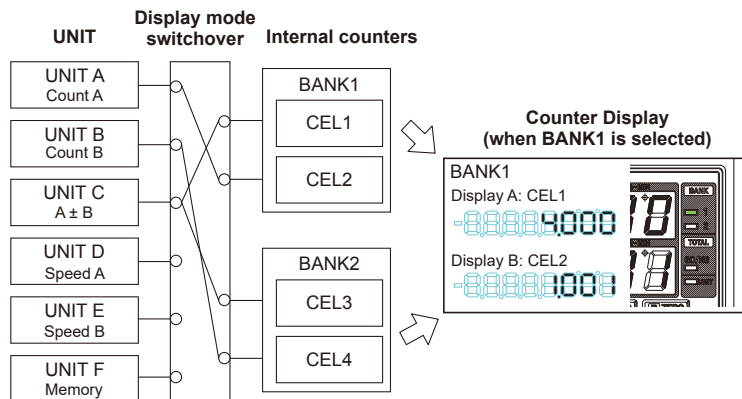

### 3 Setting Parameters

#### 3.4.2 Details of Display Mode Selection (Parameter Number 06)

On 2-axis models, Display mode can be selected by setting parameter number 06 as follows:

Set value	Display mode	BANK1		BANK2	
		CEL1	CEL2	CEL3	CEL4
0 (Default value)	Coordinate display	UNIT A (Count A)	UNIT B (Count B)	UNIT A (Count A)	UNIT B (Count B)
1	Sum/Difference calculation display	UNIT C (A ± B)	UNIT A (Count A)	UNIT C (A ± B)	UNIT B (Count B)
2	Dual display	UNIT A (Count A)	UNIT A (Count A)	UNIT B (Count B)	UNIT B (Count B)
3	Memory display	UNIT A (Count A)	UNIT F (Memory)	UNIT B (Count B)	UNIT F (Memory)
4	Speed display	UNIT A (Count A)	UNIT D (Speed A)	UNIT B (Count B)	UNIT E (Speed B)
5	Optional display (1 CEL)	UNIT A to F	-	-	-
6	Optional display (2 CELs)	UNIT A to F	UNIT A to F	-	-
7	Optional display (4 CELs)	UNIT A to F	UNIT A to F	UNIT A to F	UNIT A to F

#### Tips

The Display mode also controls the number of output data for the external output function (Digimatic output and RS-232C output).

When setting up the system using the external output function, pay attention to the number of output data.

e.g. Selecting the setup value 1: Two selected BANK data are output with the Digimatic output; four data items are output by the displayed data output (GA00CRLF) with the RS-232C output.

Selecting the setup value 5: One selected BANK data is output with the Digimatic output; one data item is output by the displayed data output (GA00CRLF) with the RS-232C output.

#### ■ Display mode types

##### ● Coordinate display (set value: 0)

Displays 2 sets of coordinates using the BANK function.

#### Tips

- The origin and tolerance can be set separately for INPUT A and INPUT B.
- For details about BANK switchover, see  "4.2 Switching the Displayed BANK (2-Axis Models Only)" (page 25).



### 3 Setting Parameters

---

#### ● Sum/Difference calculation display (set value: 1)

Displays the Sum/Difference calculation for thickness or step measurement.

##### Tips



- Set sum (A + B) or difference (A - B) by parameter number 14.
- Connect Linear Gages that have the same resolution to INPUT A and INPUT B.

#### ● Dual display (set value: 2)

In Peak mode measurement, the peak value and the counter value of one Linear Gage are displayed simultaneously. The peak value is displayed on Display A, and the counter value is displayed on Display B.

You can switch between INPUT A and INPUT B using the BANK function.

##### Tips

- For details about peak value switchover, see  "4.5.1 Procedure for Switching Peak Mode" (page 28).
- For details about BANK switchover, see  "4.2 Switching the Displayed BANK (2-Axis Models Only)" (page 25).

#### ● Memory display (set value: 3)

Saves the current value on Display A in Display B. In addition to the most recently saved data, the maximum value and the minimum value from past data can also be read out. The saved data will not be cleared even if the power switch is turned off.

##### Tips

- For details about the procedures for saving, reading out, and clearing memory, see  "4.8 Registering, Reading Out, and Clearing the Memory" (page 34).
- The memory unit is shared between BANK1 and BANK2. Connect Linear Gages that have the same resolution.
- The B\_HOLD signal can be used to write to or clear the memory externally.

#### ● Speed display (set value: 4) (EH-102P/EH-102Z/EH-102S only)

Displays the moving speed of the Linear Gage's spindle simply.

In addition to the current speed, it displays the maximum speed when the maximum value (MAX) is selected in Peak mode.

##### Tips

- Specify the speed sampling cycle by parameter number 18.
- The value is displayed in mm/sec. The display of the last 1 to 3 digits may be fixed depending on the speed sampling cycle.
- The maximum speed in the reverse direction is displayed when the minimum value (MIN) is selected in Peak mode.
- This type is not applicable to feedback control.

### 3 Setting Parameters

---

#### ■ UNIT types (counting methods)

UNIT	Description
UNIT A/B (Count A/Count B)	The current value of INPUT A or INPUT B
UNIT C (A $\pm$ B)	Sum or difference of the current values of INPUT A and INPUT B
UNIT D/E (Speed A/Speed B)	The moving speed of the spindle of the Linear Gage for INPUT A or INPUT B
UNIT F (Memory)	Memory storage of the current value of INPUT A or INPUT B

## 3.5 CEL-Specific Parameters

Each parameter shown below is set separately for each CEL.

For examples of setting CEL-specific parameters, see  "4.7 Optional Constant Value Setting" (page 32).

### Tips

- To set CEL-specific parameters, set 1 as the value for parameter 00. The parameter number will switch to parameter number 40 for 2-axis models, and to parameter number 41 for 1-axis models.
- The circles in the Counter model columns in the following table indicate whether a parameter number that is displayed on the Counter is valid or invalid (●: valid, ○: invalid).

No.	Setting item	Description/Allowable values (the values in bold indicate the default value)	Counter model			
			P	Z	S	D
40	Individual CEL display*1 (2-axis models only)	Selects the UNIT (counting method) to be displayed for each CEL when Display mode is set to "Option".  0: UNIT A (Count A) 1: UNIT B (Count B) 2: UNIT C (A ± B) 3: UNIT D (Speed A) (except for EH-D) 4: UNIT E (Speed B) (except for EH-D) 5: UNIT F (memory)	●	●	●	●
41	Calculation with a constant	Sets whether to multiply the internal counter value by a predetermined value, by an arbitrary value, or to not multiply it. The value obtained by multiplying the internal counter value by the set constant value will be displayed as the measurement result.  <b>0: Do not calculate</b> 1: 1/2 times 2: 2 times                        3: 10 times 4: Arbitrary value	●	●	●	●
42	Hide the lowest-order digit	Hides the lowest-order digit. However, the lowest-order digit will be included in RS-232C output and in printouts.  <b>0: Display all digits</b> 1: Hide the lowest-order digit	●	●	●	●

\*1 The Preset value and tolerance value that had been set will be cleared if this setting is changed.

## 3.6 Overview of Setting Parameters

This section gives an overview of setting parameters.

### Tips

- The following figure does not show the steps for setting parameters.
- When setting parameters, each time you press [P.SET], the parameter number will advance from 00. When the number advances to the last number, it then returns to 00.
- When 1 (CEL-specific parameters setting) is selected as the set value for parameter number 00, the parameter number will switch to parameter number 40 for 2-axis models, and to parameter number 41 for 1-axis models. When the parameter number advances to 42, it will return to 40 for 2-axis models, and to 41 for 1-axis models.
- Be sure to set the parameters enclosed within a solid line. Perform the parameter settings enclosed with a dashed line as necessary.

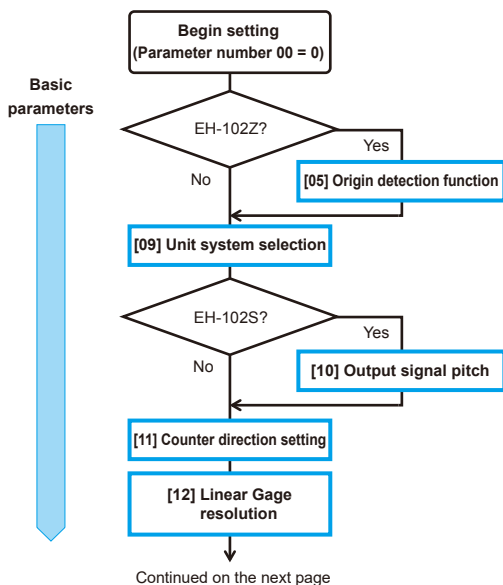

For details about basic parameters, see "3.2 Basic Parameters" (page 12).

### 3 Setting Parameters

Continued from the previous page

Advanced/  
CEL-specific  
parameters

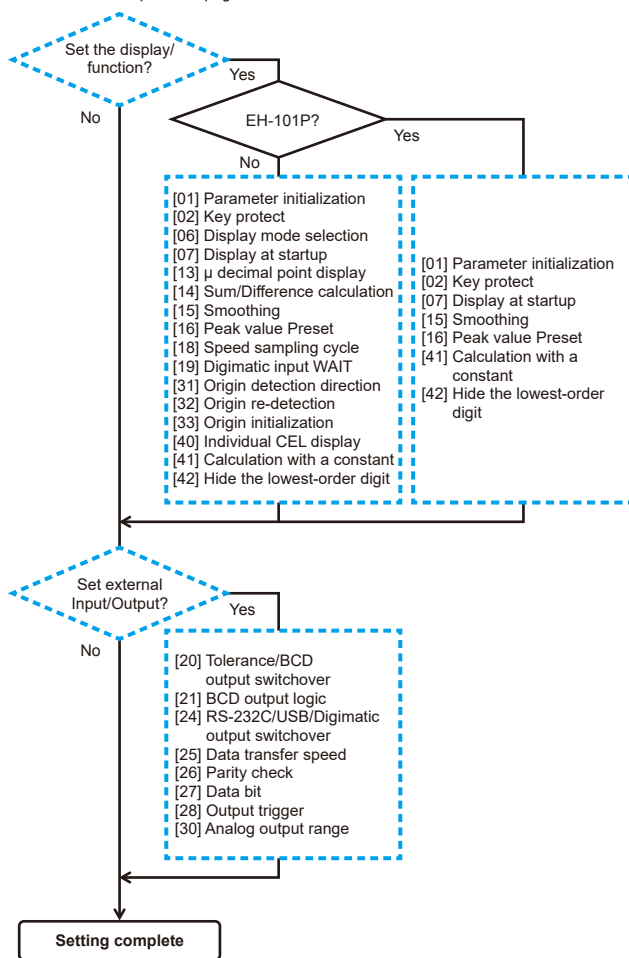

For details about advanced parameters, see "3.3 Advanced Parameters" (page 14).

For details about CEL-specific parameters, see "3.5 CEL-Specific Parameters" (page 21).

### 3 Setting Parameters

---

MEMO

## 4 Basic Operations

### 4.1 Switching Between Display A and B (2-Axis Models Only)

You can select Display A (upper row) or Display B (lower row). For BANK1, Display A is selected to display CEL1 and Display B is selected to display CEL2. For BANK2, Display A is selected to display CEL3 and Display B is selected to display CEL4. For details about CEL, see  "3.4.1 Internal Structure of the Counter" (page 17).

This section explains how to select Display A or B.

#### 1 Press and hold [SEL].

- » The selected Display will blink (the example on the right shows the Display when Display A is assigned to UNIT A (Count A), Display B is assigned to UNIT B (Count B)).

Display A (upper row display): CEL1



Display B (lower row display): CEL2



#### Tips

- When calculation with a constant is set, the LED in the right-most digit will be [=], as shown in Display B.
- For EH-102D, all decimal points blink for about 8 seconds when an error is canceled.

#### 2 Perform step 1 again if the Display is not configured as you want.

### 4.2 Switching the Displayed BANK (2-Axis Models Only)

2-axis models have 4 internal counters that are referred to as "CEL" (CEL1 to 4). CEL1 and CEL2 will be displayed as BANK1, and CEL3 and CEL4 will be displayed as BANK2. The displayed BANK can be switched as necessary. For details about CEL, see  "3.4.1 Internal Structure of the Counter" (page 17).

This section explains how to switch the displayed BANK.

#### 1 Press and hold [P.SET], and then press [MODE].

## 4 Basic Operations

- » The displayed BANK will be switched.

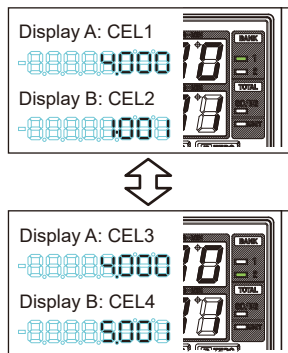

### Tips

The displayed BANK can also be switched by an external signal.

## 4.3 Zero Setting

The current value of the Counter can be set to 0 at any point within the Linear Gage measuring range. Zero setting can be performed separately for each CEL. This section explains how to perform Zero setting.

- 1 If Peak mode measurement has been set, switch to normal measurement.

- » The counter value will be displayed.  
(The figure on the right shows a counter value of 1.000.)



### Tips

For details about switching between Peak mode measurement and normal measurement, see "4.5 Peak Mode Setting" (page 28).

- 2 Select the BANK for which you want to perform Zero setting.

### Tips

For details, see "4.2 Switching the Displayed BANK (2-Axis Models Only)" (page 25).

- 3 Press [A\_ZERO]/[ZERO] or [B\_ZERO].

- » The counter value will change to 0.



- » The maximum and minimum values that were set in Peak mode will be cleared (MAX = MIN = current value, TIR = 0).



### 4.4 Preset

The current value of the Counter can be set to an arbitrary value at any point within the Linear Gage measuring range.

As an example, the procedure for presetting the datum to 10.000 mm is explained.

- 1 Press and hold [SEL]. (For 1-axis models, proceed to step 2.)

» The selected Display will blink.

#### Tips

Each time you press [SEL], the blinking switches between Display A and Display B.

 "4.1 Switching Between Display A and B (2-Axis Models Only)" (page 25)

- 2 Press [P.SET].

» The previous Preset value will be displayed (when the previous value is 10.000).



- 3 Press [MODE].

» The input digit will shift to the right.



- 4 Press [A\_ZERO]/[ZERO] or [B\_ZERO].

» The Preset value will be modified.

- 5 Repeat steps 3 and 4 until you have set the desired Preset value.

- 6 Press [P.SET].

» The Counter will return to the Counter display.

#### Tips

To cancel the input, press [SEL]/[CE]. The Counter will return to the Counter display.

## 4.5 Peak Mode Setting

The maximum value, the minimum value, and TIR value are constantly calculated in the Counter. By switching the mode, you can display the counter value according to the intended application.

Mode	Description
Normal measurement	Counts the movement (displacement) of the contact point of the Linear Gage, and then displays the counter value successively.
Max. hold measurement	Displays the maximum value (MAX) measured during the measurement. The display will not change until a new maximum value is measured.
Min. hold measurement	Displays the minimum value (MIN) measured during the measurement. The display will not change until a new minimum value is measured.
TIR measurement	Displays TIR value during the measurement = TIR (maximum value - minimum value). The display will not change until either a new maximum value or minimum value is measured.

### 4.5.1 Procedure for Switching Peak Mode

This section explains how to switch Peak mode.

- 1 Press and hold [SEL]. (For 1-axis models, proceed to step 2.)

» The selected Display will blink.

#### Tips

Each time you press [SEL], the blinking switches between Display A and Display B.

☰ "4.1 Switching Between Display A and B (2-Axis Models Only)" (page 25)

- 2 Repeatedly press [MODE] until the desired mode is displayed.

» The mode will switch as follows:

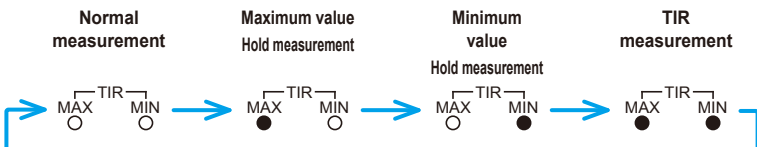

### 4.5.2 Procedure for Clearing the Peak Value

This section explains how to clear the peak value in Peak mode.

- 1 Press and hold [SEL]. (For 1-axis models, proceed to step 2.)

» The selected Display will blink.

### Tips

Each time you press [SEL], the blinking switches between Display A and Display B.  
☰ "4.1 Switching Between Display A and B (2-Axis Models Only)" (page 25)

### 2 Press [MODE].

» Peak mode will be set.

### 3 Press [A\_ZERO]/[ZERO] or [B\_ZERO].

» The peak value will be cleared (MAX = MIN = current value, TIR = 0).

### Tips

- If the same UNIT (counting method) has been assigned to more than 1 CEL, the peak value of all of the CELs that are assigned the same UNIT (counting method) will be cleared when the peak value of one of the CELs is cleared.
- For details about the relationship between BANK, CEL, and UNIT, see ☰ "3.4.1 Internal Structure of the Counter" (page 17).

## 4.6 Tolerance Value Setting

There are 2 settings for the tolerance value: 3-step and 5-step.

The tolerance values can be set separately for each CEL.

### Tips

- Set the value of parameter number 20 to 0 (3-step tolerance) or 1 (5-step tolerance) in advance.
- For details about I/O output, see ☰ "5.5 I/O Connector Terminal Function" (page 42).

### 4.6.1 3-Step Tolerance Value Setting (3-Step Tolerance Zone Selection)

With S1 and S4 set as the tolerance values, the 3-step tolerance judgment will be performed as follows:

Judgment conditions	Tolerance judgment indicator	I/O output (PIN number)
Measurement result < S1	Amber indicator on	AL1 (3) / BL1 (11)
S1 ≤ measurement result ≤ S4	Green indicator on	AL3 (5) / BL3 (13)
S4 < measurement result	Red indicator on	AL5 (7) / BL5 (15)

This section explains how to set the 3-step tolerance value.

### 1 Press and hold [SEL]. (For 1-axis models, proceed to step 2.)

» The selected Display will blink.

### Tips

Each time you press [SEL], the blinking switches between Display A and Display B.  
☰ "4.1 Switching Between Display A and B (2-Axis Models Only)" (page 25)

## 4 Basic Operations

### 2 Press [LIMIT].

- » The Tolerance judgment indicator will light in amber. (Tolerance value S1 will be selected.)

### 3 Press [MODE].

- » The input digit will shift to the right.



### 4 Press [A\_ZERO]/[ZERO] or [B\_ZERO].

- » The tolerance value will be modified.

### 5 Repeat steps 3 and 4 until you have set the desired tolerance value.

### 6 Press [LIMIT].

- » Tolerance value S1 will be applied.
- » The Tolerance judgment indicator will light in red. (Tolerance value S4 will be selected.)

### 7 Set the tolerance value S4 in the same steps as in 3 to 5.

### 8 Press [LIMIT].

- » The tolerance value S4 will be applied, and the Counter will return to the Counter display.

### Tips

An error will occur unless  $S1 \leq S4$ . Press [SEL]/[CE] to redo the input from S1.

## 4.6.2 5-Step Tolerance Value Setting (5-Step Tolerance Zone Selection)

With S1 to S4 set as the tolerance values, the 5-step tolerance judgment will be performed as follows:

Judgment conditions	Tolerance judgment indicator	I/O output (PIN number)
Measurement result < S1	Amber indicator on	AL1 (3) / BL1 (11)
$S1 \leq$ measurement result < S2	Amber indicator blinks	AL2 (4) / BL2 (12)
$S2 \leq$ measurement result $\leq$ S3	Green indicator on	AL3 (5) / BL3 (13)
$S3 <$ measurement result $\leq$ S4	Red indicator blinks	AL4 (6) / BL4 (14)
$S4 <$ measurement result	Red indicator on	AL5 (7) / BL5 (15)

This section explains how to set the 5-step tolerance value.

### 1 Press and hold [SEL]. (For 1-axis models, proceed to step 2.)

- » The selected Display will blink.

## 4 Basic Operations

### Tips

Each time you press [SEL], the blinking switches between Display A and Display B.

 "4.1 Switching Between Display A and B (2-Axis Models Only)" (page 25)

### 2 Press [LIMIT].

- » The Tolerance judgment indicator will light in amber. (Tolerance value S1 will be selected.)

### Tips

Tolerance values are set in the order S1, S2, S3, S4. The Tolerance judgment indicator displays as follows. (The tolerance value to be set will be selected.)

Tolerance value	Tolerance judgment indicator	Tolerance value	Tolerance judgment indicator
S1	Amber indicator on	S2	Amber indicator blinks
S3	Red indicator blinks	S4	Red indicator on

### 3 Press [MODE].

- » The input digit will shift to the right.



### 4 Press [A\_ZERO]/[ZERO] or [B\_ZERO].

- » The tolerance value will be modified.

### 5 Repeat steps 3 and 4 until you have set the desired tolerance value.

### 6 Press [LIMIT].

- » Tolerance value S1 will be applied.
- » The color of the Tolerance judgment indicator will change to the color of the tolerance value that is to be set next.

### 7 Set the tolerance value in order for S2, S3, and S4 as explained in steps 3 to 6.

- » The tolerance values S2, S3, and S4 will be applied, and the Counter will return to the Counter display.

### Tips

An error will occur unless  $S1 < S2 < S3 < S4$  or  $S1 = S2 = S3 = S4$ .

### 4.7 Optional Constant Value Setting

You can specify an internal counter (CEL1 to CEL4) to which a multiplication factor is applied and set the factor for the internal counter value. If this function is used, the accuracy cannot be guaranteed.

#### Tips

For EH-101P, there is only 1 internal counter (CEL).

#### 4.7.1 Procedure for Specifying an Internal Counter

This procedure explains how to specify the internal counter (CEL1 to CEL4) to which a multiplication factor is applied.

- 1 Press and hold [P.SET], and then press [A\_ZERO]/[ZERO].

» The Counter enters Parameter mode.

- 2 Press [A\_ZERO]/[ZERO] once to set parameter number 00 to 1.

» The display appears as to the right.



- 3 Press [P.SET].

» The parameter number will switch to 40.

#### Tips

For 1-axis models, the parameter number will switch to 41. Proceed to step **5**.

- 4 Repeatedly press [P.SET] to advance the parameter number to 41.

» The set value of parameter number 41 for CEL1 will be displayed.



Parameter number      CEL      Set value  
   number

#### Tips

To specify another CEL, repeatedly press [P.SET]. The CEL number will advance.

- 5 Repeatedly press [A\_ZERO]/[ZERO] to set the set value to 4.

» The value will be set to 4. (The Constant value will be set to "Option".)

- 6 Press and hold [P.SET], and then press [A\_ZERO]/[ZERO].

» The Counter will return to the stand-by state.

## 4 Basic Operations

### 4.7.2 Procedure for Setting the Desired Multiplication Factor

This section explains how to set the desired multiplication factor for the selected internal counter.

- 1** Press and hold [P.SET], and then press [A\_ZERO]/[ZERO].

» The Counter enters Parameter mode.

- 2** Press [A\_ZERO] / [ZERO] 2 times to set the parameter number 00 to 2.

» The display appears as to the right.



- 3** Press [P.SET].

» The previous set value will be displayed in Display A, and the CEL number will be displayed in Display B. (The set value of CEL1 will be displayed as to the right.)

Display A



Display B



- 4** Press [MODE].

» The input digit will shift to the right.

- 5** Press [A\_ZERO]/[ZERO] or [B\_ZERO].

» The multiplication factor will be modified.



- 6** Repeat steps **4** and **5** until you have set the desired multiplication factor.

#### Tips

The setting range is  $\pm 9.99999$ .

- 7** Press [P.SET].

» The multiplication factor for CEL1 is applied.  
» The set value of the next CEL will be displayed.

- 8** Set the desired multiplication factor in order for CEL2, CEL3, and CEL4 in as explained in **4** to **7**.

» The multiplication factors for CEL2, CEL3, CEL4 will be applied, and the Counter will return to the Counter display.

# 4.8 Registering, Reading Out, and Clearing the Memory

The following procedures explain how to register, read out, and clear the memory.

### Tips

- This operation is available when the set value for parameter number 06 is 3 (memory display).
- When BANK1 is selected, the current value of INPUT A will be displayed on Display A. When BANK2 is selected, the current value of INPUT B will be displayed on Display A. For details about BANK switchover, see  "4.2 Switching the Displayed BANK (2-Axis Models Only)" (page 25).

### ● Procedure to register the memory

**1** Press [B\_ZERO].

- » The current value in Display A is stored in Display B.

### ● Procedure to read out the stored data

**1** Press and hold [SEL] to select Display B.

### Tips

For details, see  "4.1 Switching Between Display A and B (2-Axis Models Only)" (page 25).

**2** Press [MODE] (switch to Peak mode).

- » Each time you press [MODE], the displayed memory value will cycle through maximum value → minimum value → TIR value.

### ● Procedure to clear the memory

**1** Press and hold [SEL] to select Display B.

### Tips

For details, see  "4.1 Switching Between Display A and B (2-Axis Models Only)" (page 25).

**2** Press [P.SET].

- » The value in memory (maximum value/minimum value/TIR value) will be cleared, and then the current value in Display A will be displayed.



## 5 External Input/Output Function

This product is equipped with the following interfaces that enable the connection of external equipment.

Interface	Parameter setting (No. 24)	Connectable equipment	Functions
Digimatic output	2	Digimatic Mini-Processor (DP-1VR)	<ul style="list-style-type: none"> <li>Printing the measurement data, statistical calculation results, etc.</li> </ul>
USB	1	PC (for SENSORPAK)	<ul style="list-style-type: none"> <li>Data output to a PC</li> </ul>
RS-232C	0	PC, PLC	<ul style="list-style-type: none"> <li>Data output to a PC, PLC</li> <li>Control from external system</li> </ul>
I/O connector	-	Equipment such as a switch or control unit	<ul style="list-style-type: none"> <li>Data output to PLC</li> <li>External control of Counter</li> </ul>

### Tips

PLC: programmable logic controller

### 5.1 Digimatic Output Function

You can print the measurement data by connecting to a Digimatic Mini-Processor (DP-1VR), which is sold separately. When connecting, connect the Digimatic cable to the RS\_LINK connector (OUT) of the Counter.

#### Tips

- A maximum of 6 digits can be printed. When Counter displays the value in 7 or 8 digits, the last 6 digits will be printed. For example, when "12.34567 mm", which has 7 digits, is output, it will be printed as "2.34567 mm".
- Set the DP-1VR to compatible mode. For details about the setting method and operations, see the User's Manual for DP-1VR.

### 5.2 USB Communication Function

By installing SENSORPAK (Mitutoyo product) on a PC, you can load measurement data from a Counter to the PC by connecting the Counter to the PC with a USB connecting cable (A-B type). A USB connecting cable is not supplied. You must provide one.

#### Tips

- The USB port for communication with SENSORPAK.
- For details about SENSORPAK, see the SENSORPAK User's Manual.

## 5.3 RS-232C Communication Function

By connecting to a PC or PLC via RS-232C, you can load measurement data and manipulate various settings of the Counter through remote operation.

You can also save and load parameters.

### 5.3.1 Connections

#### Compatible plug and pin assignment

Compatible plug: D-sub 9-pin (female), inch screw type

Cable: A commercial RS-232C cross-type cable

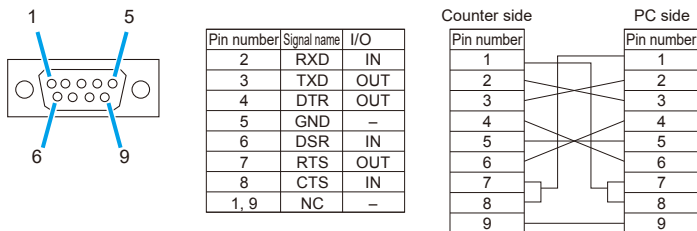

#### Communication specification (conforming to EIA RS-232C)

Item	Description
Home position	DTE (Data Terminal Equipment), use a cross-type cable.
Communication method	Half-duplex, non-procedural mode
Data transfer speed	4800 bps/9600 bps/19200 bps
Bit configuration	Start bit: 1 Data bits: 7 bits/8 bits (ASCII code, upper-case characters) Parity: None/Even parity/Odd parity Stop bit: 2

#### Tips

- Set communication conditions using parameters.  
For details, see "3.3 Advanced Parameters" (page 14).
- Use commercial terminal software for communication with a PC.

### 5.3.2 Communication Commands

This section explains the command format from a PC or PLC, output from the Counter, and operation details.

Command format	Corresponding output	Operation details	Notes
GA**CRLF	G#**, +01234.567CRLF	Outputs "Display value"	See *1
CN**CRLF	CH**CRLF	Switches the display to "Current value"	See *2
CX**CRLF	CH**CRLF	Switches the display to "Maximum value"	See *2
CM**CRLF	CH**CRLF	Switches the display to "Minimum value"	See *2
CW**CRLF	CH**CRLF	Switches the display to "TIR"	See *2
CR**CRLF	CH**CRLF	Zero setting	
CL**CRLF	CH**CRLF	Clears the peak value	
CP**,+01234567CRLF	CH**CRLF	Inputs the Preset value	See *3
CD**,+01234567CRLF	CH**CRLF	Inputs tolerance value S1	See *3
CE**,+01234567CRLF	CH**CRLF	Inputs tolerance value S2	See *3
CF**,+01234567CRLF	CH**CRLF	Inputs tolerance value S3	See *3
CG**,+01234567CRLF	CH**CRLF	Inputs tolerance value S4	See *3
CS**CRLF	CH**CRLF	Clear error	
CK**CRLF	CH**,%CRLF	Checks the HOLD status	See *4, *5

\*1 \*\*\*\* denotes an RS-232C Linear Gage channel number (01 to 99) ("00" means all channels). Channels 01 to 04 correspond to CEL1 to CEL4, respectively.

A "#" after "G" in the output data denotes the type of data (N: Current value, X: Maximum value, M: Minimum value, W: TIR).

\*2 If Peak mode is switched using an RS command, data will not be backed up in internal memory.

\*3 For the Preset value and tolerance value, enter a value consisting of a +/- sign and an 8-digit of numeric value without a decimal point.

Perform the tolerance setting in the order CD command → CG command for 3-step tolerance, and in the order CD command → CE command → CF command → CG command for 5-step tolerance.

An error will be output in the following cases. In this case, redo the settings from the CD command.

- If the order of the tolerance values is incorrect
- If the step count and sent data are different
- If incorrect data is sent

\*4 The response output from the CK command ("%") shows the HOLD status.

%=0: Normal status/1: HOLD status

\*5 If parameter number 28 is 1 (channel synchronization), all Counters that are connected via RS LINK when the CK command is sent will switch to the HOLD state.

The HOLD state will be canceled by reading out data with the GA command.

The CK command is valid only with channel number 1 (CK01CRLF).

### Tips

- CRLF means CR (carriage return) plus LF (line feed).
- The output when an error occurs is "CH\*\*,Error\$\$CRLF". \$\$ is the error code. For details, see  "6.2.1 List of Error Codes" (page 50).
- After you have received a response output corresponding to the command, send the next command. If there is no response from your command, clear the communication buffer, wait 1 second or more, and then send the command again.
- The RS communication function will be suspended during key operation (e.g., setting parameters, the Preset value, or tolerance values). Command and data output operations will resume when the Counter returns to a state where counting is possible.
- To cancel the stand-by state, use "CS00CRLF" (all channels specified).

### 5.3.3 Saving and Loading Parameters

The set parameter data can be output to a PC and then saved to a text file. The data saved to a PC can also be loaded.

This section explains how to store parameters.

#### Tips

To communicate with a PC, you must have appropriate communication software on the PC. Use commercial terminal software.

#### ■ Saving parameters

**1** Press and hold [P.SET], and then press [A\_ZERO]/[ZERO].

» The Counter enters Parameter mode.

**2** Press [A\_ZERO]/[ZERO] 3 times to set the parameter number 00 to 3.

**3** Press [P.SET].

- » The display to the right appears for 1 second, and then the data is output to the PC.
- » After the data is transmitted, the Counter returns to the stand-by state.



#### Tips

- Transmission conditions (fixed): 9600 bps, 7-bit data, even parity, 2-bit stop bits
- Connect the Counter to the PC one-to-one (LINK connection not permitted).

## 5 External Input/Output Function

### ● Example of external output of parameters

An example of the output of parameters is shown below.

#### Tips

The set values for the parameters in the table below are set by the user.

```
CQ01,**EH-S [200]**:00
CQ01,P02__=[0],0-1:02
CQ01,P05__=[0],0-1:03
...
CQ01,P10_A_[0],0-1:36
CQ01,P10_B_[0],0-1:37
...
CQ01,P40_1_[0],0-4:42
CQ02,P40_2_[0],0-4:43
CQ03,P40_3_[0],0-4:44
CQ04,P40_4_[0],0-4:45
...
CQ01,*parameter END*:FF
```

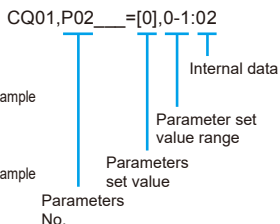

### ■ Loading parameters

This section explains how to read parameters.

#### 1 Press and hold [P.SET], and then press [A\_ZERO]/[ZERO].

» The Counter enters Parameter mode.

#### 2 Press [A\_ZERO]/[ZERO] 4 times to set the parameter number 00 to 4.

#### 3 Press [P.SET].

» The display appears as to the right.



#### 4 Send the parameter file from the PC.

» If it is successfully received, the display to the right will appear.



#### 5 Press [P.SET].

» The Counter will return to the stand-by state.

#### Tips

After loading the parameters, turn off the power switch once, and then turn it on again.

### 5.3.4 Timing Chart

#### RS-232C command input and response output

(Parameter number 28: 0 or 1)

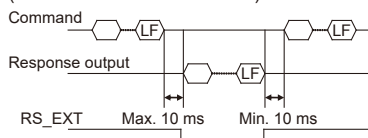

#### HOLD input and response output

(Parameter number 28: 2)

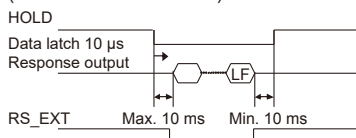

#### Tips

- RS output will be suspended during command operation.
- While the HOLD trigger is selected, the RS-232C commands are disabled.
- When connected via RS LINK, RS\_EXT of the last Counter is active.
- For EH-102D, the time up to the data latch depends on the type of the Linear Gage.

## 5.4 RS LINK Function

With PC (including SENSORPAK) or PLC control, you can control a maximum of 10 Counters using the RS LINK function.

### 5.4.1 Connections

Connect between IN and OUT of the RS\_LINK connectors as shown in the following figure.

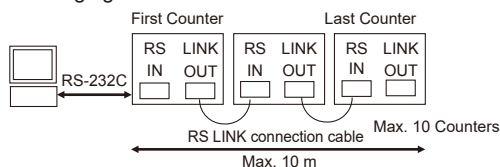

#### Tips

- When using SENSORPAK, you can connect to a PC using USB 2.0.
- Do not connect anything to the RS\_LINK connector (IN) of the first Counter or to the RS\_LINK connector (OUT) of the last Counter.
- When the power switch is turned on and the settings are initialized, the channel number of the Linear Gages will be automatically assigned 01, 02, and 03 from the first Counter in the order in which they are connected.
- Contact Mitutoyo if you wish you connect 10 or more Counters or use a total cable length of 10 m or more.
- For about the RS LINK connection cable, see "7.3 Option" (page 54).

### ■ Precautions for startup

- Either turn on the power switch of all Counters simultaneously or turn on the power switch of each Counter sequentially, beginning with the first Counter.
- After startup, [- - - -] will blink, and then, after the initial settings have completed, the Counter enters the stand-by state, where [- - - -] is displayed. This state can be canceled using [SEL]/[CE], an external HOLD signal, or an RS command.

#### **Tips**

For details, see  "6.2.1 List of Error Codes" (page 50).

- Parameters relating to RS-232C (No. 25 to 28) can be modified only on the first Counter. If you modify a parameter, reset the power switch of all connected Counters.

### 5.4.2 RS-232C Data Output Duration

The maximum output duration of the command to output all data (GA00CRLF) can be calculated with the following formula:

Maximum output duration [ms] = Number of connected Counters × 5 + Number of connection channels × 17 (8.5) + 6 (3)

#### **Tips**

Transmission rate is 9600bps. The values enclosed in ( ) show the case of 19200 bps.

Calculation example:

1 EH-102 + 1 Linear Gage channel = Max. 28 (16.5) ms

10 EH-102 + 20 Linear Gage channels = Max. 396 (223) ms

#### **Tips**

Processing time of the PC is not included.

## 5.5 I/O Connector Terminal Function

Through the I/O connector, the signal of tolerance judgment results, measurement data, etc can be output to an external device. You can also switch the displayed BANK, switch Peak mode, activate the Preset function, clear the peak value, etc., by an external signal input.

### 5.5.1 Connections

#### Compatible plug and pin assignment

Compatible plug:

- Option No. 02ADB440 (plug and cover set)
- Commercial plug 10136-3000PE (3M), cover 10336-52A0-008 (3M)
- Commercial plug DX40M-36P (HIROSE), cover DX30M-36-CV (HIROSE)

Cable: Use shielded wires and limit the connecting cable length to 3 m or less.

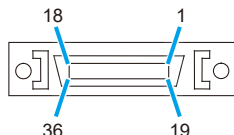

Pin number	I/O	Tolerance judgment output mode		BCD output mode	
		Name	Functions	Name	Functions
1, 2	-	COM	Internally connected to GND	COM	Internally connected to GND
3	O	AL1	INPUT A: Tolerance judgment result output for Display A <ul style="list-style-type: none"> <li>• Relevant terminal output: "L"</li> <li>• Output on error: AL1, AL5: "L" AL2, AL3, AL4: "H"</li> </ul>	A_bit0	INPUT A: Data for Display A
4	O	AL2		A_bit1	
5	O	AL3		A_bit2	
6	O	AL4		A_bit3	
7	O	AL5		A_SIGN	
8	I/O	ALLGO	Total tolerance judgment result output GO (OK): "H" NG: "L"	READY	Data valid: "L"
9	O	RS_EXT	RS output in process: "L"		
10	O	NOMAL	Output when counting is possible: "L", Output on error: "H"		
11	O	BL1	INPUT B: Tolerance judgment result output for Display B <ul style="list-style-type: none"> <li>• Relevant terminal output: "L"</li> <li>• Output on error: BL1, BL5: "L" BL2, BL3, BL4: "H"</li> </ul>	B_bit0	INPUT B: Data for Display B
12	O	BL2		B_bit1	
13	O	BL3		B_bit2	
14	O	BL4		B_bit3	
15	O	BL5		B_SIGN	
16 to 21	-	-	Not connected		
22	O	A_ANG	INPUT A analog output		



## 5 External Input/Output Function

Pin number	I/O	Tolerance judgment output mode		BCD output mode	
		Name	Functions	Name	Functions
23	O	B_ANG	INPUT B analog output		
24	-	AGND	GND for analog		
25	I	SET1	Input the set value with SET in advance, then assign with MODE, DISP.		
26	I	SET2			
27	I	SET3			
28	I	DISP		Specify BANK for display: In combination with SET	
29	I	MODE	Peak switchover: In combination with SET		
30	I	BCDCK	Specify BCD output: In combination with SET		
31	I	EXTTRG	USB trigger		
32	I	A_HOLD	INPUT A HOLD (Display A: HOLD) During input, the decimal point will blink.		
33	I	B_HOLD	INPUT B HOLD (Display B: HOLD) During input, the decimal point will blink.		
34	I	HOLD	HOLD/Error cancel input During input, the UNIT Indicator will blink.		
35	I	PA	INPUT A: Display A Preset/Peak clear (in Peak, HOLD mode)		
36	I	PB	INPUT B: Display B Preset/Peak clear (in Peak, HOLD mode)		

### Tips

- The functions with "INPUT B" written in function field are available for 2-axis models only.
- "I/O" refers to the first letters of "Input/Output" respectively. Refer to the input circuit for "I", and the output circuit for "O".

### Input/Output circuit

#### Output circuit

Transistor is on when the output is "L" (open collector).

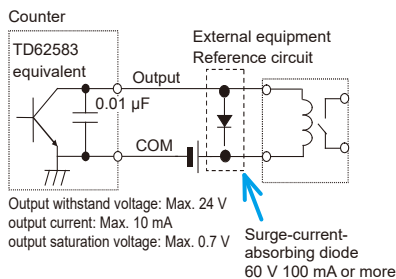

#### Input circuit

Input is valid when the input voltage is "L".

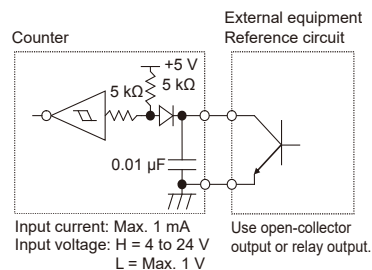

### NOTICE

When using relays, incorporate a surge-current-absorbing diode or a protective circuit. If no protection is incorporated, the IC in the Counter may be damaged.

## 5.5.2 Output Function

### Output of total tolerance judgment result

On 2-axis models, you can output the Total Judgment result of both INPUT A and INPUT B and the Total Judgment result of multiple Counters when multiple Counters are connected.

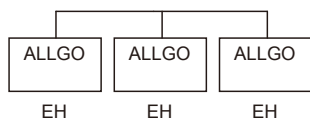

Judgment	Total Judgment indicator	External output ALL_GO
All Counters OK	Green	H
All or some Counters NG	Amber	L
Error	Red	L

### Tips

- To enable this function, select 0 or 1 as the set value of parameter number 20.
- For the Total Judgment across multiple Counters, wire the number 8 pins (ALLGO: total tolerance judgment result output) together.
- For USB output, the Total Judgment indicator lights in amber in normal conditions and in red when an error has occurred. Perform the total tolerance judgment with SENSORPAK (optional software).
- For BCD output, the Total Judgment indicator lights in amber in normal conditions and in red when an error has occurred.
- For details about the timing chart, see "5.5.4 Timing Chart" (page 46).

### BCD output

Outputs measurement data in BCD format. Measurement data from INPUT A and INPUT B is output simultaneously in 4-bit units beginning with the last digit. An overview of the data format is as follows.

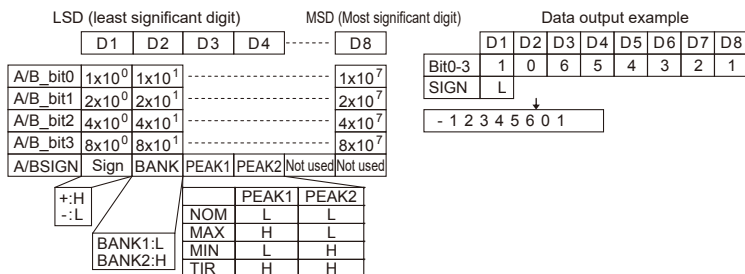

## 5 External Input/Output Function

### Tips

- To enable this function, select the set value 2 (BCD output) of parameter number 20 (tolerance/BCD output mode switching).
- It is possible to invert the SIGN/BANK/PEAK/DATA output logic by setting parameter number 21 (logic selection) to 1 (H).
- For details about the timing chart, see  "5.5.4 Timing Chart" (page 46).

### ■ Analog output

Movement of the spindle of a Linear Gage can be monitored as linear voltage by measuring the voltage between terminals with a pen recorder or oscilloscope.

INPUT A: Pin numbers 22–24

INPUT B: Pin numbers 23–24

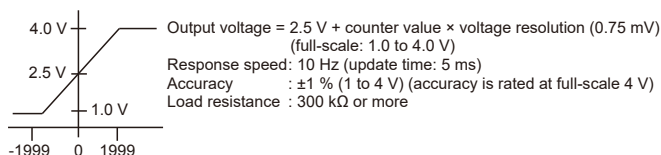

parameters No. 30	Measurement range [mm] (range resolution [mm])		
	10 μm gage	1 μm gage	0.1 μm gage
0	±19.99 (0.01)	±1.999 (0.001)	±0.1999 (0.0001)
1	±199.90 (0.1)	±19.990 (0.01)	±1.9990 (0.001)
2	±1999.00 (1)	±199.900 (0.1)	±19.9900 (0.01)

### 5.5.3 Input Function

With an external signal input, you can switch the BANK, switch Peak mode, activate the Preset function, clear the peak value, set the memory, and clear the memory. You can also activate a HOLD on the counter values of INPUT A and INPUT B either separately or simultaneously.

### Tips

For details about the timing chart, see  "5.5.4 Timing Chart" (page 46).

### 5.5.4 Timing Chart

#### ■ Tolerance judgment result output

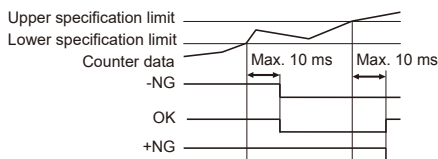

#### Tips

- After acquiring the counter data, there is a maximum 10 ms delay before the tolerance judgment result is output.
- For EH-102D, the length of time until the tolerance judgment result is output after the counter data enters in the Specification range depends on the connected equipment, such as the Linear Gage.

#### ■ BCD output

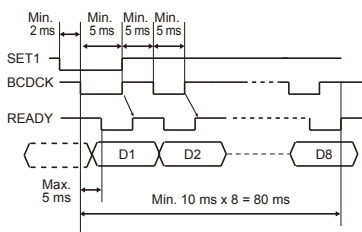

#### Tips

- "SET1" and "BCDCK" (BCD clock) denote input signals, and "READY" denotes the output signal.
- The BCD data (D1, D2 in the figure above) will be modified at the fall of the BCD clock while SET1 is input. When the BCD data is accepted, the READY signal falls. The time to accept the data after the fall of the BCD clock is 5 ms maximum. The READY signal rises together with the BCD clock.

## 5 External Input/Output Function

### External signal input

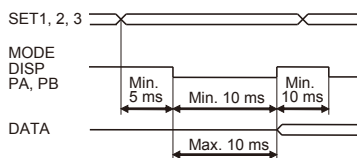

Refer to the following table to set the SET signal.

After setting, leave a gap of 5 ms or more, and then input the input signal of the function to change for at least 10 ms.

The data will be modified within 10 ms after the fall of the input is confirmed.

#### DISP (pin number 28):

##### Switching the displayed BANK

	SET3	SET2	SET1
BANK1	H	H	H
BANK2	H	H	L

#### PA/PB (pin numbers 35, 36):

##### Preset, Peak clear

	SET3	SET2	SET1
Preset	H	H	H
Peak clear	H	H	L

#### MODE (pin number 29):

##### Switching Peak

	SET3	SET2	SET1
NOMAL	H/L	H	H
MAX	H/L	H	L
MIN	H/L	L	H
TIR	H/L	L	L

#### A/B\_HOLD (pin numbers 32, 33):

##### Setting/Clearing memory

	SET3	SET2	SET1
Setting memory	H	H	H
Clearing memory	H	H	L

### Tips

- During Peak mode, the peak value will be cleared when you input the PA/PB signal while HOLD is being input.
- When switching Peak, SET3 is: H for channel 1, L for channel 2.
- A/B\_HOLD signal is available when the relevant channel is UNIT F (memory unit).

## 5 External Input/Output Function

### ■ HOLD/Error reset

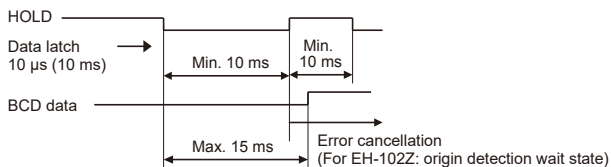





### Tips

- The data latch function and error cancellation function are assigned to the HOLD signal.
- The data latch function will be executed 10 μs (or 10 ms when the HOLD input is active axis by axis) after the fall of the HOLD signal. The error cancellation will be executed with the rising HOLD signal.
- When outputting BCD data, start the data output within 15 ms after the data latch.
- For EH-102D, the length of time until the data latch depends on the connected equipment, such as a Linear Gage.
- During HOLD input, the UNIT indicator will blink.

# 6 Troubleshooting

## 6.1 Troubleshooting

When the Counter does not operate as expected, refer to the cause of the trouble and the solutions shown below:

Problem	Cause	Solution
The counter value is incorrect (not counting).	Parameters are not correctly set for the type of the Linear Gage, etc.	Set correct parameters. For details, see  "3.2 Basic Parameters" (page 12).
	Peak mode (MAX or MIN is lit) is active.	Cancel Peak mode. For details, see  "4.5.1 Procedure for Switching Peak Mode" (page 28).
	The HOLD signal (UNIT is blinking) is being input.	Check the external input.
	Calculation with a constant function is set.	Cancel calculation with a constant function. (Set parameter number 41 to 0.)
Cannot execute Zero setting.	Peak mode is active.	Cancel Peak mode. For details, see  "4.5.1 Procedure for Switching Peak Mode" (page 28).
Cannot establish RS-232C communication.	The RS-232C connecting cable is not properly connected.	Check the cable connection.
	RS-232C mode is not active.	Activate RS-232C mode. (Set parameter number 24 to 0.)
	The command or HOLD trigger setting is not appropriate.	Check the command or HOLD trigger setting (parameter number 28).
	The communication conditions are not set correctly.	Check the settings of the communication conditions. For details, see  "3.3 Advanced Parameters" (page 14).

## 6.2 Error Messages

### 6.2.1 List of Error Codes

Display/ Total tolerance indicator	RS-232C output	NOM signal	Tolerance/ BCD	Cause	Solution/ Error cancellation method
Error 10 Red indicator on	Error_10	H	L1 = L L5 = L FFFF10	Abnormal power voltage	Connect to the specified voltage. Automatic cancellation
[----] blinks —	—	H	L1 = H L5 = H —	RS link is in its initial setting state	Re-check the RS LINK connection cable connection. Automatic cancellation, or turn on the power switch again.
[-----] Red indicator on	Error_15	H	L1 = L L5 = L FFFF15	In stand-by state after power- on or a power interruption	Re-check the power if a power interruption has occurred. • [SEL]/[CE] • CS00CRLF (RS) • HOLD input (I/O)
Error 20 Red indicator on	Error_20	H	L1 = L L5 = L FFFF20	Excess speed	Revise the measurement conditions. • [SEL]/[CE] • CS00CRLF (RS) • HOLD input (I/O)
Error 30 Red indicator on	Error_30	H	L1 = L L5 = L FFFF30	Counter value is 8 digits or more	Modify the Preset value. • [SEL]/[CE] • CS00CRLF (RS) • HOLD input (I/O)
Error 40 Red indicator on	Error_40	H	L1 = L L5 = L FFFF40	Linear Gage malfunction or excess speed	• Check the Linear Gage connection. • Revise the measurement conditions. • [SEL]/[CE] • CS00CRLF (RS) • HOLD input (I/O)
Counter value —	Error_50	L	Counter value status Counter value status	RS communication setting malfunction	Set the RS communication conditions again. Automatic cancellation
Counter value —	Error_52	L	Counter value status Counter value status	RS command malfunction	Revise the RS command. Automatic cancellation



## 6 Troubleshooting

Display/ Total tolerance indicator	RS-232C output	NOM signal	Tolerance/ BCD	Cause	Solution/ Error cancellation method
Error 55 Red indicator on	—	H	L1 = L L5 = L FFFF55	RS LINK malfunction, HOLD trigger malfunction	Check the unit's connection status, I/O connector connection circuit, and power, etc. Turn on the power switch again.
Error 70 Red indicator on	Error_70	H	L1 = L L5 = L FFFF70	Wrong resolution for calculation axis	Revise the measurement conditions. Automatic cancellation
Error 80 Red indicator on	Error_80	H	L1 = L L5 = L FFFF80	Peak detection error (Excess speed)	Revise the measurement conditions. • [SEL]/[CE] • CS00CRLF (RS) • HOLD input (I/O)
Error 90 —	Error_90	L	Counter value status Counter value status	Tolerance value setting error	Input the tolerance value again. [SEL]/[CE]
Error 95 —	Normal output	L	Counter value status Counter value status	Key protect	Cancel the key protection parameters. Automatic cancellation

### Tips

- In the "Solution/Error cancellation method" column, "RS" denotes an RS232C command and "I/O" denotes an external HOLD signal.
- The error output format of RS-232C is "CH\*\*,Error\$\$CRLF".
- "Error 40" (Linear Gage malfunction) is displayed even when no Linear Gage is connected.
- "Error 90" and "Error 95" are displayed when a tolerance value setting error occurs due to a key operation.
- "Error\_90" in the RS-232C output means that a tolerance value setting error has occurred due to an RS command.
- If an error occurs while you are setting parameters, the Preset value, or the tolerance value, the error will be displayed after you return to the counter state. However, the error signal will be output immediately to any external output.

### 6.2.2 Error Cancellation Method

The 3 main error cancellation methods are explained below, but the appropriate method differs depending on the cause.

- Automatic cancellation
- Press [SEL]/[CE].
- Input an external HOLD signal.

#### **Tips**

For details about error messages, see  "6.2.1 List of Error Codes" (page 50).

# 7 Specifications

## 7.1 Basic Specifications

Code No.	542-075	542-071	542-073	542-074	542-072
Model No.	EH-101P	EH-102P	EH-102Z	EH-102S	EH-102D
Number of display axis	1 axis	2 axes			
Display	Minus (-) sign and 8 numeric digits (green LED)				
Minimum reading	0.01/0.005/0.001/0.0005/0.0001 mm (selection by parameter)			0.01/0.001 $\mu$ m	Set automatically according to the gage
Maximum input frequency	2.5 MHz (2-phase square wave)			1 MHz (2-phase sine-wave)	
Power source voltage	Supplied AC adapter or DC +12 V to 24 V				
Power consumption	Max. 8.4 W (Max. 700 mA); Guarantee a minimum power supply of 1 A per unit from the commercial power supply.				
Operating temperature (humidity) range	0°C to 40°C (20% RH to 80% RH, without condensation)				
Storage temperature (humidity) range	-10°C to 50°C (20% RH to 80% RH, without condensation)				
External dimensions	144 (W) × 72 (H) × 156.7 (D) mm				
Mass	Approx. 760 g	Approx. 800 g	Approx. 800 g	Approx. 900 g	Approx. 800 g
CE marking/UKCA marking	EMC Directive/Electromagnetic Compatibility Regulations: EN IEC 61326-1 Immunity test requirement: Clause 6.2 Table 2 Emission limit: Class B RoHS Directive/The Restriction of the Use of Certain Hazardous Substances in Electrical and Electronic Equipment Regulations: EN IEC 63000				
Functions	Zero setting, Preset, Measurement mode switching (maximum value, minimum value, TIR value), Tolerance judgment output (3-step/5-step switchable), Constant factor scaling display				
	Calculation between axes (sum, difference)				
Interface	RS-232C / USB / Digimatic / I/O				



## 7.2 External Dimensions Drawing (For All Models)

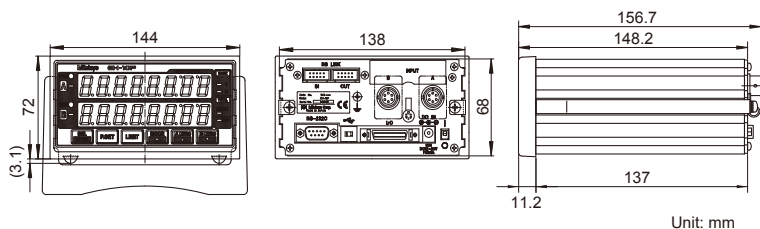

## 7.3 Option

Part No.	Name
02ADB440	I/O output connector (with cover)
02ADD950	RS LINK connection cable (0.5 m)
936937	RS LINK connection cable (1 m)
965014	RS LINK connection cable (2 m)
02NGB072	SENSORPAK/E (software for PC)
02NGB073	SENSORPAK/E (software for PC) with I/O connecting cable

---

# SERVICE NETWORK

\*As of June 2023

## Europe

### Mitutoyo Europe GmbH

Borsigstrasse 8-10, 41469 Neuss, GERMANY  
TEL: 49 (0)2137 102-0 FAX: 49 (0)2137 102-351

### Mitutoyo CTL Germany GmbH

Von-Gunzert-Strasse 17, 78727 Oberndorf,  
GERMANY  
TEL: 49 (0)7423 8776-0 FAX: 49 (0)7423 8776-99

### KOMEG Industrielle Messtechnik GmbH

Zum Wasserwerk 3, 66333 Völklingen, GERMANY  
TEL: 49 (0)6898 91110 FAX: 49 (0)6898 911100

## Germany

### Mitutoyo Deutschland GmbH

Borsigstrasse 8-10, 41469 Neuss, GERMANY  
TEL: 49 (0)2137 102-0 FAX: 49 (0)2137 86 85

### M³ Solution Center Hamburg

Tempowerkring 9-im HIT-Technologiepark 21079  
Hamburg, GERMANY

TEL: 49 (0)40 791894-0 FAX: 49 (0)40 791894-50

### M³ Solution Center Berlin

Ernst-Lau-Straße 6, 12489 Berlin, GERMANY  
TEL: 49(0)30 2611 267 FAX: 49 30 67988729

### M³ Solution Center Eisenach

Neue Wiese 4, 99817 Eisenach, GERMANY  
TEL: 49 (0)3691 88909-0 FAX: 49 (0)3691 88909-9

### M³ Solution Center Ingolstadt

Marie-Curie-Strasse 1A, 85055 Ingolstadt,  
GERMANY  
TEL: 49 (0)841 954920 FAX: 49 (0)841 9549250

### M³ Solution Center Leonberg

Am Längenbühl 3, 71229 Leonberg, GERMANY  
TEL: 49 (0)7152 6080-0 FAX: 49 (0)7152 608060

### Mitutoyo Deutschland GmbH - Small Tool Sales Division

Heidenheimer Strasse 14, 71229 Leonberg,  
GERMANY  
TEL: 49 (0)7152 9237-0 FAX: 49 (0)7152 9237-29

## U.K.

### Mitutoyo (UK) Ltd. HQ

Joule Road, West Point Business Park, Andover,  
Hampshire SP10 3UX, UNITED KINGDOM  
TEL: 44 (0)1264 353123 FAX: 44 (0)1264 354883

### Coventry M³ Solution Centre

Unit6, Banner Park, Wickmans Drive, Coventry,  
West Midlands CV4 9XA, UNITED KINGDOM  
TEL: 44 (0)2476 426300

### Halifax M³ Solution Centre

Lowfields Business Park, Navigation Close, Elland,  
West Yorkshire HX5 9HB, UNITED KINGDOM  
TEL: 44 (0)1422 375566

### East Kilbride M³ Solution Centre

The Bairds Building, Rankine Avenue, Scottish  
Enterprise Technology Park, East Kilbride G75  
0QF, UNITED KINGDOM  
TEL: 44 (0)1355 581170

## France

### Mitutoyo France

Paris Nord 2-123 rue de la Belle Etoile, BP 59267  
ROISSY EN FRANCE 95957 ROISSY CDG  
CEDEX, FRANCE  
TEL: 33 (0)149 38 35 00

### M³ Solution Center LYON

Parc Mail 523, cours du 3ème millénaire, 69791  
Saint-Priest, FRANCE  
TEL: 33 (0)149 38 35 70

### M³ Solution Center STRASBOURG

Parc de la porte Sud, Rue du pont du péage,  
67118 Geispolsheim, FRANCE  
TEL: 33 (0)149 38 35 80

### M³ Solution Center CLUSES

290 Avenue des Lacs, 74950 Scionzier, FRANCE  
TEL: 33 (0)1 49 38 35 90

### M³ Solution Center TOULOUSE

Aeroparc Saint Martin Cellule B08 ZAC de Saint  
Martin du Touch 12 rue de Caulet 31300 Toulouse,  
FRANCE  
TEL: 33 (0)1 49 38 42 90

---

**M³ Solution Center RENNES**

2, rue Claude Chappe, PA le Vallon - ZAC Mivoie,  
35230 Noyal-Châtillon-sur-Seiche, FRANCE  
TEL: 33 (0)1 49 38 42 10

**Italy****Mitutoyo Italiana S.r.l.**

Corso Europa, 7 - 20045 Lainate (MI), ITALY  
TEL: 39 02 935781

FAX: 39 02 93578255

**M³ Solution Center BOLOGNA**

Via dei Carpini 1/A - 40011 Anzola Emilia (BO),  
ITALY

TEL: 39 02 93578215 FAX: 39 02 93578255

**M³ Solution Center CHIETI**

Contrada Santa Calcagna - 66020 Rocca S.  
Giovanni (CH), ITALY

TEL: 39 02 93578280 FAX: 39 02 93578255

**M³ Solution Center PADOVA**

Via G. Galilei 21/F - 35035 Mestrino (PD), ITALY  
TEL: 39 02 93578268 FAX: 39 02 93578255

**Netherlands****Mitutoyo Nederland B.V.**

Storkstraat 30, 3905 KX Veenendaal,  
THE NETHERLANDS

TEL: 31(0)318-534911

**Mitutoyo Nederland B.V. / M³ Solution Center Enschede**

Institutenweg 50, 7521 PK Enschede,  
THE NETHERLANDS

TEL: 31(0)318-534911

**Mitutoyo Nederland B.V. / M³ Solution Center Eindhoven**

De Run 1115, 5503 LB Veldhoven,  
THE NETHERLANDS

TEL: 31(0)318-534911

**Mitutoyo Research Center Europe B.V.**

De Rijn 18, 5684 PJ Best, THE NETHERLANDS  
TEL: 31(0)499-320200 FAX: 31(0)499-320299

**Belgium****Mitutoyo Belgium N.V. / M³ Solution Center Melsele**

Schaarbeekstraat 20, B-9120 Melsele, BELGIUM  
TEL: 32 (0)3-2540444

**Sweden****Mitutoyo Scandinavia AB**

Släntvägen 6, 194 61 Upplands Väsby, SWEDEN  
TEL: 46 (0)8 594 109 50

**Mitutoyo Scandinavia AB / M³ Solution Center Alingsås**

Ångsvaktaregatan 3A, 441 38 Alingsås, SWEDEN  
TEL: 46 (0)8 594 109 50

**Mitutoyo Scandinavia AB / M³ Solution Center Värnamo**

Kalkstensvägen 7, 331 44 Värnamo, SWEDEN  
TEL: 46 (0)8 594 109 50

**Switzerland****Mitutoyo (Schweiz) AG**

Steinackerstrasse 35, 8902 Urdorf,  
SWITZERLAND

TEL: 41 (0)447361150

**Mitutoyo (Suisse) SA**

Rue Galilée 4, 1400 Yverdon-les Bains,  
SWITZERLAND

TEL: 41 (0)244259422

**Poland****Mitutoyo Polska Sp.z o.o.**

Ul.Graniczna 8A, 54-610 Wroclaw, POLAND

TEL: 48 (0)71354 83 50 FAX: 48 (0)71354 83 55

**Czech Republic****Mitutoyo Česko s.r.o.**

Dubská 1626, 415 01 Teplice, CZECH REPUBLIC  
TEL: 420 417-514-011 Email: info@mitutoyo.cz

**Mitutoyo Česko s.r.o. M³ Solution Center Ivančice**

Ke Karlovu 62/10, 664 91 Ivančice, CZECH REPUBLIC  
TEL: 420 417-514-011 Email: info@mitutoyo.cz

**Mitutoyo Česko s.r.o. M³ Solution Center Ostrava Mošnov**

Mošnov 314, 742 51 Mošnov, CZECH REPUBLIC  
TEL: 420 417-514-050 Email: info@mitutoyo.cz

**Mitutoyo Česko s.r.o. Slovakia Branch**

Hviezdoslavova 124, 017 01 Povážská Bystrica,  
SLOVAKIA  
TEL: 421 948-595-590 Email: info@mitutoyo.sk

---

## Hungary

### Mitutoyo Hungária Kft.

Galamb József utca 9, 2000 Szentendre,  
HUNGARY  
TEL: 36 (30) 6410210

## Romania

### Mitutoyo Romania SRL

1A Drumul Garii Odai Street, showroom, Ground  
Floor, 075100 OTOPENI-ILFOV, ROMANIA  
TEL: 40 (0)311012088 FAX: +40 (0)311012089

### Showroom in Brasov

Strada Ionescu Crum Nr.1, Brasov Business Park  
Tumul 1, Mezanin, 500446 Brasov-Judetul Brasov,  
ROMANIA  
TEL/FAX: 40 (0)371020017

## Finland

### Mitutoyo Scandinavia AB Finnish Branch

Vihertiittäjä 2A, 33960, Pirkkala, FINLAND  
TEL: 358 (0)40 355 8498

## Austria

### Mitutoyo Austria GmbH

Salzburger Straße 260 / 3 A-4600 Wels, AUSTRIA  
TEL: 43 (0)7242 219 998

### Mitutoyo Austria GmbH Goetzis Regional showroom

Lastenstrasse 48a, 6840 Götzis, AUSTRIA

## Singapore

### Mitutoyo Asia Pacific Pte. Ltd.

#### Head office / M<sup>3</sup> Solution Center

24 Kallang Avenue, Mitutoyo Building,  
SINGAPORE 339415  
TEL: (65)62942211 FAX: (65)62996666

## Malaysia

### Mitutoyo (Malaysia) Sdn. Bhd.

#### Kuala Lumpur Head Office / M<sup>3</sup> Solution Center

Mah Sing Integrated Industrial Park, 4, Jalan Utarid  
U5/14, Section U5, 40150 Shah Alam, Selangor,  
MALAYSIA  
TEL: (60)3-78459318 FAX: (60)3-78459346

#### Penang Branch office / M<sup>3</sup> Solution Center

30, Persiaran Mahsuri 1/2, Sunway Tunas, 11900  
Bayan Lepas, Penang, MALAYSIA  
TEL: (60)4-6411998 FAX: (60)4-6412998

### Johor Branch office / M<sup>3</sup> Solution Center

70 (Ground Floor), Jalan Molek 1/28, Taman Molek,  
81100 Johor Bahru, Johor, MALAYSIA  
TEL: (60)7-3521626 FAX: (60)7-3521628

## Thailand

### Mitutoyo (Thailand) Co., Ltd.

#### Bangkok Head Office / M<sup>3</sup> Solution Center

76/3-5, Chaengwattana Road, Kwaeng  
Anusaowaree, Khet Bangkaen, Bangkok 10220,  
THAILAND

TEL: (66)2080 3500 FAX:(66)2521 6136

#### Chonburi Branch / M<sup>3</sup> Solution Center

7/1, Moo 3, Tambon Bowin, Amphur Sriracha,  
Chonburi 20230, THAILAND

TEL: (66)2080 3563 FAX:(66)3834 5788

#### ACC Branch / M<sup>3</sup> Solution Center

122/8, 122/9, Moo 6, Tambon Donhuaroh, Amphur  
Muangchonburi, Chonburi 20000, THAILAND

TEL: (66)2080 3565

## Indonesia

### PT. Mitutoyo Indonesia

#### Head Office / M<sup>3</sup> Solution Center

Jalan Sriwijaya No.26 Desa cibatu Kec. Cikarang  
Selatan Kab. Bekasi 17530, INDONESIA  
TEL: (62)21-2962 8600 FAX: (62)21-2962 8604

#### Batam Branch Office

Business Center Adhya Building 3rd Floor  
Kompleks Permata Niaga Blok A No. 1, Jalan  
jendral Sudirman Kelurahan Sukajadi, Kecamatan  
Batam Kota, Kepulauan Riau 29444, INDONESIA  
TEL: (62)-778-4888000

## Vietnam

### Mitutoyo Vietnam Co., Ltd

#### Hanoi Head Office / M<sup>3</sup> Solution Center

1st & 2nd floor, MHDl Building, No. 60 Hoang  
Quoc Viet Road, Nghia Do Ward, Cau Giay District,  
Hanoi, VIETNAM

TEL: (84)24-3768-8963 FAX: (84)24-3768-8960

#### Ho Chi Minh City Branch Office / M<sup>3</sup> Solution Center

Unit No. B-00.07, Ground Floor, C1 Building, No. 6,  
Street D9, An Loi Dong Ward, Thu Duc City, Ho Chi  
Minh City, VIETNAM

TEL: (84)28-3840-3489 FAX: (84)28-3840-3498

---

**Hai Phong City Branch Office**

Room 511, 5th Floor, Thanh Dat 3 Building, No. 4  
Le Thanh Tong Street, May To Ward, Ngo Quyen  
District, Hai Phong City, VIETNAM  
TEL:(84)22-5398-9909

**Philippines****Mitutoyo Philippines, Inc.****Head Office / M<sup>3</sup> Solution Center**

Unit 1B & 2B LTI, Administration Building 1, Annex  
1, North Main Avenue, Laguna Technopark, Binan  
Laguna 4024, PHILIPPINES

TEL/FAX:(63) 49 544 0272

**India****Mitutoyo South Asia Pvt. Ltd. Head Office**

C-122, Okhla Industrial Area, Phase-I, New  
Delhi-110 020, INDIA

TEL: (91) 11-40578485/86

**MSA Technical Center**

Plot no. 65, Ground Floor, Udyog Vihar, Phase-4  
Gurgaon, Haryana - 122016, INDIA

TEL: (91) 124-2340286/287

**Mumbai Region Head office**

303, Sentinel Hiranandani Business Park Powai,  
Mumbai-400 076, INDIA

TEL: (91) 22-25700684/685/837/839

**Pune Office / M<sup>3</sup> Solution Center**

G4/G5, Pride Kumar Senate, Off. Senapati Bapat  
Road, Pune-411 016, INDIA

TEL:(91) 20-25660043/44/45

**Ahmedabad Office / M<sup>3</sup> Solution Center**

A-104 & A-105, First Floor, Solitaire Corporate  
Park, Near Divya Bhaskar Press, S.G. Road,  
Ahmedabad - 380 015, INDIA

TEL: (91) 079 - 29704902/903

**Bengaluru Region Head office / M<sup>3</sup> Solution Center**

116/117-2, Ground Floor, Sy. No. 93 & 94, 3rd  
Phase, Peenya Industrial Area, Bengaluru-560  
058, INDIA

TEL: (91) 80-25630946/47/48/49

**Coimbatore Office**

Regus, Srivari Srimath, 3rd Floor, Door No:1045,  
Avinashi Road, Coimbatore - 641 018,INDIA

TEL: (91) 9345005663

**Chennai Office / M<sup>3</sup> Solution Center**

No. 624, Anna Salai Teynampet, Chennai-600 018,  
INDIA

TEL: (91) 44-24328823/24/25

**Kolkata Office**

Unit No. 1208,Om Tower, 32,J.L.Nehru Road,  
Kolkata-700 071, INDIA

TEL: (91) 33-22267088/40060635/22266817

**Taiwan****Mitutoyo Taiwan Co., Ltd. / M<sup>3</sup> Solution Center Taipei**

4F., No.71, Zhouzi St., Neihu Dist.,Taipei City 114,  
TAIWAN

TEL: 886(2)5573-5900 FAX: 886(2)8752-3267

**Taichung Branch / M<sup>3</sup> Solution Center Taichung**

1F., No. 299, Gaotie 1st Rd., Wuri Dist., Taichung  
City 414, TAIWAN

TEL:886(4)2338-6822 FAX:886(4)2338-6722

**Kaohsiung Branch / M<sup>3</sup> Solution Center****Kaohsiung**

1F., No.31-1, Haibian Rd., Lingya Dist., Kaohsiung  
City 802, TAIWAN

TEL: 886(7)334-6168 FAX: 886(7)334-6160

**South Korea****Mitutoyo Korea Corporation****Head Office / M<sup>3</sup> Solution Center**

(Sanbon-Dong, Geumjeong High View Build.),  
6F, 153-8, Ls-Ro, Gunpo-Si, Gyeonggi-Do, 15808  
KOREA

TEL: 82(31)361-4200 FAX: 82(31)361-4201

**Busan Office / M<sup>3</sup> Solution Center**

(3150-3, Daejeo 2-dong) 8,Yutongdanji 1-ro  
49beon-gil, Gangseo-gu, Busan, 46721 KOREA

TEL: 82(51)324-0103 FAX: 82(51)324-0104

**Daegu Office / M<sup>3</sup> Solution Center**

(Galsan-dong, Daegu Business Center), 301-Ho,  
217, Seongseogongdan-ro, Dalseo-gu, Daegu  
42704 KOREA

TEL: 82(53)593-5602 FAX: 82(53)593-5603

**China****Mitutoyo Measuring Instruments (Shanghai) Co., Ltd.**

8th Floor, Tower 1 Lujiazui Jinkong Square  
No.1788/1800 Century Ave., Pudong New District,  
Shanghai 200122, CHINA

TEL: 86(21)5836-0718 FAX: 86(21)5836-0717



---

**Suzhou Office / M<sup>3</sup> Solution Center China (Suzhou)**

1/2 Floor, Building 4, No.175 Songbei Road, Suzhou Free Trade Zone, Suzhou City, Jiangsu 215000, CHINA

TEL: 86(512)6522-1790 FAX: 86(512)6251-3420

**Wuhan Office / M<sup>3</sup> Solution Corner**

Room 1701, Wuhan Wanda Center, No. 96, Linjiang Road, Wuchang District, Wuhan Hubei 430060, CHINA

TEL: 86(27)8544-8631 FAX: 86(27)8544-6227

**Chengdu Office**

Room 1-102, 1st Floor, Unit 1, Building 1, No. 24, Wannian Road (Wanniancang Cool), Chenghua District, Chengdu City, Sichuan 610056, CHINA

TEL: 86(28)8671-8936 FAX: 86(28)8671-9086

**Hangzhou Office**

Room 804, Eastern International Business Center Building 1, No.600 Jinsha Road of Hangzhou Economic and Technological Development Zone, 310018, CHINA

TEL: 86(571)8288-0319 FAX: 86(571)8288-0320

**Tianjin Office / M<sup>3</sup> Solution Center China (Tianjin)**

Room D 12/F, TEDA Building, No.256 Jie-fang Nan Road Hexi District, Tianjin 300042, CHINA

TEL: 86(22)5888-1700 FAX: 86(22)5888-1701

**Changchun Office**

Room 815, 8F, Building A1, Upper East International No.3000 Dongsheng Street, Erdao District, Changchun, Jilin, 130031, CHINA

TEL: 86(431)8192-6998 FAX: 86(431)8192-6998

**Chongqing Office**

Room 1312, Building 3, Zhongyu Plaza, No.86, Hongjin Avenue, Longxi Street, Yubei District, Chongqing, 400000, CHINA

TEL: 86(23)6595-9950 FAX: 86(23)6595-9950

**Qingdao Office**

Room 638, 6F, No.192 Zhengyang Road, Chengyang District, Qingdao, Shandong, 266109, CHINA

TEL: 86(532)8096-1936 FAX: 86(532)8096-1937

**Xi'an Office**

Room 805, Xi'an International Trade Center, No. 196 Xiaozhai East Road, Xi'an, 710061, CHINA

TEL: 86(29)8538-1380 FAX: 86(29)8538-1381

**Dalian Office / M<sup>3</sup> Solution Center China (Dalian)**

Room A-106 Shuijing SOHO, No.16 Harbin Road, Economic Development Zone, Dalian, 116600 CHINA

TEL: 86(411)8718 1212 FAX: 86(411)8754-7587

**Zhengzhou Office**

Room1801,18/F,Unit1, Building No.23, Shangwu Inner Ring Road, Zhengdong New District, Zhengzhou City, Henan 450018, CHINA

TEL: 86(371)6097-6436 FAX: 86(371)6097-6981

**Dongguan Office / M<sup>3</sup> Solution Center China (Dongguan)**

Room 801, No 65, Chang'an Section Guanchang Road, Chang'an Town, Dongguan City, Guangdong 523841, CHINA

TEL: 86(769)8541 7715 FAX: 86(769)-8541 7745

**Fuzhou Office**

Unit 03, 7th floor of East Tower, Sansheng International Center, No.118 Wusi Road, Gulou Distrit, Fuzhou City, Fujian 350001, CHINA

TEL: 86 (591) 8761 8095 FAX: 86 (591) 8761 8096

**Changsha Office**

Room 2207, Building 1, Shiner International Plaza, No. 88, Kaiyuan Middle Road, Changsha City, Hunan 410100, CHINA

TEL: 86 (731) 8401 9276 FAX: 86 (731) 8401 9376

**Changzhou Office**

Room 1502, Joint Financial Tower, No.255, Tongjiang North Road, Tianning District, Changzhou City, Jiangsu 2130002, CHINA

TEL:86(519)8815 8319 FAX:86(519)8815 8319

**Wenzhou Office**

Room 512, Building 4, Xinjingdujiayuan, Sanyang Street, Ouhai District, Wenzhou City, Zhejiang 325014, CHINA

TEL: 86(577)8641 5280

**Shunde Office**

Room 1603, Building 26, Vanke Golden Riverside Plaza Phase II, No.13 Mid DeSheng Road, ShunDe District, Foshan City, Guangdong 528300, CHINA

TEL/FAX: 86(757)2228 8621

**Mitutoyo Measuring Technology (Suzhou) Co., Ltd.**

1/2 Floor, Building 4, No.175 Songbei Road, Suzhou Free Trade Zone, Suzhou City, Jiangsu 215000, CHINA

TEL: 86(512)6252-2660 FAX: 86(512)6252-2580

---

## U.S.A.

### Mitutoyo America Corporation

965 Corporate Blvd., Aurora, IL 60502, U.S.A.  
TEL: 1-(630)820-9666  
Toll Free No. 1-888-648-8869  
FAX: 1-(630)978-3501

### Headquarters (Aurora) / M<sup>3</sup> Solution Center

965 Corporate Blvd., Aurora, IL 60502, U.S.A.  
**Seattle (Renton) Office / M<sup>3</sup> Solution Center**  
1000 SW 34th St. Suite G, Renton, WA 98057  
U.S.A.  
TEL: 1-(888)-648-8869

### Houston Office / M<sup>3</sup> Solution Center

4560 Kendrick Plaza Drive Suite 120 Houston, TX  
77032, U.S.A.

TEL: 1-(888)-648-8869 FAX: 1-(281)227-0937

### Cincinnati (Mason) Office / M<sup>3</sup> Solution Center

6220 Hi-Tek Ct., Mason, OH 45040, U.S.A.  
TEL: 1-(888)-648-8869 FAX: 1-(513)754-0718

### Detroit (Novi) Office / M<sup>3</sup> Solution Center

46850 Magellan Drive, Suite 100 Novi, MI 48377,  
U.S.A.

TEL: 1-(888)-648-8869 FAX: 1-(248)-926-0928

### Los Angeles (City of Industry) Office / M<sup>3</sup> Solution Center

16925 E. Gale Ave., City of Industry, CA 91745,  
U.S.A.

TEL: 1-(888)-648-8869 FAX: 1-(626)369-3352

### Charlotte (Huntersville) Office / M<sup>3</sup> Solution Center

11515 Vanstory Dr., Suite 140, Huntersville, NC  
28078, U.S.A.

TEL: 1-(888)-648-8869 FAX: 1-(704)875-9273

### Boston (Marlborough) Office / M<sup>3</sup> Solution Center

753 Forest Street, Suite 110, Marlborough, MA  
01752, U.S.A.

TEL: 1-(888)648-8869 FAX: 1-(508)485-0782

### Mitutoyo America Corporation Calibration Lab

965 Corporate Blvd., Aurora, IL 60502, U.S.A.  
TEL: 1-(888)-648-8869 FAX: 1-(630)978-6477

### Mitutoyo America Corporation CT-Lab Chicago

965 Corporate Blvd., Aurora, IL 60502, U.S.A.  
TEL: 1-(888)-648-8869 FAX: 1-(630)-820-3418

### Mitutoyo Research & Development America, Inc.

11533 NE 118th St., Kirkland, WA 98034-7111,  
U.S.A.  
TEL: 1-(425)821-3906 FAX: 1-(425)821-3228

### Mitutoyo Research & Development America, Inc. - California Office

16925 Gale Ave. City of Industry, CA 91745-1806  
U.S.A.

TEL: 1-(425)821-3906 FAX: 1-(425)821-3228

## Canada

### Mitutoyo Canada Inc.

2121 Meadowvale Blvd., Mississauga, Ont. L5N  
5N1., CANADA

TEL: 1-(905)821-1261 FAX: 1-(905)821-4968

### Montreal Office

7075 Place Robert-Joncas Suite 129, Montreal,  
Quebec H4M 2Z2, CANADA

TEL: 1-(514)337-5994 FAX: 1-(514)337-4498

## Brazil

### Mitutoyo Sul Americana Ltda.

#### Head office / M<sup>3</sup> Solution Center

Avenida Mimes nº 25 – Loteamento Multivias II,  
Jardim Ermdia I, CEP 13212-216 Jundiá – SP,  
BRASIL

TEL: 55 (11) 5643-0004/0041

#### Filial Curitiba / M<sup>3</sup> Solution Center

Rua Sergipe, nº 101, Sala A, Bairro Boneca do  
Iguaçu, São José dos Pinhais – Paraná – BRASIL  
CEP 83040120

TEL: 55 (41) 3534-1728

## Argentina

### Mitutoyo Sul Americana Ltda.

#### Argentina Branch / M<sup>3</sup> Solution Center

Av. B. Mitre 891/899 – C.P. (B1603CQI) Vicente  
López – Pcia. Buenos Aires – ARGENTINA  
TEL: 54 (11) 4730-1433 FAX: 54 (11) 4730-1411

#### Sucursal Cordoba / M<sup>3</sup> Solution Center

Av. Ricchieri 2872 L.4 – Bº Jardim – CP X5014OPJ  
Cordoba, ARGENTINA

TEL: 54 (351) 464-4125

## Mexico

### Mitutoyo Mexicana, S.A. de C.V.

Industria Eléctrica No.15, Parque Industrial,  
Naucalpan de Juárez, Estado de México C.P.53370,  
MÉXICO

TEL: 52 (01-55) 5312-5612

FAX: 52 (01-55) 5312-3380

---

**Monterrey Office / M<sup>3</sup> Solution Center**

Blv. Interamericana No. 103, Parque Industrial  
FINSA, C.P. 66636 Apodaca, N.L., MÉXICO  
TEL: 52(01-81) 8398-8227/8228/8242/8244  
FAX: 52(01-81) 8398-8226

**Tijuana Office / M<sup>3</sup> Solution Center**

Calle José María Velasco 10501-C, Col. Cd.  
Industrial Nueva Tijuana, C.P. 22500 Tijuana, B.C.,  
MÉXICO  
TEL: 52 (01-664) 647-5024

**Querétaro Office / M<sup>3</sup> Solution Center**

Av. Cerro Blanco No.500-1, Colonia Centro Sur,  
Querétaro, Querétaro, C.P. 76090, MÉXICO  
TEL: 52 (01-442) 340-8018, 340-8019 and 340-  
8020  
FAX: 52 (01-442) 340-8017

**Mitutoyo Mexicana, S.A. de C.V. Querétaro  
Calibration Laboratory**

Av. Cerro Blanco 500 30 Centro Sur, Querétaro,  
Querétaro, C.P. 76090, MÉXICO  
TEL: 52 (01-442) 340-8018, 340-8019 and 340-  
8020  
FAX: 52 (01-442) 340-8017

**Aguascalientes Office / M<sup>3</sup> Solution Center**

Av. Aguascalientes No. 622, Local 15 Centro  
Comercial El Cilindro Fracc. Pulgas Pandas Norte,  
C.P. 20138, Aguascalientes, Ags. MÉXICO  
TEL: 52 (01-449) 174-4140 and 174-4143

**Irapuato Office / M<sup>3</sup> Solution Center**

Boulevard a Villas de Irapuato No. 1460 L.1 Col.  
Ejido Irapuato C.P. 36643 Irapuato, Gto., MÉXICO  
TEL: 52 (01-462) 144-1200 and 144-1400

---

## Revision History

<b>Date of publication</b>	<b>No. of revisions</b>	<b>Revision details</b>
July 1, 2017	Second edition	Completely revised
February 1, 2019	Third edition	Change in specifications / Change in notations and expressions
December 1, 2020	Fourth edition	Revision due to changes of the harmonized European standards, etc.
August 1, 2021	Fifth edition	Additions and changes due to application of the UKCA (UK Conformity Assessed) marking
January 1, 2024	sixth edition	Revision due to changes of the harmonized European standards, etc.

# Mitutoyo Corporation

---

20-1, Sakado 1-Chome, Takatsu-ku, Kawasaki-shi, Kanagawa 213-8533, Japan

Tel: +81 (0)44 813-8230 Fax: +81 (0)44 813-8231

Home page: <https://www.mitutoyo.co.jp/global.html>

For the EU Directive, Authorized representative and importer in the EU:

Mitutoyo Europe GmbH

Borsigstrasse 8-10, 41469 Neuss, Germany

For the UK Regulation, Authorized representative and importer in the UK:

Mitutoyo (UK) Ltd.

Joule Road, West Point Business Park, Andover, Hampshire SP10 3UX,  
UNITED KINGDOM

Printed in Japan