

Linear Gage LG200



Read this document thoroughly before operating the product. After reading, retain it close at hand for future reference.

This product is intended to be used in combination with a counter. Be sure to read the counter user's manual as well as this User's Manual for the Linear Gage.

Safety Precautions

When using this product, be sure to observe all precautions regarding indicated specifications, functions and use. Using this product in any other manner may be detrimental to safety. In the event that the product is damaged, take all appropriate measures to avoid accidents and maintain safety.

NOTICE

Shows risks that could result in property damage.

- Do not disassemble or modify the product. Doing so will void the warranty.
- Avoid dropping the product or subjecting it to extreme forces, such as physical jarring.
- Avoid subjecting the plunger to twisting force or lateral pressure.
- Do not use in the vicinity of high voltage devices. Destruction of electronic components may result. Also avoid use in environments that are exposed to high levels of electrical noise.
- To avoid damage or malfunction, avoid over-tightening the stem.
- Note that the contact point might mar the surface of the workpiece depending on the workpiece material, measuring force exerted on the contact point, and the contact force applied to the workpiece. Before undertaking measurement, make sure that measurement will not affect the appearance or accuracy of the workpiece.
- Malfunction may result if this product's cable is bundled with high current power supply cables for other devices. Keep the product's cable away from power supply lines.

Mitutoyo Corporation
20-1, Sakado 1-Chome,
Takatsu-ku, Kawasaki-shi,
Kanagawa 213-8533, Japan



For the EU Directive

Authorized representative and importer in the EU:
Mitutoyo Europe GmbH
Borsigstrasse 8-10, 41469 Neuss, Germany

- The output connector plug (counter connector) and preamp box are not water resistant. Do not use the product in any location that is exposed to splashing water or oil.
- Do not use the cable or rubber boot if damaged, as damage to the product may result. Either replace the part or request repair.
- The materials that are used in rubber boots and seals are not made for use with a broad range of coolants and chemicals. If these parts show noticeable deterioration, please contact the agent where you purchased the product or a Mitutoyo sales office.

Precautions for Measurement

- For accurate measurement, allow the product to warm up for at least 10 minutes after turning on the power before measuring.
- This product does not guarantee accuracy in the range within 0.2 mm of bottom of stroke (plunger fully extended). Perform Zero setting and Preset setting with the plunger raised at least 0.2 mm above bottom of stroke.

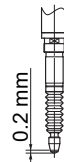

Electromagnetic Compatibility (EMC)

This product complies with the EMC Directive and the UK Electromagnetic Compatibility Regulations; however, if this receives electromagnetic interference that exceeds these requirements, it will be out of warranty and require appropriate measures.

This product is an industrial product, and is not intended to be used in residential environment. If this product is used in residential environment, this product may cause electromagnetic interference with other instruments. In such a case, it is required to take appropriate measures for preventing such electromagnetic interference.

Export Control Compliance

This product falls into the Catch-All-Controlled Goods and/or Catch-All-Controlled Technologies (including Programs) under Category 16 of Appended Table 1 of Export Trade Control Order or under Category 16 of Appended Table of Foreign Exchange Control Order, based on Foreign Exchange and Foreign Trade Act of Japan.

If you intend re-export of the product from a country other than Japan, re-sale of the product in a country other than Japan, or re-providing of the technology (including Programs), you shall observe the regulations of your country.

For the UK Regulation



Authorized representative and importer in the UK:
Mitutoyo (UK) Ltd.
Joule Road, West Point Business Park, Andover,
Hampshire SP10 3UX, UNITED KINGDOM

Disposal of Old Electrical & Electronic Equipment (Applicable in the European Countries with separate collection systems)



This symbol on the product or on its packaging is based on WEEE Directive (Directive on Waste Electrical and Electronic Equipment), and this symbol indicates that this product shall not be treated as household waste.

To reduce the environmental impact and minimize the volume of landfills, please cooperate in reuse and recycle.

For how to dispose of the product, please contact the agent where you purchased the product or a Mitutoyo sales office.

China RoHS Compliance Information

This product meets China RoHS requirements. See the table below.

产品中有害物质的名称及含量

| 部件名称 | 有害物质 | | | | | |
|------|------|------|------|----------|-------|--------|
| | 铅 | 汞 | 镉 | 六价铬 | 多溴联苯 | 多溴二苯醚 |
| | (Pb) | (Hg) | (Cd) | (Cr(VI)) | (PBB) | (PBDE) |
| 本体 | × | ○ | ○ | ○ | ○ | ○ |
| 配件 | ○ | ○ | ○ | ○ | ○ | ○ |

本表格依据 SJ/T 11364 的规定编制。

○：表示该有害物质在该部件所有均质材料中的含量均在 GB/T 26572 规定的限量要求以下。

×：表示该有害物质至少在该部件的某一均质材料中的含量超出 GB/T 26572 规定的限量要求。



环保使用期限标识是根据《电器电子产品有害物质限制使用管理办法》以及《电子电气产品有害物质限制使用标识要求 (SJ/T11364-2014)》制定的，适用于中国境内销售的电子电气产品的标识。

电器电子产品只要按照安全及使用说明内容在正常使用情况下，从生产日期算起，在此期限内产品中含有的有毒有害物质不致发生外泄或突变，不致对环境造成严重污染或对其人身、财产造成严重损害。

产品使用后，要废弃在环保使用年限内或者刚到年限的产品，请根据国家标准采取适当的方法进行处置。

另外，此期限不同于质量/功能的保证期限。

1. Overview

This product is a precision measuring instrument (Linear Gage) that outputs linear variations as differential square waves. To measure changes in length, the Linear Gage is connected to a Mitutoyo Linear Gage counter or programmable logic controller (PLC).

1.1. Connectible Counters

| Model number of connectible counter | Number of gages connectible | Adapter plug (optional) | Specifications |
|-------------------------------------|-----------------------------|-------------------------|--|
| EJ-102N | 2 | Not required | Linkable (eight counters) DIN rail mounting |
| EH-102P | | Required | Standard 2-axis type |
| EH-101P | 1 | Part No. 21HZA195 | Standard 1-axis type |

Tips

- This product does not output an origin signal. In use, disable the origin detection function of the counter to which it is connected.
- The optional adapter plug is required for connection to EH Series Linear Gage counters.
- For connection to counters other than the above, see "7.2. Options".

2. Unpacking and Verification of Package Components

Before using the product, verify that the following items are present.

| Name | Quantity |
|---|----------|
| Linear Gage | 1 |
| Contact point replacement key spanner (Part No. 538610) | 1 |
| User's Manual (this document), 99MBC138B | 1 |
| WEEE guide | 1 |
| Warranty | 1 |

3. Name and Size of Parts

| No. | Name | Specification/notes |
|-----|------------------|--|
| ① | Output connector | HR10A-10P-10P (HIROSE) |
| ② | Output cable | Cable length: 0.5 m |
| ③ | Preamp box | |
| ④ | Signal cable | Cable length = Approx. 2.5 m (to output connector) |
| ⑤ | Stem | |
| ⑥ | Rubber boot | |
| ⑦ | Plunger | Contact point mounting thread: M2.5 x 0.45 |
| ⑧ | Contact point | Carbide ball $\phi 3$ |

Unit: mm

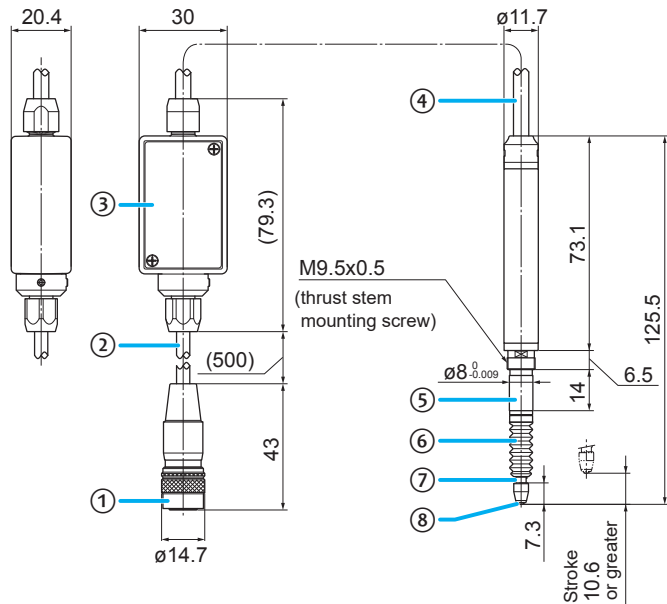

4. Clamping Procedure

When mounting the Linear Gage, it must be clamped to a tool or jig with the stem.

The Linear Gage can be clamped to the tool or jig using either a split clamp or a thrust stem (optional).

NOTICE

Shows risks that could result in property damage.



The following clamping methods can damage the Linear Gage or cause improper operation. Do not use any of these methods.

- Fastening any part other than the stem
- Applying clamping force so great that the stem is deformed
- Clamping the stem directly with a mounting screw



When fastening the stem, use a tightening torque of approximately 0.4 N•m–0.5 N•m.

IMPORTANT

Mount the Linear Gage parallel to the intended direction of measurement. A tilted gage will result in measurement error.

4.1. Using a Split Clamp

The split clamp can fasten the stem by gripping its outer perimeter.

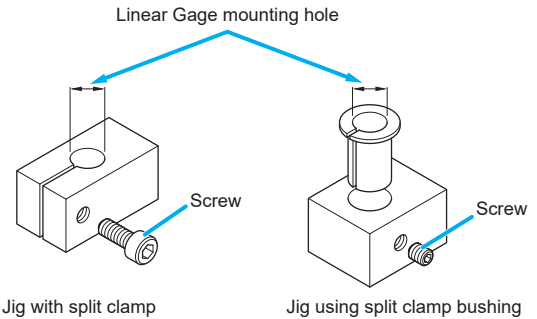

See below for mounting hole dimensions.

| Mounting hole diameter |
|--------------------------------------|
| $\phi 8 \text{ mm } (+0.020/+0.005)$ |

4.2. Using the Optional Thrust Stem

Attach the thrust stem to the Linear Gage and fasten it to the base (tool or jig) with the fastening nut.

NOTICE

Shows risks that could result in property damage.



Fasten the thrust stem using the special-purpose spanner (Part No. 02ADB683) while holding the stem to keep it from moving. Fastening the thrust stem without using the special-purpose spanner may result in application of excessive force between the body and stem, resulting in damage to the Linear Gage.

For the thrust stem, see "7.2.Options".

IMPORTANT

The M9.5 x 0.5 thread on the Linear Gage is used for attaching the thrust stem. Do not use this thread for any purpose other than attaching the thrust stem.

1 Attach the thrust stem to the Linear Gage.

1. Fit the optional special-purpose spanner to the spanner catches (the two grooves) at the base of Linear Gage's stem.
2. Set the thrust stem into the plunger and then turn it with a wrench to fasten it while firmly holding the stem with the special-purpose spanner.

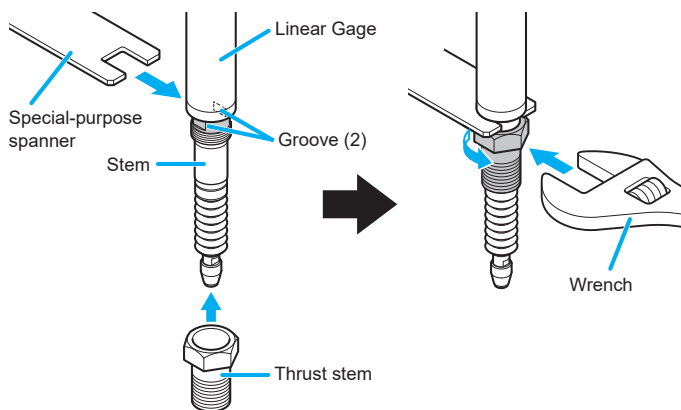

2 Set the Linear Gage that attached the thrust stem into the base (tool or jig).

1. Insert the Linear Gage that attached the thrust stem into the mounting hole on the base (tool or jig).
2. Thread the fastening nut onto the thrust stem from the plunger side, and then securely tighten the fastening nut with one wrench while holding the thrust stem with another wrench to keep it from moving.

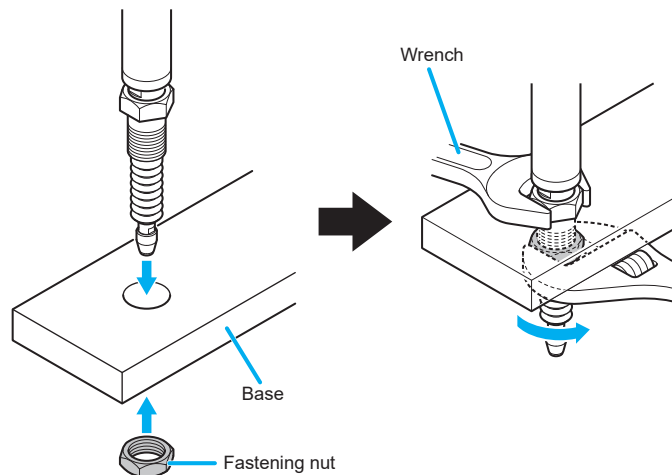

■ Dimensional specifications

Unit: mm

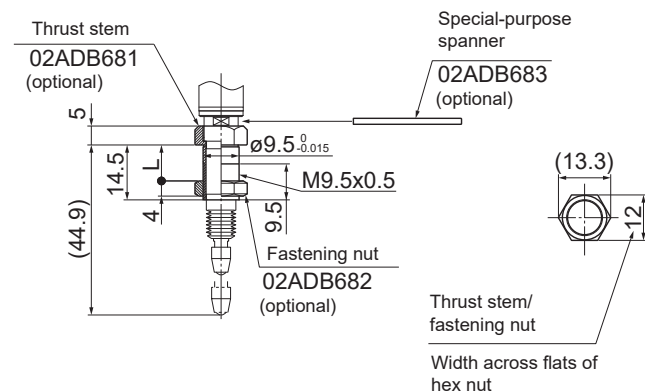

L: base thickness, use the base with a thickness of 6 mm to 10.5 mm.

■ Fastening the cable

When movement of a Linear Gage attached to the tool or jig causes repeated flexing of the cable, make sure that the cable is fixed in a manner that maintains a bending radius of at least 100 mm.

NOTICE

Shows risks that could result in property damage.



- Fix the cable to the tool or jig so that it does not put any strain on the Linear Gage or preamp box.
- Do not bend the cable more than the cable's rated bending radius. Bends that are too tight can result in broken cable wires. The bending radius is not warranted.

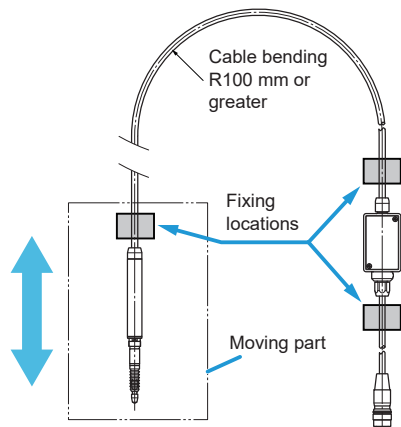

- When the cable doesn't move,
→ **Cable bending radius = 50 mm or greater**

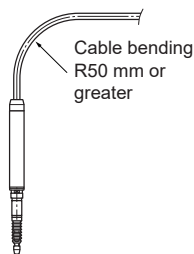

5. Output Signals

This section explains the signals output by the Linear Gage.

NOTICE

Shows risks that could result in property damage.



- Malfunction may result if this product's cable is bundled with high current power supply cables for other devices. Keep the product's cable away from power supply lines.
- Electrical noise can interfere with proper operation; use a stable, noise-free power source.
- When using this product with a counter other than one made by Mitutoyo, reset the counter not sooner than 0.5 second after powering on the Linear Gage.

5.1. Output Connector and Signal Level

- Output connector: HR10A-10P-10P (HIROSE)
- Signal level: TD62583 line driver (AM26LS31 equivalent)
- Pin assignments:

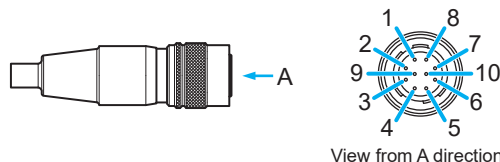

| Pin No. | Signal name | Pin No. | Signal name |
|---------|------------------------|---------|-------------|
| 1 | PA | 7 | N.C |
| 2 | $\overline{\text{PA}}$ | 8 | N.C |
| 3 | N.C | 9 | +5V |
| 4 | PB | 10 | GND |
| 5 | $\overline{\text{PB}}$ | Shell | FG |
| 6 | N.C | | |

- Linear Gage power supply
Power supply voltage: 5 V (4.8 V–5.2 V), ripple voltage not greater than 0.2 Vpp
Maximum power consumption: 80 mA (using recommended circuit connection)
- Compatible receptacle and jack
Receptacle: HR10A-10R-10S (HIROSE)
Jack: HR10A-10J-10S (HIROSE)

Recommended circuit

LG200 output circuit

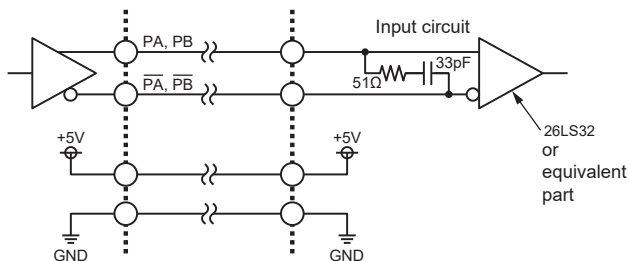

IMPORTANT

Always use a line driver IC or differential amplifier circuit for signal generation. Lack of differential amplification will make the signal vulnerable to noise.

5.2. Output Signal Chart

This product provides the following two output signal patterns. During circuit design, make sure that the receive circuit provides for error detection.

Normal output (when the plunger is pressed in)

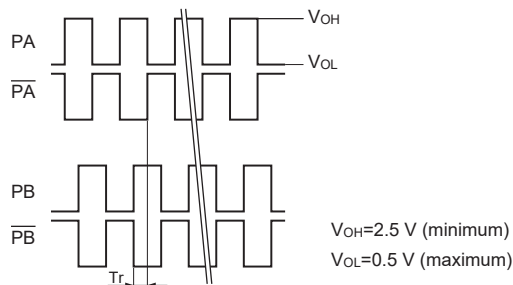

- Output condition: Speed of plunger movement \leq Linear Gage response speed^{*1*2}
- Tr: Output pulse edge interval (normal output; see table in panel 12.)
- Output delay time^{*3}: Not more than 1 μ s

Error output

When an error occurs, PA, \overline{PA} , PB, and \overline{PB} are output in phase.

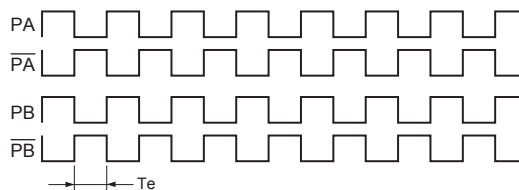

- Output conditions: The Linear Gage enters the error state and the special pattern indicated in the figure above is output under the following conditions:
Speed of plunger movement > Linear Gage response speed^{*1*2}
- Te: Output pulse edge interval (error output; see table below)
Minimum edge interval under different conditions

| Resolution | Tr (normal condition) | Te (error condition) |
|-------------|-----------------------|----------------------|
| 1 μ m | 500 ns | 500 ns |
| 0.5 μ m | 250 ns | |
| 0.1 μ m | | |

^{*1} Even if output conditions (speed) are met, errors might be output because of slight speed fluctuations caused by vibration or the influence of noise. Error output while in the stopped state may indicate an instrument fault.

^{*2} For Linear Gage response speed, see "7. Specifications".

^{*3} Indicates the time required for the counter pulse to catch up with the plunger position.

IMPORTANT

- The error output cannot be used as counter data. Provide for error detection on the receive circuit side.
- Use of an IC capable of counting at 5 MHz or higher is recommended (for a square wave frequency of 1.25 MHz).

6. Maintenance

6.1. Replacing the Contact Point

NOTICE

Shows risks that could result in property damage.



When replacing the contact point, always use the contact point replacement key spanner to hold the plunger stationary. Application of force through the plunger to the internal sensor can damage the sensor and render the Linear Gage inoperable.

Fit the provided contact point replacement key spanner to the spanner catches at the tip of the plunger and hold the spanner to prevent the plunger from turning (see figure at right); then cover the contact point with soft cloth and grip with pliers to remove it.

Reverse the procedure to install the replacement contact point.

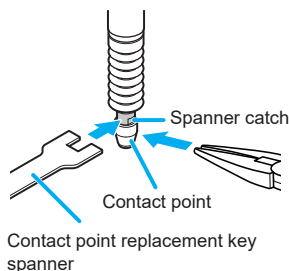

IMPORTANT

- After attaching the contact point, make sure that it is not loose.
- Note that change of the contact point may change external dimensions and measuring force and limits movement in the direction of measurement. Also note that instrument error resulting from change of the contact point (perpendicularity, for example when replaced with a flat contact point) will have a cumulative effect on measurement accuracy.

6.2. Replacing the Rubber Boot (Part No. 21HAA331)

NOTICE

Shows risks that could result in property damage.

Damage to the rubber boot can lead to associated damage. Avoid such damage by preventively replacing the rubber boot.

1 Remove the contact point from the tip of the plunger.

See "6.1 Replacing the Contact Point".

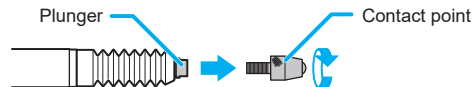

2 Remove the rubber boot, and then use alcohol, etc. to clean all oil and contaminants from the two rubber boot attachment grooves (one on the stem and another at the tip of the plunger).

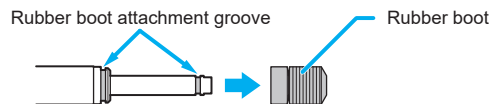

3 Fit the new rubber boot large opening-first onto the plunger.



4 Apply a small amount of silicone-based contact cement to the rubber boot attachment grooves.

NOTICE

Shows risks that could result in property damage.

When doing so, be very careful to avoid getting contact cement on the plunger. Any contact cement on the plunger can damage it or render it inoperable.

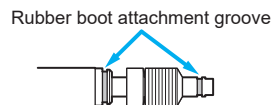

5 Stretch the rubber boot so that both of its ends engage the rubber boot attachment grooves. When installing the rubber boot, make sure that it is not twisted.



6 Reinstall the contact point on the plunger.

See "6.1 Replacing the Contact Point".

6.3. Maintenance

Gently wipe dirt from the product with a soft, lint-free cloth (such as non-woven fabric). Do not use any organic solvents, such as detergent, thinner or benzene.

7. Specifications

7.1. Specifications

■ Common specifications

| | | |
|-------------------------------|-------------------------------------|---|
| Measuring range | | 10 mm |
| Repeatability: 2σ (20 °C) | | 0.3 μm |
| Narrow range accuracy (20 °C) | | 0.5 μm (arbitrary 20 μm range) |
| Measuring force | Contact point oriented downward | 0.8 N or less |
| | Contact point horizontally oriented | 0.75 N or less |
| | Contact point oriented upward | 0.7 N or less |
| Position detection method | | Photoelectric transmission-type linear encoder |
| Contact point | | ø3 mm carbide ball (mounting screw: M2.5×0.45) (Part No.901312) |
| Stem diameter | | ø8 |
| Bearing type | | Linear ball bearing |
| Protection level | | IP67G*1 equivalent (gage head only) |
| Output signal type | | Differential square wave with 90° phase difference (RS-422A equivalent) |
| Power supply voltage | | 5 V DC (4.8 V–5.2 V), ripple voltage not greater than 0.2 Vpp |
| Maximum power consumption | | 80 mA (using recommended circuit connection) |

| | |
|--|---|
| Output connector | Plug used: HR10A-10P-10P (HIROSE) Mating receptacle: HR10A-10R-10S (HIROSE) |
| Cable | Length = Approx. 2.5 m (to output connector), Sheath material: Signal cable=Polyurethane Output cable=Polyvinyl chloride |
| Rubber boot material | HNBR (hydrogenated nitrile butadiene rubber) |
| Operating temperature (humidity) range | 0 °C–50 °C (20%–80 % RH, without condensation) |
| Storage temperature (humidity) range | -10 °C–60 °C (20%–80 % RH, without condensation) |
| Mass | Approx. 210 g |
| Standard accessories | Key spanner for replacing contact point: No.538610 |
| | User's Manual (this document), 99MBC138B |
| CE marking/ UKCA marking | EMC Directive/Electromagnetic Compatibility Regulations: EN IEC 61326-1 Immunity test requirement: Clause 6.2 Table 2 Emission limit: Class A RoHS Directive/The Restriction of the Use of Certain Hazardous Substances in Electrical and Electronic Equipment Regulations: EN IEC 63000 |

*1 IP67G does not provide assurance against immersion in oil or water, or protection against all types of oils.
For details on protection level IP67, see IEC60529 and JIS C0920.
IP6X (protection against foreign matter): Protected against ingress of foreign matter.
IPX7 (protection against water): Protected against ingress of water in quantities that would adversely affect functionality subsequent to momentary immersion for a specified amount of time at a specified pressure.
IPXXG (protection against oil): Protected against ingress of oil due to exposure from any direction.

■ Type-specific specifications

| | | | |
|--|-------------------|-------------------|--------------------|
| Code No. | 542-186 | 542-187 | 542-188 |
| Model No. | LG200-110 | LG200-0510 | LG200-0110 |
| Resolution | 1 μm | 0.5 μm | 0.1 μm |
| Accuracy (at 20 °C) L=Arbitrary measurement length (mm) | 1.5 + L / 50 μm | | 0.8 + L / 50 μm |
| Maximum response speed | 1,500 mm/s | | 400 mm/s |
| Minimum edge interval | 500 ns (2 MHz) | 250 ns (4 MHz) | |
| Output signal pitch | 4 μm | 2 μm | 0.4 μm |

7.2. Options

| Name | Part No. |
|--|----------|
| Rubber boot (for 10 mm measuring range type) | 21HAA331 |
| Thrust stem set (for 10 mm measuring range type*1) | 02ADB680 |
| Thrust stem (individual part) | 02ADB681 |
| Fastening nut (individual part) | 02ADB682 |
| Special-purpose spanner (for thrust stem installation with 10 mm measuring range type) | 02ADB683 |
| Extension cable (5 m)*2 | 21HZA197 |
| Extension cable (10 m)*2 | 21HZA198 |
| Extension cable (20 m)*2 | 21HZA199 |
| Adapter plug (for differential square wave counter) Connectible counters*3: EH-101P (542-075), EH-102P (542-071), EG-101P (542-015), EB-11P (542-092-2), EV-16P (542-063) | 21HZA195 |
| Air Lifter (for use with 10 mm measuring range type) | 02ADE230 |

*1 The thrust stem set includes the thrust stem and thrust stem fastening nut. The special-purpose spanner is also required in order to tighten the thrust stem fastening nut.

*2 Up to three extension cables can be connected, with a maximum combined length of 20 m.

*3 For connection of older counters, please contact a Mitutoyo sales office.

Tips

For replacement contact points (option), see Mitutoyo's Linear Gage catalog or contact the agent where you purchased the product or a Mitutoyo sales office.