

ABS Digimatic Indicator ID-U



Safety Precautions

To ensure operator safety, use this product in conformance with the directions, functions and specifications given in this User's Manual.

Use under other conditions may compromise safety.

WARNING

- Always keep batteries out of reach of children. If swallowed, consult a physician immediately.
- Batteries should never be short-circuited, disassembled, deformed or come in contact with extreme heat or flames.
- If battery alkaline liquid comes in contact with the eyes, flush eyes immediately with clean water and consult a physician. If battery alkaline liquid comes in contact with the skin, flush the exposed area thoroughly with clean water.

CAUTION

Never attempt to charge the primary battery. Never reverse the positive-negative terminals when mounting. Improper battery handling or mounting may cause the battery to explode, cause battery leakage and/or serious bodily injury or malfunctioning.

NOTICE

- Do not disassemble or modify. This may cause damage.
- Do not use or store the product in a place with sudden temperature changes. Adapt the product to ambient temperature before use.
- Do not store the product in a place with high humidity or a lot of dust. Also, avoid usage in places exposed to splashes of water or coolant.
- Do not apply excessive force or subject to sudden impacts such as dropping.
- Be sure to perform reference point setting before measurement.
- Remove dust, cutting chips, etc. before and after use.
- Do not write numbers, etc. with an electric pen. This may cause damage.
- Do not operate the keys with a pointed object (such as a screwdriver or ballpoint pen).
- Avoid loads in the vertical direction relative to the spindle or usage involving torsion to the spindle.
- This product is shipped without a battery. Install a battery before use.
- The battery supplied is for confirming the functions and performance of the product. Note that this battery may not fulfill the expected life.
- When disposing of batteries, follow local laws, regulations, etc.
- Malfunction or damage due to depleted batteries, etc. is not covered by the warranty.

Contents

1. Names and Dimensions of Components	Page 1
2. Installing (Replacing) the Battery	Page 1
3. Setup	Page 1
4. Power ON/OFF	Page 2
5. ORIGIN Setting (Reference Point Setting)	Page 2
6. Measurement Method	Page 2
7. Precautions after Use	Page 3
8. Errors and Troubleshooting	Page 3
9. Output Function	Page 3
10. Specifications	Page 3
11. Accessories (Optional)	Page 3
12. Off-Site Repairs (Subject to Charge)	Page 3

Key icon operation

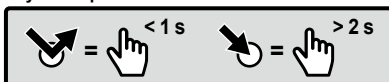

1. Names and Dimensions of Components

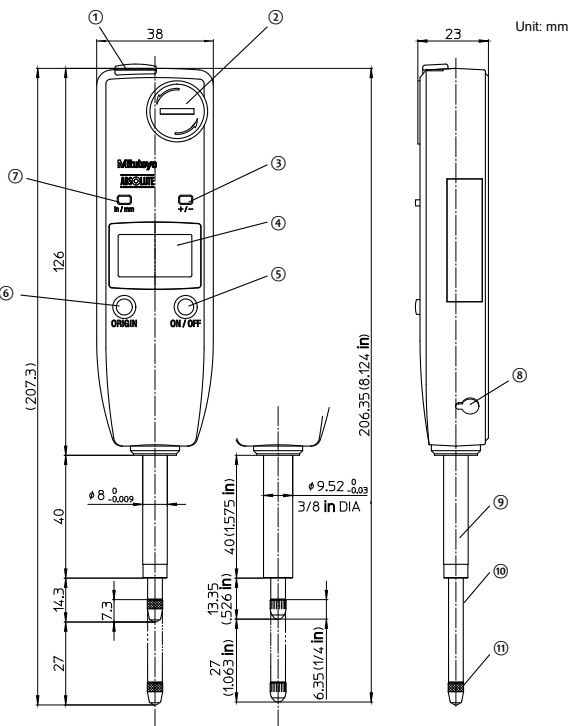

- ① Output connector (with cap)
- ② Battery cap
- ③ [+/-] key
- ④ Display (LCD)
- ⑤ [ON/OFF] key
- ⑥ [ORIGIN] key
- ⑦ [in/mm] key (Code No. 575-122, 575-123 only)
- ⑧ Release mounting hole (with rubber cap)
- ⑨ Stem
- ⑩ Spindle
- ⑪ Contact point

■ Display (LCD)

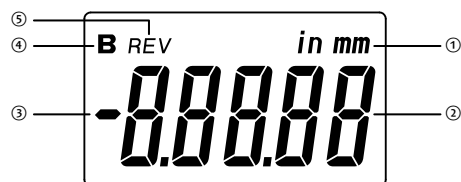

- ① Unit display
- ② Measured value display
- ③ Sign display
- ④ Low battery voltage display
- ⑤ Reverse count display

2. Installing (Replacing) the Battery

NOTICE

- Be sure to use SR44 (silver oxide button battery, part No. 938882) for the battery.
- The product may display an error or malfunction if the battery cap is not mounted correctly.
- If the product will be out of use for 3 months or more, remove the battery and store it separately, to prevent damage to the product due to battery fluid leakage.

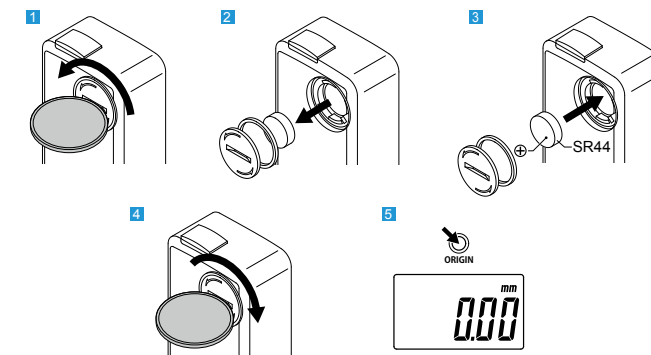

- 1 Insert a coin or similar into the battery cap groove and rotate the cap to remove it.
- 2 If replacing an existing battery, remove the old battery.
- 3 Insert a new battery with the "+" symbol facing the display (LCD).
- 4 Rotate the battery cap to mount it.
- 5 Press the [ORIGIN] key for 1 second or more.

Tips

- If no value is displayed even when a battery is installed, reinstall the battery.
- Although the display may show garbled text or [E] for minimum digits just after installing the battery, this is not abnormal. Perform reference point setting as is (refer to "5. ORIGIN Setting (Reference Point Setting)").
- Reference point settings are cleared when the battery is removed. Perform reference point setting again after installing the battery.

3. Setup

1) Mounting to a stand, jig, etc.

NOTICE

- Whenever possible, avoid fixing the stem directly with a set screw, etc.
- The spindle may not be able to move smoothly if the screw is tightened with a tightening torque of 150 cN·m or more to secure the stem.

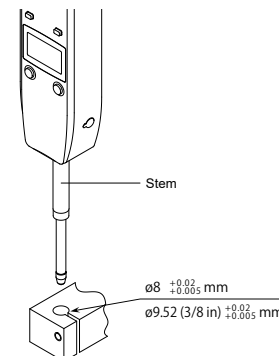

Tips

When mounting the product to a stand or jig, use the stem. If using the stem, use a slotted holder with a $\varnothing 8\ \text{mm}$ (ID-U1025, ID-U1025M) or $\varnothing 9.52\ \text{mm}$ hole with G7 (+0.005 mm to +0.02 mm) (ID-U1025E).

2) Mounting the lifting lever

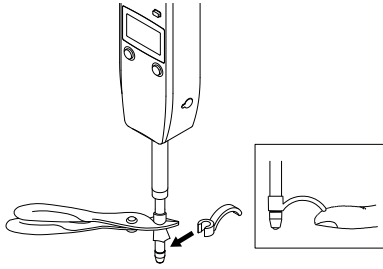

- 1 Fix the spindle, using pliers padded with a rag, etc., from the opposite side so that it does not turn.
- 2 Insert the lifting lever into the spindle.
- 3 Rotate the lifting lever to adjust the orientation.

3) Mounting the release (Optional: part No. 540774)

NOTICE

- Always mount the rubber cap if a release is not mounted.
- The rubber cap is a screw-in type.
- The product may be damaged if an item other than the release is inserted or if excessive force is applied.
- Raising or lowering the spindle while the release is not secured firmly may damage the internal components or the workpiece.

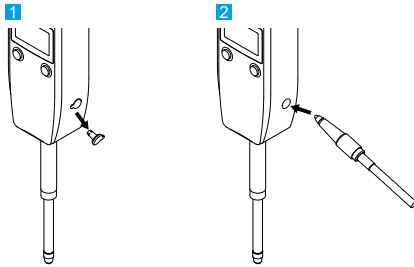

- 1 Remove the rubber cap from the release mounting hole.
- 2 Screw the release firmly into the hole.

Tips

- Store the removed rubber cap to prevent loss.
- The spindle can be moved about 10 mm with the release.

4) Contact point replacement

NOTICE

When replacing the contact point, turn the contact point while fixing the spindle. Otherwise, the product may be damaged.

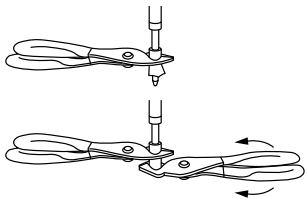

Mount and remove the contact point with a rag and 2 pairs of pliers (one for fixing the spindle) as shown in the figure.

Tips

- Changing the contact point may cause changes in external dimensions and measuring force, or restrictions on the possible measurement directions.
- Errors due to the contact point (perpendicularity of flat contact point, center runout of roller contact point, etc.) are added to the measurement accuracy.
- Various contact points are available as options. Refer to the Measuring Instruments Catalog for details.

4. Power ON/OFF

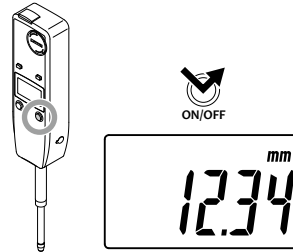

- 1 Press the [ON/OFF] key to turn the product on and off.

Tips

- If the power does not turn on even when the [ON/OFF] key is pressed, the battery may be depleted. Replace the battery.
- Even after the power is turned off, the reference point set and counting direction will be retained.

5. ORIGIN Setting (Reference Point Setting)

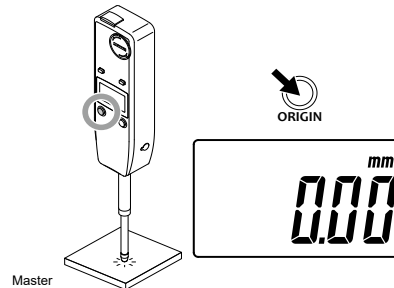

- 1 Move the spindle to the point to be set as the reference point, and then press the [ORIGIN] key for 1 second or more.
⇨ The indicated value becomes 0.00 and the reference point (ORIGIN) is set.

Tips

- Place the contact point on the workpiece several times to verify that the measured value is stable.
- This product does not guarantee stable repeatability within 0.2 mm from the bottom dead center (when the spindle is completely extended). When performing reference point setting, be sure to lift the spindle at least 0.2 mm above the bottom dead center.

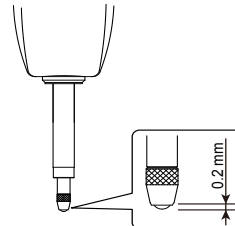

- A rubber damper is attached to this product to soften the spindle impact. Although the indicated value may not be stable at the bottom dead center due to the elasticity of the damper, this is not a malfunction.

6. Measurement Method

1) Measurement

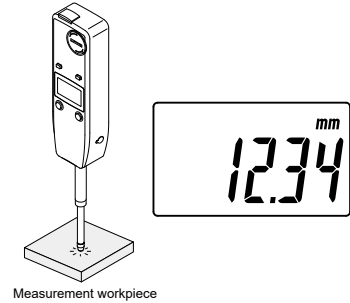

- 1 Gradually and lightly place the contact point on the workpiece in the same orientation and conditions as for reference point setting, and then read the indicated value.

Tips

- If the contact point strikes the workpiece hard, the workpiece may deform and measurement results may be affected.

2) Switching counting direction

The counting direction can be changed by pressing the [+/-] key. If the product is set to negative counting when the spindle is pushed in, [REV] is shown on the top left of the LCD.

● Positive count

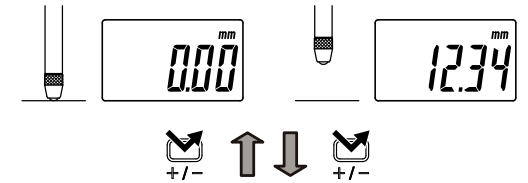

● Negative count

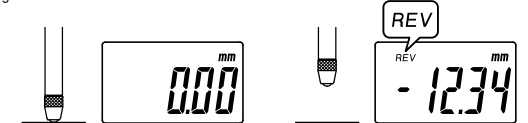

3) Switching units

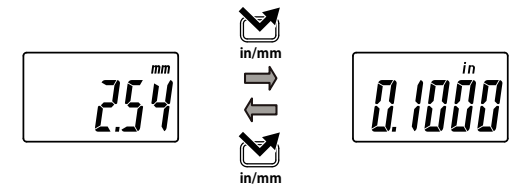

Press the [in/mm] key to switch the unit between in (inches) and mm (millimeters).



7. Precautions after Use

- When cleaning, wipe this product with a soft cloth moistened with diluted neutral detergent. Do not use an organic solvent such as thinner, which may cause the product to deform or malfunction.
- Dirt on the spindle may lead to malfunction. Clean with a cloth moistened with alcohol, etc. before use.
- Do not lubricate the spindle with lubricating oil, etc.
- If the product is to be out of use for 3 months or more, remove the battery before storage. Liquid leakage from the battery may damage the product.
- Do not store the product in a place with a high temperature or humidity, or a lot of dust or oil mist.

8. Errors and Troubleshooting

Error Display	Causes and Countermeasures
Low Battery Voltage 	Battery is depleted. Replace with a new battery.
Sensor Contamination Detection Error 	A sudden change in temperature may create condensation on the detector, or it may be contaminated by other sources. Turn the power off and allow the product to adapt to the temperature for about 2 hours. If it does not recover after adapting to the temperature, repair is required: contact your dealer or agent or our sales office.
ABS Synthesis Error 	Although this may occur during high-speed spindle movement, there is no effect on measurement. Use the product as is. If it occurs while the spindle is not moving, the internal sensor has failed. In this case, repair is required: contact your dealer or agent or our sales office.

9. Output Function

1) Externally outputting the displayed value

The displayed value can be output to a device supporting Digimatic output format by connecting the product and the external device with a connection cable (option). The product can be connected to an optional external display, external printer, PC, etc.

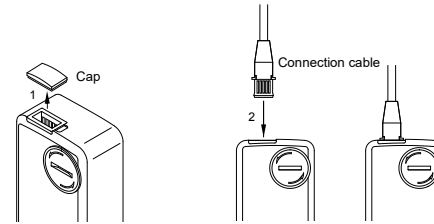

- 1 Press the [ON/OFF] key to turn off the product.
- 2 Connect the product and the external device.
 1. Remove the cap of the output connector of the product.
 2. Connect the product and the external device with a connection cable.

Tips

- 2 types of connection cables (options), part No. 905338 (1 m) and part No. 905409 (2 m), are available for this product.
- When connecting a connection cable, pay attention to the connector direction as you insert it.
- Store the removed cap to prevent loss.
- Always install the cap if a connection cable is not used.

2) Output connector

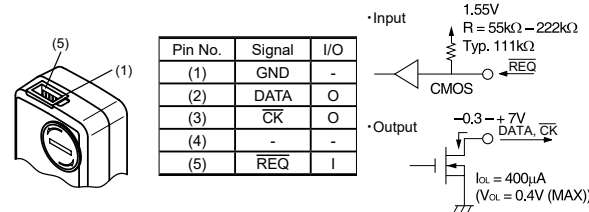

3) Output data format

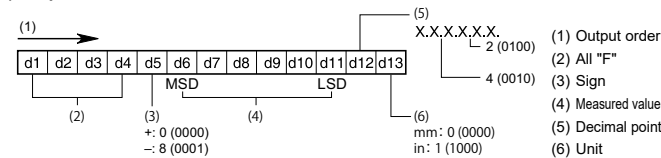

4) Timing chart

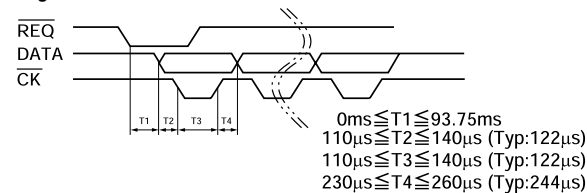

10. Specifications

Model	ID-U1025	ID-U1025M	ID-U1025E
Code No.	575-121	575-122	575-123
Measurement range	25.4 mm	25.4 mm/1 in	
Resolution	0.01 mm	0.01 mm/0.0005 in	
Error of indication for the total measuring range MPE _E *1	0.02 mm	0.02 mm/±0.001 in	
Hysteresis MPE _H *1	0.02 mm	0.02 mm/0.001 in	
Repeatability MPE _R *1	0.01 mm	0.01 mm/0.0005 in	
Stem diameter	8 mm		3/8 in (9.52 mm)
Contact point (equipped as standard)	Carbide (joint part M2.5 x 0.45) Part No. 901312		Carbide (joint part No.4-48 UNF) Part No. 21BZB005
Measuring force MPL	1.8 N or less		
Measurement direction	All directions		
Mass	140 g		150 g
Protection level *2	IP42 equivalent *3		
CE Marking	EMC Directive: EN 61326-1 Immunity test requirement: Clause 6.2 Table 2 Emission limit: Class B RoHS Directive: EN IEC 63000		
Power	Silver oxide battery SR44 x 1 (part No. 938882)		
Battery life *4	Continuous operation approx. 20,000 hours		
Scale type	Electrostatic capacitance type absolute linear encoder		
Response speed	Unlimited (unavailable for scanning measurement)		
Data output	Digimatic code out		
Temperature range	Operating temperature range: 0 °C to 40 °C Storage temperature range: -10 °C to 60 °C		
Standard accessory	SR44 (for function verification x 1), User's Manual with warranty, Lifting lever (part No. 137693)		

*1: During normal measurement at 20 °C.

*2: The protection level (IP: International Protection) is based on IEC 60529/JIS C 0920.

*3: Values are for factory default conditions.

*4: The battery life varies depending on usage times and conditions. The above values are guidelines.

11. Accessories (Optional)

- Release: Part No. 540774
- Connection cable: Part No. 905338 (1 m, flat straight)
- Connection cable: Part No. 905409 (2 m, flat straight)

*For accessories (optional) other than the above, refer to the Measuring Instruments Catalog.

12. Off-Site Repairs (Subject to Charge)

Off-site repair (subject to charge) is required in the case of the following malfunctions. Contact your nearest dealer or our sales office.

- Poor spindle operation
- Poor accuracy
- [E] is displayed as the last digit when the spindle is stationary
- Abnormal measured value or LCD trouble
- No recovery from [Err C]
- Power will not turn on

*If the fundamental structural components or multiple components need to be replaced, we reserve the right to decline the repair.