



Dial Indicator

Safety Precautions

To ensure operator safety, use this product in conformance with the directions, functions and specifications given in this User's Manual. Use under other conditions may compromise safety.

NOTICE Shows risks that could result in property damage.

- Do not disassemble or modify. This may cause damage.
- Do not use or store the product in a place with sudden temperature changes. Adapt the product to room temperature before use.
- Do not store the product in a place with high humidity or a lot of dust.
- Do not move the plunger quickly or apply horizontal force.
- Do not apply excessive force or subject to sudden impacts such as dropping.
- If an impact such as falling is applied, inspect accuracy, etc. before use.
- Remove dust, cutting chips, etc. before and after use.
- Apply anti-rust treatment if the product is used in a place where it is directly exposed to splashes of coolant, etc. Rust may cause malfunction.

Contents

1. Types	Page 1
2. Names of Components	Page 1
3. Preparations before Use	Page 1
4. Measurement Method	Page 2
5. Cleaning after Use	Page 2
6. Specifications	Page 2
7. Accessories (Optional)	Page 2
8. Off-Site Repairs (Subject to Charge)	Page 2

1. Types

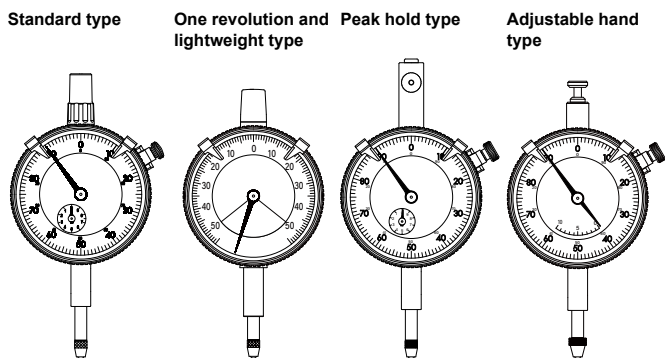

Back plunger type

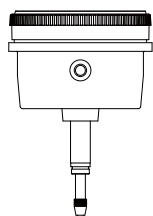

2. Names of Components

Image shows 2046S.

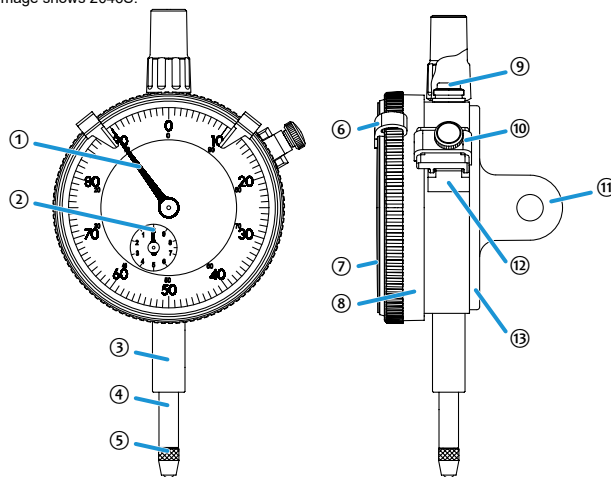

- | | |
|--|--|
| ① Pointer | ⑦ Crystal |
| ② Short pointer (revolution counting device) | ⑧ Bezel |
| ③ Stem | ⑨ Stop screw |
| ④ Plunger | ⑩ Bezel clamp (option for metric type) |
| ⑤ Contact point | ⑪ Lug |
| ⑥ Limit hand (optional) | ⑫ Dovetail |
| | ⑬ Back |

3. Preparations before Use

1) Checking items before use

- Before using the product, confirm that the pointer, short pointer (revolution counting device), and plunger move smoothly. Also, confirm that the long and short pointer (revolution counting device) are stable at the dwell position you have set.
- Use a holder with sufficient rigidity, confirmed with the following procedures. After mounting the dial indicator on it, bring the contact point into contact with a workpiece. Lightly push the bezel with a finger from above or below. The pointer will move. Check whether the pointer returns to the original position.
- For use in a place with fluctuating temperature, frequently check the set position of the pointer with a reference gage such as a master.
- Be sure to use only the product's stem or lug for mounting.
- When using the stem for mounting, be sure not to tighten too much. If the stem is tightened too much, the plunger may not operate well.
- Without oiling the plunger, clean it with a dry cloth or a cloth slightly moistened with alcohol.
- Confirm that the back and contact point are not loosened.
- When removing the stop screw to mount a lifting cable or lifting lever, hold the plunger not to fall. If the plunger falls, the gear engagement with the plunger may be disengaged.

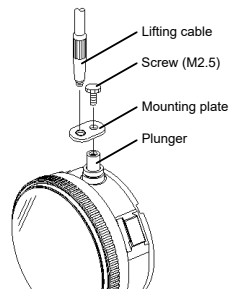

2) Mounting to a stand, jig, etc.

When mounting the product to a stand or jig, use the stem, a lug, or various backs (optional).

NOTICE Shows risks that could result in property damage.

- Whenever possible, avoid fixing the stem directly with a set screw, etc. The plunger may not be able to move smoothly if the screw is tightened with a tightening torque of 150 cN·m or more to secure the stem.
- When using a stem for mounting, do not fix near the lower end of the stem.
- When removing the back to change the direction of the lug, be careful not to let oil or dust get inside.

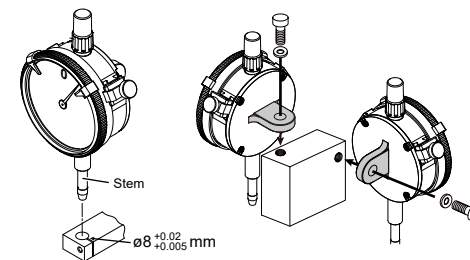

Tips

- If using the stem, use a slotted holder with a ø8 mm (ISO/JIS type) or ø9.52 mm hole with G7 (+0.005 mm to +0.02 mm) (ANSI/AGD type).
- Mount the plunger perpendicular to the surface to be measured.
- The lug orientation can be changed 90° depending on the application.

3) Contact point replacement

Holding the product, apply a soft cloth such as felt to the knurled part of the contact point (if not knurled, to the area near the plunger), and rotate the contact point to loosen it with pliers or longnose pliers.

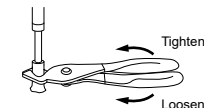

Tips

- Replacing the contact point may cause changes in external dimensions and measuring force, or restrictions on the possible measurement directions.
- Contact point accuracy (perpendicularity of flat contact point, center runout of roller contact point, etc.) is added to the measurement accuracy.
- Various contact points are available as options. Refer to the Measuring Instruments Catalog for details.

4) Releasing the pointer held at the peak point (2046S-80, 2046SB-80 only)

The pointer holds the maximum value position due to the structure that the spindle stays in the pushed position.

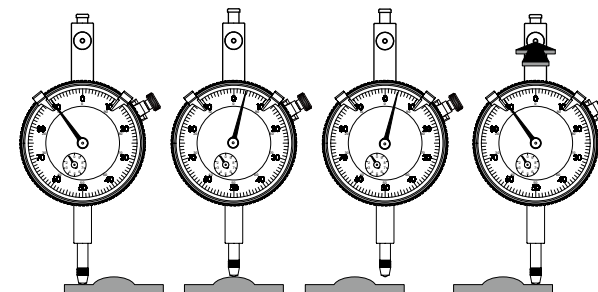

- 1 Press in the arrow direction.
⇒ The pointer held at the peak point will be released.

5) Adjusting the pointer position
(2048S-10, 2048SB-10, 2915S-10, 2915SB-10, 2918S-10, 2918SB-10 only)

By turning the knob on the top, the pointer position can be adjusted without moving the spindle up and down.

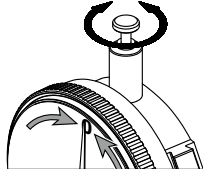

- 1 Turn the upper knob.

6) Mounting the bezel clamp* (*option for metric type)
[excluding one revolution and lightweight type and back plunger type]

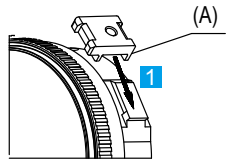

- 1 Fit the clampz bracket (A) into the dovetail.

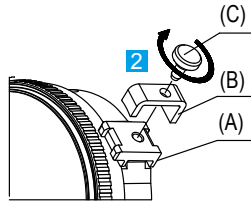

- 2 Tighten the clamp screw (C) while pressing the clamp bracket (A) with the clamp plate (B).

NOTICE Shows risks that could result in property damage.

If using the product horizontally or in a reversed orientation, the clamp screw may loosen and fall off due to vibration, etc.

7) Mounting/removing the limit hand* (*optional)

- Detaching the limit hand

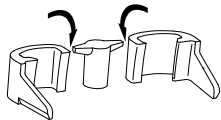

- 1 Detach the limit hand.

NOTICE Shows risks that could result in property damage.

When detaching the limit hand, be careful not to injure yourself on the detached part.

- Mounting

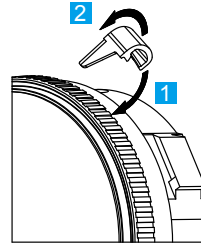

- 1 Hook the limit hand on the bezel.
- 2 Push the limit hand until a click sound is heard.

- Removing

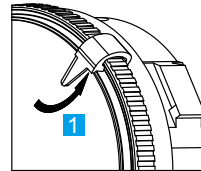

- 1 Remove the limit hand by lifting it in the direction indicated by the arrow.

4. Measurement Method

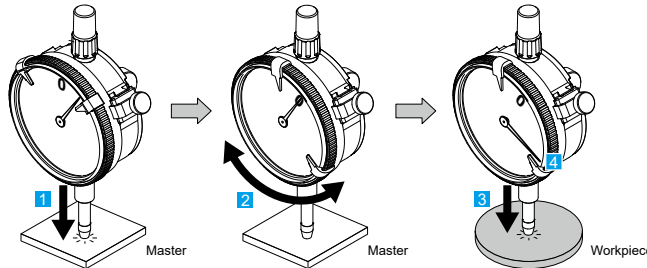

- 1 Set the pointer position to the reference point with a reference gage or master. Read the short pointer (revolution counting device) value as well if available.
- 2 Turn the bezel to adjust the zero point as required.
- 3 Measure the workpiece in the same orientation and conditions as the reference point setting.
- 4 Read the pointer value from the front. Read the short pointer (revolution counting device) value as well if available.

NOTICE Shows risks that could result in property damage.

If the contact point strikes the workpiece to be measured hard, the workpiece may deform and measurement results may be affected.

5. Cleaning after Use

- Clean the sliding surface of the plunger with a dry cloth or a cloth slightly moistened with alcohol. Do not lubricate the plunger at this time.
- Clean the crystal with a soft, dry cloth or a cloth slightly moistened with neutral detergent. Do not use anything but neutral detergent.
- The performance of the dial indicator is strongly influenced by usage and storage conditions. We recommend stipulating a maintenance cycle in-house according to usage frequency, environment, storage method, etc., and inspecting the product periodically.
- If the product is repaired or disassembled by a party other than Mitutoyo, its performance cannot be guaranteed.

6. Specifications

- Operation environment: Temperature 0°C to 40°C, humidity 30% to 70% (no condensation)

7. Accessories (Optional)

- Bezel clamp (standard accessory except for metric type)
- Limit hand
- Replacement contact points
- Extension rod
- Backs
- Lifting lever
- Lifting cable
- Arm

*Refer to the Measuring Instruments Catalog for target models and part numbers.

8. Off-Site Repairs (Subject to Charge)

Off-site repair (subject to charge) is required in the case of the following malfunctions. Contact your nearest dealer or our sales office.

- Poor plunger operation
- Serious pointer dwell position deviation (pointer skipping)
- Poor accuracy