

# Depth Gage (Digital Type ID-CNX)



## Safety Precautions

To ensure operator safety, use this product in conformance with the directions, functions and specifications given in this User's Manual. Use under other conditions may compromise safety.

**WARNING** Shows risks that could result in death or serious injury.

- Always keep batteries out of reach of children. If swallowed, consult a physician immediately.
- Batteries should never be short-circuited, disassembled, deformed or come in contact with extreme heat or flames.
- If battery alkaline liquid comes in contact with the eyes, flush eyes immediately with clean water and consult a physician. If battery alkaline liquid comes in contact with the skin, flush the exposed area thoroughly with clean water.

**CAUTION** Shows risks that could result in minor or moderate injury.

Never attempt to charge the primary battery. Never reverse the positive-negative terminals when mounting. Improper battery handling or mounting may cause battery leakage and explosion, which may cause product malfunctions and serious bodily injury.

**NOTICE** Shows risks that could result in property damage.

- Do not disassemble or modify.
- Do not use or store the product in a place with sudden temperature changes. Adapt the product to room temperature before use.
- Use in a location with minimal dust, oil, and oil mist, away from direct sunlight.
- Do not store the product in a place with high humidity or a lot of dust.
- Do not move the plunger quickly or apply horizontal force.
- Avoid loads in the vertical direction relative to the plunger or usage involving torsion to the plunger.
- Do not apply excessive force or subject to sudden impacts such as when dropped. If an impact is applied, inspect accuracy and operation before use.
- Avoid usage in places directly exposed to splashes of water or coolant.
- Do not write numbers, etc. with an electric pen.
- Do not operate the keys with a pointed object (such as a screwdriver or ballpoint pen).

## Contents

1. Types .....	Page 1
2. Names of Components .....	Page 1
3. Preparations before Use .....	Page 2
4. Installing (Replacing) the Battery .....	Page 2
5. Power ON/OFF .....	Page 3
6. Operation Modes .....	Page 3
7. Switching Measurement Systems .....	Page 3
8. Switching Unit System .....	Page 3
9. Measurement Method .....	Page 3
10. Externally Outputting the Displayed Value .....	Page 5
11. Setting Parameters .....	Page 6
12. Lifting Lever .....	Page 11
13. Precautions after Use .....	Page 11
14. Error Displays and Countermeasures .....	Page 11
15. Input/Output Functions .....	Page 12
16. Specifications .....	Page 13
17. Accessories (Optional) .....	Page 13
18. Off-Site Repairs (Subject to Charge) .....	Page 13

## Key Notations

In this manual, the names of the keys to be pressed, their operations (length and number of times the key is pressed), and the progress directions of procedures are indicated by arrows. E.g.: [F2] key

	Press the [F2] key and release it immediately (short press).
	Press the [F2] key and release it after 2 seconds or longer (long press).

## 1. Types

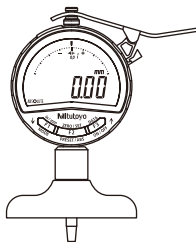

- Code No.  
547-211A  
547-217A  
547-251A  
547-257A

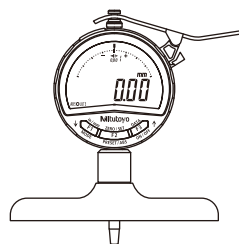

- Code No.  
547-212A  
547-218A  
547-252A  
547-258A

## 2. Names of Components

The figure shows 547-217A.

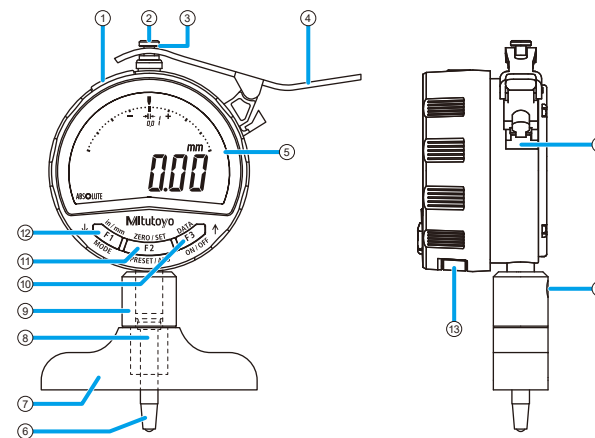

- ① I/O connector (with cover)
- ② Stop screw
- ③ Spacer
- ④ Lifting lever
- ⑤ Display (LCD)
- ⑥ Contact point
- ⑦ Base
- ⑧ Plunger
- ⑨ Holder
- ⑩ [F3] key
- ⑪ [F2] key
- ⑫ [F1] key
- ⑬ Battery holder
- ⑭ Dovetail
- ⑮ Set screw

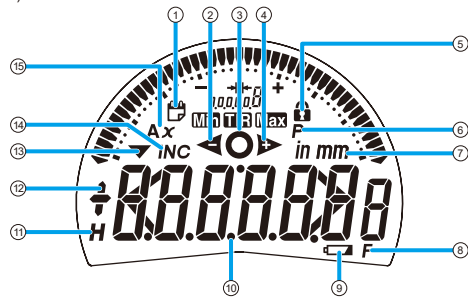

- ① Calibration schedule warning display
- ② Tolerance judgment result display (-NG)
- ③ Tolerance judgment result display (OK)
- ④ Tolerance judgment result display (+NG)
- ⑤ Function lock display
- ⑥ Preset display
- ⑦ Unit display
- ⑧ Key customization display
- ⑨ Battery voltage decrease display
- ⑩ Measurement value display (tolerance judgment enlarged display)
- ⑪ Hold display
- ⑫ Sign display
- ⑬ Reverse counting display
- ⑭ INC display
- ⑮ Calculation function display (not used with this product)
- ⑯ Analog bar display
- ⑰ Analog bar scale display
- ⑱ Minimum value detection display
- ⑲ Runout width detection display
- ⑳ Maximum value detection display

### 3. Preparations before Use

#### 1) Checking items before use

- Before using the product, confirm that the plunger moves smoothly.
- Confirm that the displayed value is stable at the position you have set. Body temperature or changes in air temperature may cause thermal expansion or contraction of parts such as the plunger, changing the displayed values.
- For precision measurement, wear thick gloves in order to reduce changes in the displayed value caused by the transmission of body temperature.

#### 2) Mounting the extension rod (standard accessory)

Use this if the measurement location is deep enough that the contact point cannot reach it. Multiple extension rods may be combined depending on the measurement being made.

**NOTICE** Shows risks that could result in property damage.

- If the total length of multiple extension rods is 110 mm or more, make sure to use in the vertical orientation (contact point facing down). Plunger operation may be affected.
- When removing or mounting a contact point or extension rod, apply a soft cloth such as felt to the knurled part (if not knurled, to the area near the plunger), and then use pliers or longnose pliers.

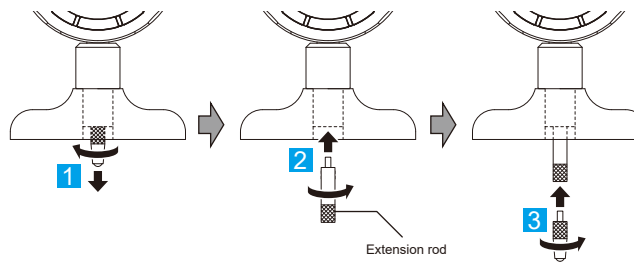

- 1 Remove the contact point.
- 2 Mount the extension rod to the main body.
- 3 Mount the contact point to the top of the extension rod.

### 4. Installing (Replacing) the Battery

**CAUTION** Shows risks that could result in minor or moderate injury.

- Be sure to use CR2032 (lithium metal battery) for the battery. The use of a different battery type may lead to explosions.
- Please note that you may damage your nails when removing the battery holder.

**NOTICE** Shows risks that could result in property damage.

- Do not use a pointed object or excessive force to remove the battery holder. This may damage the battery holder.
- The product may be damaged or break down if the battery and battery holder are not mounted correctly.
- If the product will be out of use for 3 months or more, the device may be damaged due to battery leakage. Remove the battery and store it separately.

**This product is shipped without a battery installed. Install the battery provided before use.**

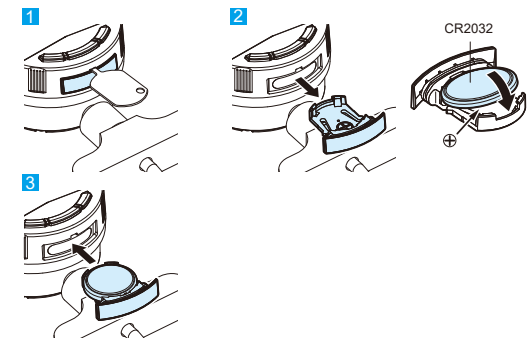

- 1 Remove the battery holder using a battery holder opener (standard accessory) or a flathead screwdriver.

#### Tips

If replacing a battery, remove the existing battery from the battery holder.

- 2 Insert the battery into the battery holder with the "+" symbol facing down.
- 3 Reattach the battery holder.

**When the calibration schedule warning function is OFF:**

⇒ The power turns ON and [-----] is displayed.



**When the calibration schedule warning function is ON:**

⇒ The power turns ON and [today] is displayed.



#### Tips

- If no value is displayed even when the above operation is performed, reinstall the battery.
- The battery provided is for confirming the functions and performance of the product. Note that this battery may not last for the entire expected life.

#### 4. Press the [F2] key.

When the calibration schedule warning function is OFF:

⇒ The mode switches to measurement mode (current position display).

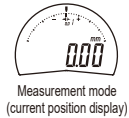

When the calibration schedule warning function is ON:

⇒ The current date is displayed.

Press the [F2] key to confirm the current date (example: August 25, 2020).



#### Tips

- To change the date, refer to step 3 in "11-1) Selecting/setting calibration schedule warnings".
- Refer to "11-1) Selecting/setting calibration schedule warnings" for details on turning the calibration schedule warning ON/OFF or setting the calibration time.
- When the battery is replaced, the measurement mode will use the same display method and measurement system used prior to removing the battery.  
Examples: Peak detection, absolute measurement (ABS)
- Dispose of batteries in accordance with the law and any other regulations.

#### 5. Power ON/OFF

##### ● Turning the power ON

Press the [F3] key.  
⇒ The product starts up in measurement mode.

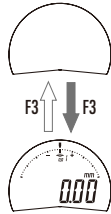

#### Tips

The measurement system when the power is turned ON is the same as it was when turned OFF. Refer to "7. Switching Measurement Systems" for details.

##### ● Turning the power OFF

Press and hold the [F3] key.  
⇒ The LCD turns off.

#### Tips

Turning the power OFF while making settings will cancel the setting and return the product to the status before setting.

#### Key icon operation

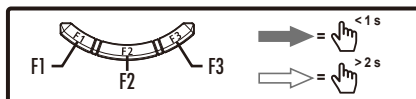

#### 6. Operation Modes

This product is equipped with the following two operation modes.

##### • Measurement mode:

This mode is used for tasks such as normal measurement, calculation measurement (not used by this product), tolerance judgment, holding displayed values, and outputting displayed values to an external device.

When in measurement mode, three methods for displaying measurement values are available for selection.

	Standard 1	Standard 2	Peak detection <sup>1</sup>
Measured value display	Directly displays the measured value to be displaced.		Holds and displays the peak value of the measured value to be displaced.
Display of analog bar	Yes	No	Yes
Key customization <sup>2</sup>	Customizable	Not customizable	Not customizable

\* 1 Refer to "9. Measurement Method" - "3) Detecting peaks" for details on peak detection.

\* 2 Refer to "9. Measurement Method" - "6) Customizing keys" for details on customization.

##### • Parameter setting mode:

This mode is used to set parameters.

Refer to "11. Setting Parameters" for details on how to set parameters.

#### 7. Switching Measurement Systems

This product is equipped with the following two measurement systems.

##### • Absolute measurement (ABS):

Sets (presets) the measurement origin and measures the dimensions of the workpiece. The origin can be set to any desired value to support a wide range of workpieces.

##### • Incremental measurement (INC):

Sets a reference point on the master for use as a reference (zeros the displayed value) and measures the difference between the master and a workpiece.

##### ● Switching to absolute measurement (ABS)

Press and hold the [F2] key.

##### ● Switching to incremental measurement (INC)

Press the [F2] key.

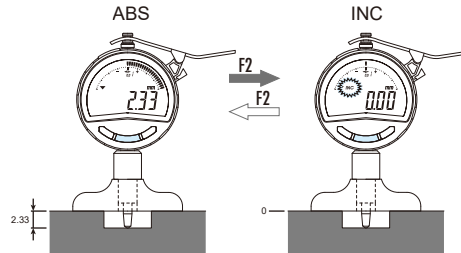

#### Tips

The displayed value is simultaneously reset to zero when switching from absolute measurement (ABS) to incremental measurement (INC).

#### 8. Switching Unit System

The unit display can be switched between mm and in.

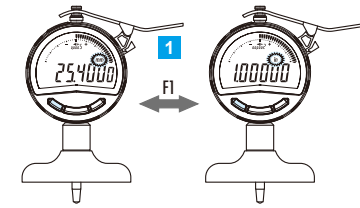

##### 1) Press the [F1] key.

⇒ Each time the key is pressed, the unit display switches.

#### Tips

• This function is available only when the following measurement mode and switch function selection are set.

Measurement mode	Switch function selection
Standard 1	Default
Standard 1	[F1] key = [unit]
Standard 2	-

When peak detection is selected in measurement mode selection, this function cannot be used. Change units with unit system selection in the parameter setting mode.

For details about measurement mode selection, switch function selection and unit system selection, refer to "11. Setting Parameters".

- When the unit is switched, the following will be converted accordingly: display value, preset values, tolerance value, resolution, and analog bar graduation.
- If it causes a display value overflow error (Err 30), set the proper resolution. For details, refer to "14. Error Displays and Countermeasures".
- Additionally, if there is an overflow or conversion error after switching units, checking the values of each setting is recommended.

#### 9. Measurement Method

Be sure to set the measurement origin (ABS) or reference point (INC) before measurement. For use in a place with fluctuating temperature in particular, frequently check the set origin/reference point. Use a cloth dipped in a small amount of alcohol to wipe away any dust or cutting chips from the contact point and bottom of the base prior to measurement.

**NOTICE** Shows risks that could result in property damage.

- Do not allow the contact point to strike the workpiece hard. The workpiece may deform and measurement results may be affected.
- When measuring, do not loosen the screw, or remove and disassemble it.

#### Tips

If an extension rod was mounted, use a reference gauge or master to align the reference point.

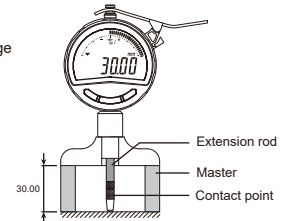

## 1) For incremental measurement (INC)

Zeros the dimensions of the master to use as reference and measures the dimensional difference with the workpiece.

1 Confirm that the product is in incremental measurement (INC display is turned on), and check the counting direction.

### Tips

- If set to absolute measurement, switch the measurement system to incremental measurement. Refer to "7. Switching Measurement Systems" for details.
- Negative counting is normally used. Refer to "11. Setting Parameters" - "4) Selecting the counting direction" for details.

2 Press the base surface against the reference plane (a scale or other surface guaranteed to be flat) and slide it horizontally several times.

3 Press the [F2] key.

⇒ The displayed value is set to zero.

4 Repeat step 2 several times to confirm that the reference point is not misaligned.

5 Replace the master with the workpiece and perform incremental measurement.

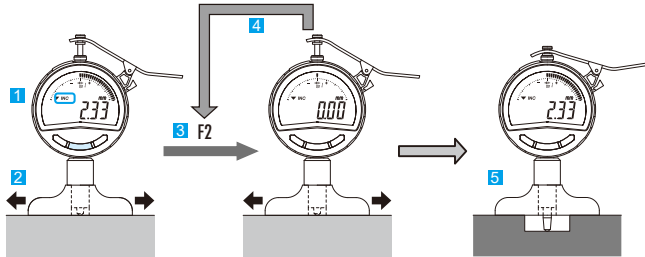

## 2) For absolute measurement (ABS)

Sets (presets) the measurement origin and measures the dimensions of the workpiece.

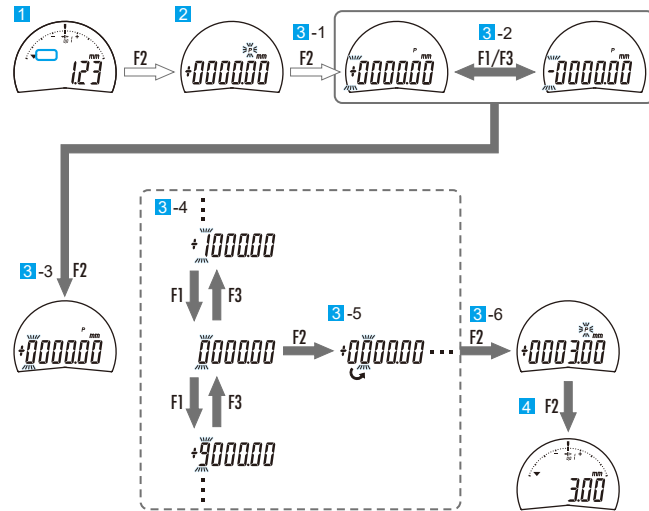

1 Confirm that the product is in absolute measurement (INC display is turned off), and check the counting direction.

### Key icon operation

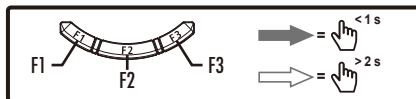

### Tips

- If set to incremental measurement, switch the measurement system to absolute measurement. Refer to "7. Switching Measurement Systems" for details.
- Negative counting is normally used. Refer to "11. Setting Parameters" - "4) Selecting the counting direction" for details.

2 Press and hold the [F2] key to start setting (presetting) the measurement origin.

⇒ Preset display ([P]) will blink and the previous preset value will be displayed.

3 Set the preset value.

1 Press and hold the [F2] key.

⇒ The sign will blink and the preset value can be changed.

2 Press the [F1] key or [F3] key.

⇒ Each time the key is pressed, it will switch the sign.

3 Press the [F2] key.

⇒ The sign is confirmed and the neighboring digit blinks.

4 Press the [F1] key or [F3] key.

⇒ Each time the key is pressed, the value will change by one.

5 Press the [F2] key.

⇒ The number is confirmed and the neighboring digit blinks.

⇒ Each time the key is pressed, the blinking digit moves to the right.

6 Repeat steps 4 to 5 above until the numbers for all digits are confirmed.

⇒ Confirming the last digit will cause preset display ([P]) to blink.

4 Press the [F2] key to exit the origin setting (presetting).

⇒ The preset display turns off and the setting is concluded.

### Tips

- Press and hold the [F1] key to cancel the preset setting.
- If the preset value is incorrect, press and hold the [F2] key and redo from step 3.

5 Press the base surface against the master and slide it horizontally several times.

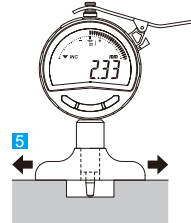

6 Set the origin.

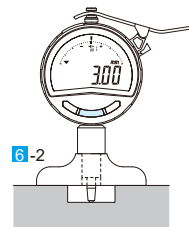
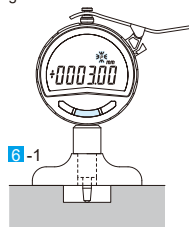

1 Press and hold the [F2] key.

⇒ Preset display ([P]) will blink and the previous preset value (example: 3.00 mm) will be displayed.

2 Confirm the preset value, and then press the [F2] key.

⇒ The measurement origin is set as the preset value and it becomes measurable.

7 Replace the master with the workpiece and perform absolute measurement.

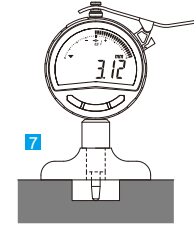

### Tips

- The set preset value and origin are retained even when the power is turned off. However, the preset value is cleared when All Reset is performed and must be reset.
- The preset value is automatically converted when the unit system or resolution is changed. In this case, however, a conversion error may be produced. It is therefore recommended to check the preset value after changing the unit system or resolution.

## 3) Detecting peaks

During peak detection, measurement is performed by moving and rotating the workpiece while it is gripped. The displayed value can be switched between the runout width (TIR), the maximum value (Max), and the minimum value (Min) detected as the displacement peak value.

### ● Current value display

Current measurement value is always displayed.

### ● Runout width (TIR) display

The runout width (maximum value - minimum value) is always displayed relative to the displacement of the measured value. [Max] or [Min] blinks when the maximum and minimum values are updated. Tolerance judgment results are displayed with respect to the runout.

### Tips

- When [Auto] is selected in "Analog bar display selection" in the parameter setting mode, the analog bar scale automatically changes so that the pointer of the analog bar is always within the display range with respect to the displacement of the measured value.
- For tolerance judgment, the set upper/lower limit width is compared with the measured runout width.

### ● Maximum value (Max) display

The maximum value is always displayed relative to the displacement of the measured value. [Max] blinks when the maximum values are updated. Tolerance judgment results are displayed with respect to the maximum value.

### Tips

- In absolute measurement, it is possible to preset any maximum value and perform measurement based on that position. Refer to "9. Measurement Method" - "2) For absolute measurement (ABS)" for preset settings.
- If the pointer on the analog bar exceeds the display range with respect to the displacement of the measured value, the pointer automatically returns to the center position.

### ● Minimum value (Min) display

The minimum value is always displayed relative to the displacement of the measured value. [Min] blinks when the minimum values are updated. Tolerance judgment results are displayed with respect to the minimum value.

### Tips

- In absolute measurement, it is possible to preset any minimum value and perform measurement based on that position. Refer to "9. Measurement Method" - "2) For absolute measurement (ABS)" for preset settings.
- If the pointer on the analog bar exceeds the display range with respect to the displacement of the measured value, the pointer automatically returns to the center position.

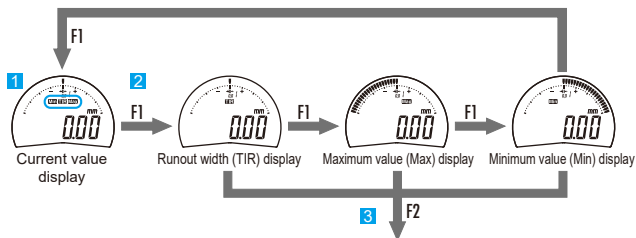

1 Make sure that the measurement mode is set to peak detection (peak detection display is turned on).

#### Tips

- Refer to "11. Setting Parameters" - "2) Selecting the measurement mode" for details on switching the display in the measurement mode.
- Peak detection begins once the display method in measurement mode switches to peak detection.

- 2 Press the [F1] key to switch to peak detection display.  
 ⇨ Each time the key is pressed, it will switch the peak detection display.
- 3 Press the [F2] key to reset the peak value and begin measuring.  
 ⇨ The selected peak detection display value is displayed.

**For peak detection, start measurement with the workpiece gripped.**

#### Tips

- Be careful during measurement as displacement due to vibration or impact is also detected.
- Peak detection will continue until the [F2] key is pressed again. To start a new peak detection, press the [F2] key to reset the peak value.
- The displayed values can be held during peak detection. Refer to "9. Measurement Method" - "5) Holding the displayed value" for details.
- By switching the measurement mode to peak detection while holding, the amplitude, maximum value and minimum value that are being held can be checked. While the display value is being held, it will not switch to the current value display.

#### 4) Judging tolerance

The upper/lower limit allowable values can be set to provide a GO/NG judgment for the measured value (pass/fail judgment).

Allowable values can be set independently for absolute measurement (ABS)/incremental measurement (INC).

Refer to "11. Setting Parameters" - "6) Selecting the tolerance judgment result display method and setting allowable values" for settings.

#### ● Displaying tolerance judgment results

Normal display  
(measured value and judgment result)



Enlarged display  
(judgment result only)



#### 5) Holding the displayed value

If an external device is not connected, the displayed value can be held (fixed).

#### Tips

During tolerance judgment enlarged display, the Hold function will not work. Refer to "9. Measurement Method" - "4) Judging tolerance" for details on the tolerance judgment enlarged display.

- 1 Press the [F3] key.  
 ⇨ Hold display ([H]) will appear and the displayed value will be held (the displayed value will be retained even if the workpiece is removed).
- 2 Press the [F3] key while the displayed value is held.  
 ⇨ Hold display ([H]) turns off and the held displayed value is released.

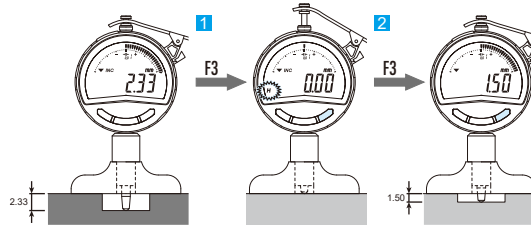

#### 6) Customizing keys

Depending on how this product is used, it is possible to customize the functions assigned to short-pressing of each key ([F1] key, [F2] key, [F3] key).

Each key can be customized using "Switch function selection" in the parameter setting mode. Refer to "11. Setting Parameters" - "9) Selecting switch functions" for details.

Example 1:

[F1] key	[F2] key	[F3] key
[dir]	[P.CALL]	[hoLd]
Counting direction switching	Preset recall	Display value hold

Example 2:

[F1] key	[F2] key	[F3] key
[nonE]	[ZEro]	[nonE]
No function	Zero setting	No function

#### Tips

- Key customization is available only when the measurement mode is in "Standard 1".
- After performing key customization, change the switch selection function to "default ([dEF])" when reverting to the default function assignment. Refer to "11. Setting Parameters" - "9) Selecting switch functions" for details.

#### 10. Externally Outputting the Displayed Value

Display values can be output to various external devices (external display, external printer, PC, etc.) by connecting a connection cable to this product.

#### Tips

- Refer to "17. Accessories (Optional)" for connection cables (optional) that can be connected to this product.
- Refer to "15. Input/Output Functions" for details on connection cable pin assignments, the output data format, and the timing chart.
- Carefully read the User's Manual of the data processing device to be connected when using the External Output function.

#### 1) Connecting to an external device

**NOTICE** Shows risks that could result in property damage.

Do not pull the connection cable with force. This may cause damage.

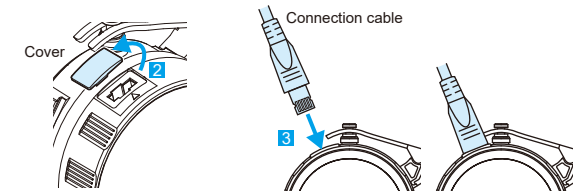

- 1 Press and hold the [F3] key.  
 ⇨ Power turns off.
- 2 Remove the cover of the I/O connector of this product.
- Store the removed cover to prevent loss.
  - Always install the cover if a connection cable is not used.
- 3 Connect the connection cable to this product.  
**When inserting a connection cable, pay attention to the connector direction (align the ▲ marks).**
- 4 Connect the other end to the external device.  
**When removing the connection cable, hold the connector on the tip.**

#### Key icon operation

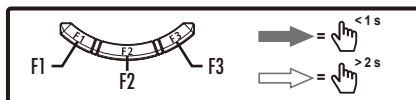

## 2) Operating external output

The displayed value is output to the connected external device.  
This operation is enabled only when this product is connected to an external device.

### 1 Press the [F3] key while in measurement mode.

⇒ The displayed value is output to the connected external device.

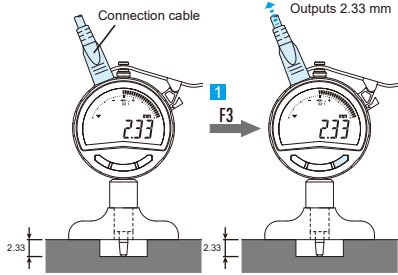

### Tips

- Refer to "15. Input/Output Functions" for details on connection cable pin assignments, the output data formats, and the timing chart.
- If inputting an output request (REQ) from the connected external device, do so only when the plunger is stopped. If an output request (REQ) is input while the plunger is moving, it may output an incorrect value or data output may not be possible.
- If output requests (REQ) are input over short intervals, data output may not be possible.
- External output using the [F3] key is not possible during tolerance judgment enlarged display. The measured value is externally output only when an output request (REQ) from an external device is received.

## 11. Setting Parameters

The parameter setting mode includes the following parameter items.

Display	Setting details	Default setting
ModE	Measurement mode selection	Standard 1
unit	Unit system selection (Code No. 547-217A, 547-257A, 547-218A, 547-258A)	in
dir.	Counting direction selection	Positive direction
rES.	Resolution selection (Code No. 547-251A, 547-252A, 547-257A, 547-258A)	0.0005 mm 0.00002 in
toL.	Tolerance judgment result display selection and allowable value setting	Display OFF
CALC.*	Calculation function selection and calculation coefficient setting	Calculation OFF
A-bAr	Analog bar display selection	Display ON
S-SEL	Switch function selection	Default
F-Loc	Function lock setting	Lock OFF
othEr	Change other functions	-
CAL.ALt	Calibration schedule warning selection/setting	Warning OFF
outPut	Digimatic output selection (Code No. 547-251A, 547-252A, 547-257A, 547-258A)	DIGIMATIC d2
Auto.oF	Auto OFF setting	OFF
rESEt	All reset	-

\*This function affects accuracy, and is therefore not used with this product.

## 1) Display order of parameter items

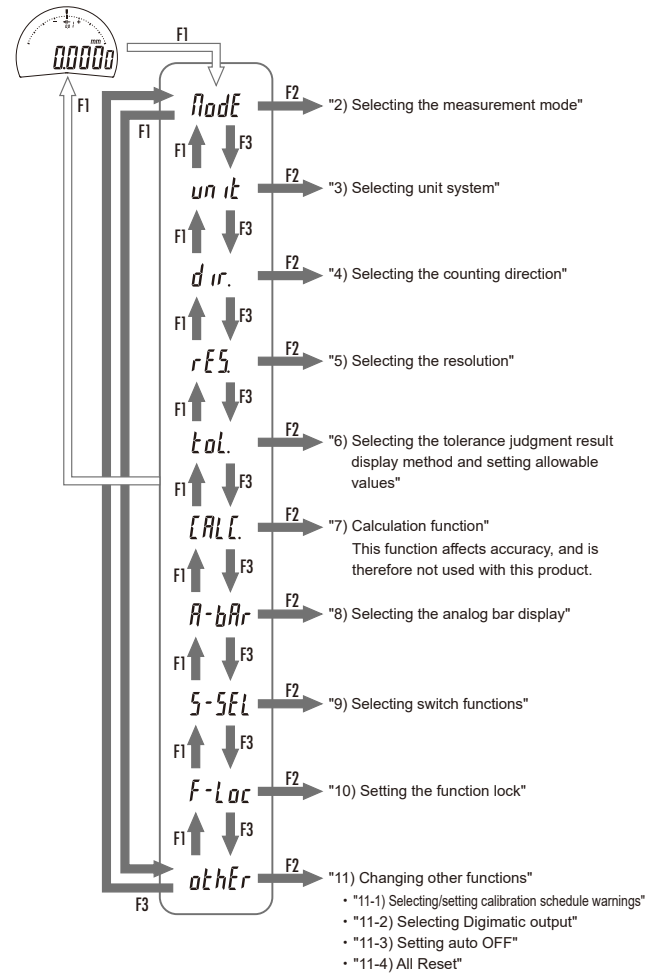

### Tips

- Press and hold the [F1] key to cancel the parameter setting. Note that unconfirmed settings will not be reflected.
- Parameter settings are retained even when the power is turned OFF. However, when All Reset is performed, the settings will be reset to the factory defaults.

## 2) Selecting the measurement mode

The measurement mode can be selected from "Standard 1", "Standard 2" and "Peak Detection".

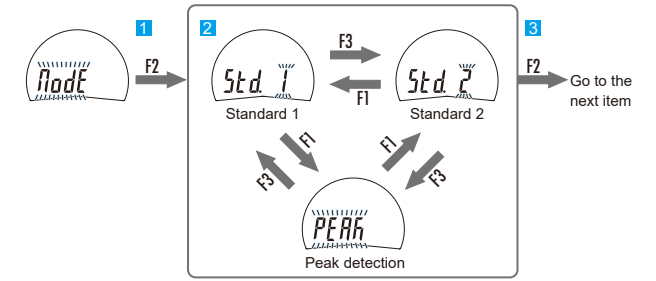

### 1 Press the [F2] key.

⇒ Measurement mode can be set.

### 2 Press the [F1] key or [F3] key to set the measurement mode.

⇒ Each time the key is pressed, it will switch the measurement mode in order.

### 3 Press the [F2] key.

⇒ Settings are confirmed; shifts to the next parameter item.  
(Go to "3) Selecting unit system".)

### Tips

Standard 1, 2 and peak detection have different function assignments when respective key ([F1] key, [F2] key, [F3] key) is short pressed.

Measurement mode	[F1] key	[F2] key	[F3] key
Standard 1	Customizable (Initial settings: "N/A", "Zero setting", "Data hold")		
Standard 2	Unit switching	Zero setting	Data hold
Peak detection	Peak detection display switching	Peak detection start	Data hold

## 3) Selecting unit system

The unit system (in ↔ mm) can be set (Code No. 547-217A, 547-218A, 547-257A, 547-258A).

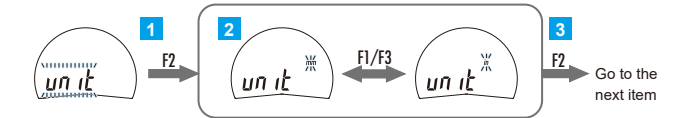

### 1 Press the [F2] key.

⇒ Unit system can be set.

### 2 Press the [F1] key or [F3] key to set the unit system.

⇒ Each time the key is pressed, it will switch between [in] and [mm].

### 3 Press the [F2] key.

⇒ Settings are confirmed; shifts to the next parameter item.  
(Go to "4) Selecting the counting direction".)

## Key icon operation

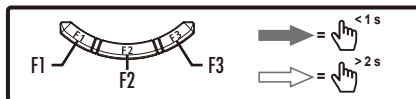

#### 4) Selecting the counting direction

The counting direction can be selected with regard to the plunger movement direction. Negative counting is normally used.

##### ■ Positive counting



##### ■ Negative counting

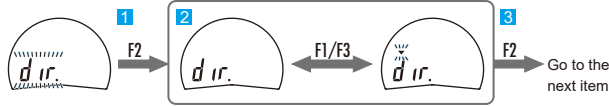

- 1 Press the [F2] key.  
⇒ The counting direction can be selected.
- 2 Press the [F1] key or [F3] key to select the counting direction.  
[▼] OFF: Counts up (positive counting) when the plunger is raised.  
[▼] Blinking: Counts down (negative counting) when the plunger is raised.  
⇒ Each time the key is pressed, it will switch the counting direction.
- 3 Press the [F2] key.  
⇒ Settings are confirmed; shifts to the next parameter item.  
(Go to "5) Selecting the resolution".)

#### 5) Selecting the resolution

For Code No. 547-251A, 547-252A, 547-257A and 547-258A, the resolution can be selected.

When the unit system is mm (Code No. 547-251A, 547-252A)

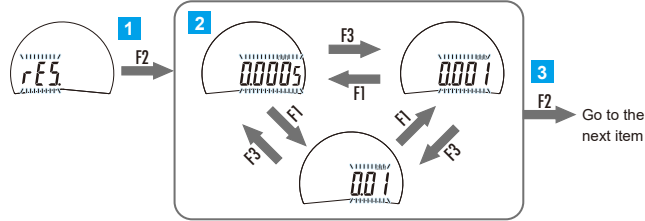

#### Key icon operation

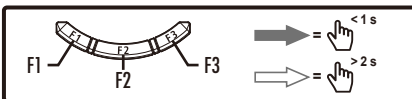

When the unit system is inch (Code No. 547-257A, 547-258A)

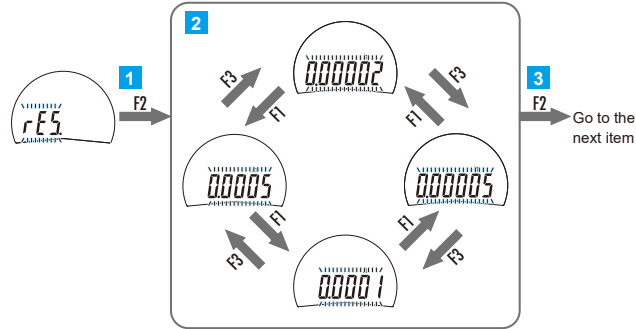

- 1 Press the [F2] key.  
⇒ Resolution can be set.  
⇒ Each time the key is pressed, it will switch the resolution.
- 2 Press the [F1] key or [F3] key to set the resolution.  
⇒ Each time the key is pressed, it will switch the resolution.
- 3 Press the [F2] key.  
⇒ Settings are confirmed; shifts to the next parameter item.  
(Go to "6) Selecting the tolerance judgment result display method and setting allowable values".)

#### 6) Selecting the tolerance judgment result display method and setting allowable values

The display method during tolerance judgment can be selected, and the allowable values (upper limit value and lower limit value) can be set. Allowable values can be set independently for each measurement system (absolute measurement (ABS) and incremental measurement (INC)).

##### Tips

Refer to "7. Switching Measurement Systems" for details on switching between absolute measurement (ABS) and incremental measurement (INC).

#### 6-1) Setting the display method

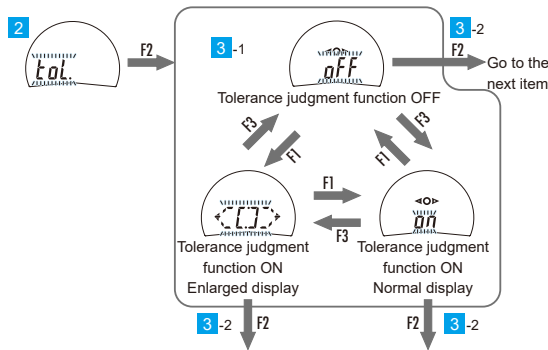

Setting allowable values (upper limit value and lower limit value)

- 1 Confirm that the measurement system for which to use the tolerance judgment function is selected.
- 2 Press the [F2] key.  
⇒ Tolerance judgment function can be set.

##### Tips

Refer to "7. Switching Measurement Systems" for details on switching between absolute measurement (ABS) and incremental measurement (INC).

#### 3) Set the measurement result display method.

- 1 Press the [F1] key or [F3] key.  
⇒ Each time the key is pressed, it will switch the display method.
- 2 Press the [F2] key.

When "Tolerance judgment function ON (normal display or enlarged display)" is selected:

- ⇒ [▶] will blink and the previously set upper limit value will be displayed.  
To skip the upper limit setting, press the [F2] key again.  
(Go to step 2 in "6-2) Setting allowable values (upper limit value and lower limit value)".)

When "Tolerance judgment function OFF" is selected:

- ⇒ Settings are confirmed; shifts to the next parameter item.  
(Go to "7) Calculation function".)

##### Tips

When "peak detection" is selected in measurement mode selection, "enlarged display" cannot be selected.

#### 6-2) Setting allowable values (upper limit value and lower limit value)

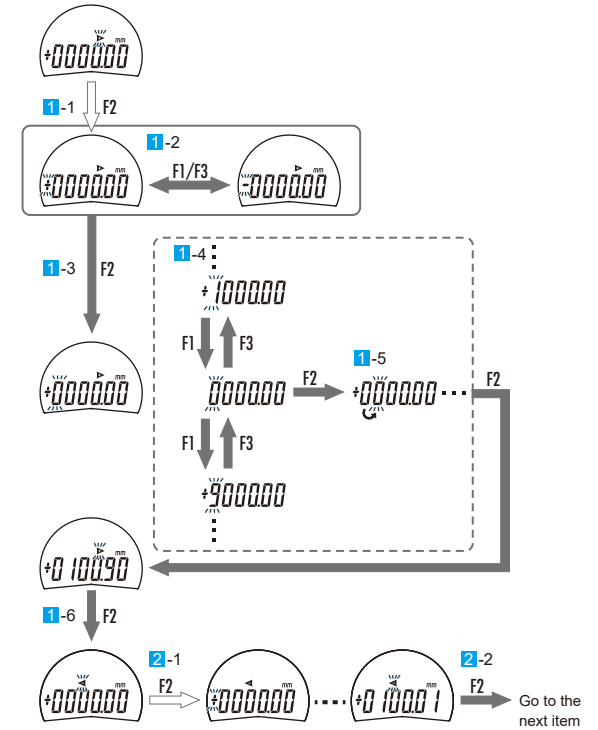

- 1 Set the upper limit.
  - 1 Press and hold the [F2] key.  
⇒ The sign will blink and can be changed.  
⇒ Go to 3 if not changing the sign.
  - 2 Press the [F1] key or [F3] key.  
⇒ Each time the key is pressed, it will switch the sign.
  - 3 Press the [F2] key.  
⇒ The sign is confirmed and the neighboring digit blinks.
  - 4 Press the [F1] key or [F3] key.  
⇒ Each time the key is pressed, the value will change by one.
  - 5 Press the [F2] key.  
⇒ The number is confirmed and the neighboring digit blinks.  
⇒ Each time the key is pressed, the blinking digit moves to the right.  
Repeat steps 4 to 5 above until the numbers for all digits are confirmed.  
⇒ Confirming the last digit will cause [▶] to blink.

- 6 Press the [F2] key.
  - ⇒ The upper limit setting is confirmed.
  - ⇒ [◀] will blink and the previously set upper limit value will be displayed.
- 2 Set the lower limit.
  - 1 Set in the same way as the upper limit (step 1).
  - 2 Press the [F2] key.
    - ⇒ Settings are confirmed; shifts to the next parameter item. (Go to "7) Calculation function".)

#### Tips

- Press and hold the [F1] key to stop or cancel settings midway through.
- If the upper limit is set below the lower limit, the error display [Err 90] appears and the set value will not be reflected. Clear the error display by pressing the [F2] key and, starting with the upper limit, reset so that the upper limit is above the lower limit. ("14. Error Displays and Countermeasures".)
- Allowable values cannot be set for "normal display" and "enlarged display" separately.
- Allowable values are automatically converted when the resolution is changed. In this case, however, a conversion error may be produced. It is therefore recommended to check the allowable values after changing the resolution.

### 7) Calculation function

This function affects accuracy, and is therefore not used with this product. Operate as follows.



- 1 Press the [F2] key twice.
  - ⇒ Shifts to the next parameter item (go to "8) Selecting the analog bar display").

### 8) Selecting the analog bar display

The analog bar display can be turned ON/OFF. In addition, settings of the displayed analog bar scale ( $\pm 20$ ) can be changed.

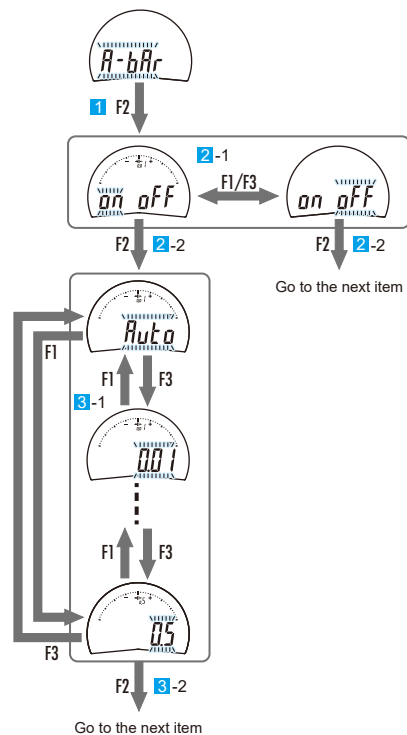

- 1 Press the [F2] key.
  - ⇒ Analog bar display can be set.
- 2 Select ON/OFF for the analog bar display.
  - 1 Press the [F1] key or [F3] key.
    - ⇒ Each time the key is pressed, the analog bar display turns ON/OFF alternately.
  - 2 Press the [F2] key.
    - If analog bar display ON [on] is selected:**
      - ⇒ Analog bar scale can be set.
    - When analog bar display OFF [oFF] is selected:**
      - ⇒ Selection is confirmed; shifts to the next parameter item. (Go to "9) Selecting switch functions".)

### 3) Setting the analog bar scale

- 1 Press the [F1] key or [F3] key.
  - ⇒ Each time the key is pressed, the setting of the analog bar scale changes.

Code No. 547-251A, 547-252A	
mm	in
Auto	Auto
0.0005	0.0005
0.001	0.001
0.002	0.002
0.005	0.005
0.01	0.01
0.02	0.02
0.05	0.05
0.1	0.1
0.2	0.2
0.5	0.5

Code No. 547-211A, 542-212A	
mm	in
Auto	Auto
0.01	0.01
0.02	0.02
0.05	0.05
0.1	0.1
0.2	0.2
0.5	0.5

Code No. 547-257A, 547-258A	
mm	in
Auto	Auto
0.0005	0.0002
0.001	0.0005
0.002	0.001
0.005	0.002
0.01	0.005
0.02	0.01
0.05	0.02
0.1	0.05
0.2	0.1
0.5	0.2

Code No. 547-217A, 547-218A	
mm	in
Auto	Auto
0.01	0.0005
0.02	0.001
0.05	0.002
0.1	0.005
0.2	0.01
0.5	0.02

- 2 Press the [F2] key.
  - ⇒ Settings of analog bar scale are confirmed; shifts to the next parameter item. (Go to "9) Selecting switch functions".)

#### Tips

- When [Auto] is selected for the analog bar scale, it automatically switches to the analog bar scale when the conditions below are present.
- When peak detection runout width (TIR) displayed: The runout width is the analog bar display entered within the analog bar display range
  - When tolerance judgment function ON: The preset value is the analog bar display entered in the analog bar display range
  - When resolution switched: Analog bar display that is identical to resolution

### 9) Selecting switch functions

The function assignments when respective key ([F1] key, [F2] key, [F3] key) is short pressed (switch function).

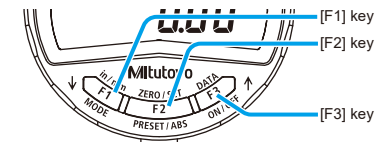

#### Key icon operation

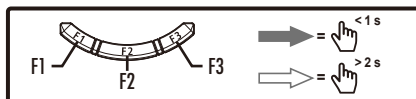



### Tips

Changes can be made regardless of the measurement mode, but the changed function will be enabled only when the measurement mode is "Standard 1".

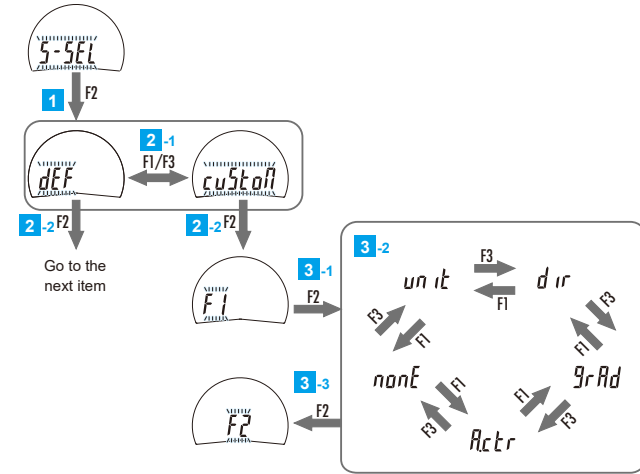

- 1 Press the [F2] key.  
⇒ Switch function can be set.
- 2 Select the default/customized switch function.
  - 1 Press the [F1] key or [F3] key.  
⇒ Each time the key is pressed, the default/customized switch function alternates.
  - 2 Press the [F2] key.

#### When customize [cuStoM] is selected:

⇒ The function assignment of the [F1] key becomes settable, and [F1] blinks.

#### If default [dEF] is selected:

⇒ Selection is confirmed; shifts to the next parameter item.  
(Go to "10) Setting the function lock".)

- 3 Setting the function assigned to the [F1] key
  - 1 Press the [F2] key.  
⇒ The function assigned to the [F1] key can be set.
  - 2 Press the [F1] key or [F3] key.  
⇒ Each time the key is pressed, it will switch the functions in order.
  - 3 Press the [F2] key.  
⇒ The function assignment of the [F1] key is confirmed and [F2] blinks.
- 4 Setting the function assigned to the [F2] key

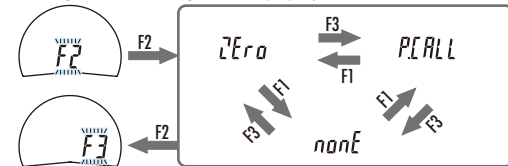

- 1 Set in the same manner as the [F1] key (step 3).
- 2 Press the [F2] key.  
⇒ The function assignment of the [F2] key is confirmed and [F3] blinks.

### Key icon operation

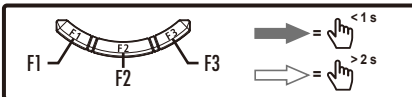

### 5) Setting the function assigned to the [F3] key

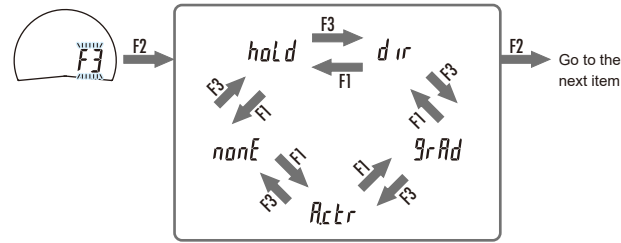

- 1 Set in the same manner as the [F1] key (step 3).
- 2 Press the [F2] key.  
⇒ The function assignment of the [F3] key is confirmed; shifts to the next parameter item.  
(Go to "10) Setting the function lock".)

### Functions that can be assigned to each key

[F1] key	[F2] key	[F3] key
[nonE]	[nonE]	[nonE]
None	None	None
[unit]	[ZEro]	[hoLd]
Unit switching	Zero setting	Display value hold
[dir]	[PCALL]	[dir]
Counting direction switching	Preset recall <sup>*1</sup>	Counting direction switching
[grAd]	—	[grAd]
Analog bar scale switching	—	Analog bar scale switching
[A.ctr]	—	[A.ctr]
Analog bar centering <sup>*2</sup>	—	Analog bar centering <sup>*2</sup>

\*1: Set the measurement origin by replacing the display value with the preset value.

\*2: By setting the analog bar scale, move the pointer display position to the center of the scale when the pointer is out of the display range, etc.

### 10) Setting the function lock

When function lock is executed, function lock display (🔒) will appear on the LCD and operations other than turning the power ON/OFF, holding/releasing the displayed value, outputting the displayed value, and canceling the Function Lock function will be disabled.

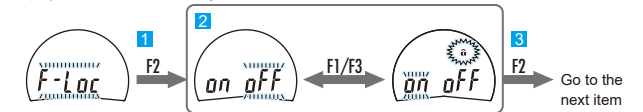

- 1 Press the [F2] key.  
⇒ Function Lock function can be set.
- 2 Press the [F1] key or [F3] key.  
⇒ Each time the key is pressed, the function lock turns ON/OFF alternately.
- 3 Press the [F2] key.  
⇒ Settings are confirmed; shifts to the next item.  
(Go to "11) Changing other functions".)

### Tips

- Function lock is enabled when exiting parameter setting mode and returning to measurement mode.
- To set an item for which the function has been locked, select [oFF] in step 2 and after function lock has been canceled, each setting can be changed.

### 11) Changing other functions

There are three types of parameter items in "Change other functions".

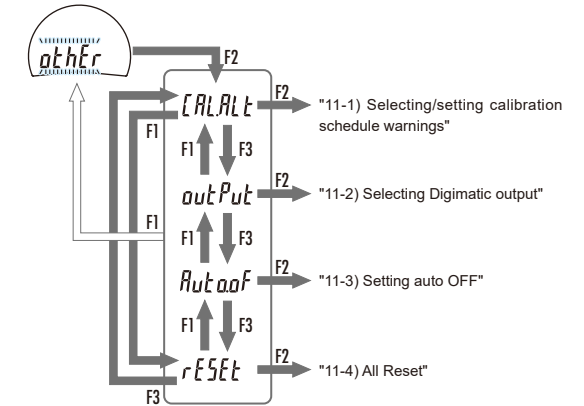

### 11-1) Selecting/setting calibration schedule warnings

By setting the current date, calibration date and advance warning date, the warning display (🔔) notifying the arrival of calibration schedule will blink/be lit on the LCD.

**When the current date is between the advance warning date and the calibration date:**

⇒ Warning display blinks.



**When the current date is after than the calibration date:**

⇒ The entire LCD blinks (warning display is lit).



#### Tips

- If the power is turned ON/OFF using the [F3] key, it is not necessary to reset the current date. However, if the battery is removed, the current date must be reset when the power is turned on again.
- Enable/disable calibration schedule warning function, current date, calibration date and advance warning date can be changed.

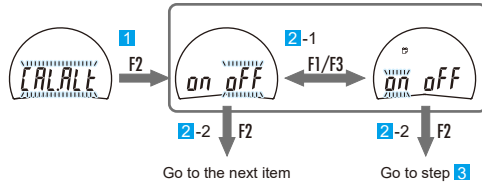

1 Press the [F2] key.

⇒ Calibration schedule warning can be set.

2 Select ON/OFF for the calibration schedule warning.

1 Press the [F1] key or [F3] key.

⇒ Each time the key is pressed, the calibration schedule warning turns ON/OFF alternately.

2 Press the [F2] key.

**If [on] is selected:**

⇒ The current date becomes settable and [todAY] blinks.

**If [oFF] is selected:**

⇒ Selection is confirmed; shifts to the next parameter item of "Other function changes".

(Go to "11-2) Selecting Digimatic output".)

#### Key icon operation

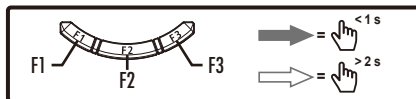

3 Set the current date.



3-1 ↓ F2



3-2 ↓ F2



3-3 ⋮

F1 ↓ F3

4. 2020

F1 ↓ F3

4. 2020

F1 ↓ F3

4. 2020

F1 ↓ F3

4. 2020

F1 ↓ F3

4. 2020

F1 ↓ F3

4. 2020

F1 ↓ F3

4. 2020

F1 ↓ F3

4. 2020

F1 ↓ F3

4. 2020

F1 ↓ F3

4. 2020

F1 ↓ F3

4. 2020

F1 ↓ F3

4. 2020

F1 ↓ F3

4. 2020

F1 ↓ F3

4. 2020

F1 ↓ F3

4. 2020

F1 ↓ F3

4. 2020

F1 ↓ F3

4. 2020

F1 ↓ F3

4. 2020

F1 ↓ F3

4. 2020

F1 ↓ F3

4. 2020

F1 ↓ F3

4. 2020

F1 ↓ F3

4. 2020

F1 ↓ F3

4. 2020

F1 ↓ F3

4. 2020

F1 ↓ F3

4. 2020

F1 ↓ F3

4. 2020

F1 ↓ F3

4. 2020

F1 ↓ F3

4. 2020

F1 ↓ F3

4. 2020

F1 ↓ F3

4. 2020

F1 ↓ F3

4. 2020

F1 ↓ F3

4. 2020

F1 ↓ F3

4. 2020

F1 ↓ F3

4. 2020

F1 ↓ F3

4. 2020

F1 ↓ F3

4. 2020

F1 ↓ F3

4. 2020

F1 ↓ F3

4. 2020

F1 ↓ F3

4. 2020

F1 ↓ F3

4. 2020

F1 ↓ F3

4. 2020

F1 ↓ F3

4. 2020

F1 ↓ F3

4. 2020

F1 ↓ F3

4. 2020

F1 ↓ F3

4. 2020

F1 ↓ F3

4. 2020

F1 ↓ F3

4. 2020

F1 ↓ F3

4. 2020

F1 ↓ F3

4. 2020

F1 ↓ F3

4. 2020

F1 ↓ F3

4. 2020

F1 ↓ F3

4. 2020

F1 ↓ F3

4. 2020

F1 ↓ F3

4. 2020

F1 ↓ F3

4. 2020

F1 ↓ F3

4. 2020

F1 ↓ F3

4. 2020

F1 ↓ F3

4. 2020

F1 ↓ F3

4. 2020

F1 ↓ F3

4. 2020

F1 ↓ F3

4. 2020

F1 ↓ F3

4. 2020

F1 ↓ F3

4. 2020

F1 ↓ F3

4. 2020

F1 ↓ F3

4. 2020

F1 ↓ F3

4. 2020

F1 ↓ F3

4. 2020

F1 ↓ F3

4. 2020

F1 ↓ F3

4. 2020

F1 ↓ F3

4. 2020

F1 ↓ F3

4. 2020

F1 ↓ F3

4. 2020

F1 ↓ F3

4. 2020

F1 ↓ F3

4. 2020

F1 ↓ F3

4. 2020

F1 ↓ F3

4. 2020

F1 ↓ F3

4. 2020

F1 ↓ F3

4. 2020

F1 ↓ F3

4. 2020

F1 ↓ F3

4. 2020

F1 ↓ F3

4. 2020

F1 ↓ F3

4. 2020

F1 ↓ F3

4. 2020

F1 ↓ F3

4. 2020

F1 ↓ F3

4. 2020

F1 ↓ F3

4. 2020

F1 ↓ F3

4. 2020

F1 ↓ F3

4. 2020

F1 ↓ F3

4. 2020

F1 ↓ F3

4. 2020

F1 ↓ F3

4. 2020

F1 ↓ F3

4. 2020

F1 ↓ F3

4. 2020

F1 ↓ F3

4. 2020

F1 ↓ F3

4. 2020

F1 ↓ F3

4. 2020

F1 ↓ F3

4. 2020

F1 ↓ F3

4. 2020

F1 ↓ F3

4. 2020

F1 ↓ F3

4. 2020

F1 ↓ F3

4. 2020

F1 ↓ F3

4. 2020

F1 ↓ F3

4. 2020

F1 ↓ F3

4. 2020

F1 ↓ F3

4. 2020

F1 ↓ F3

4. 2020

F1 ↓ F3

4. 2020

F1 ↓ F3

4. 2020

F1 ↓ F3

4. 2020

F1 ↓ F3

4. 2020

F1 ↓ F3

4. 2020

F1 ↓ F3

4. 2020

F1 ↓ F3

4. 2020

F1 ↓ F3

4. 2020

F1 ↓ F3

4. 2020

F1 ↓ F3

4. 2020

F1 ↓ F3

4. 2020

F1 ↓ F3

4. 2020

F1 ↓ F3

4. 2020

F1 ↓ F3

4. 2020

F1 ↓ F3

4. 2020

F1 ↓ F3

## 11-2) Selecting Digimatic output

For Code No. 547-251A, 547-252A, 547-257A and 547-258A, the data format setting for external output of displayed values can be changed. Select from DIGIMATIC d1 (6-digit output) or DIGIMATIC d2 (8-digit output).

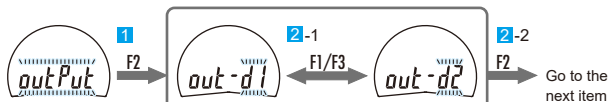

- 1 Press the [F2] key.  
⇒ Digimatic output selection can be set.
- 2 Select the data format for Digimatic output.
  - 1 Press the [F1] key or [F3] key.  
⇒ Each time the key is pressed, it will switch between [d1] and [d2].
  - 2 Press the [F2] key.  
⇒ Setting is confirmed; shifts to the next parameter item of "Other function changes". (Go to "11-4) All Reset".)

### Tips

Refer to "2) DIGIMATIC d1/d2 (output)" for details on the data format.

## 11-3) Setting auto OFF

The auto OFF function ON/OFF can be set. When set to ON, if there are no changes in measured values, key operation, or output requests over 20 minutes, the power will go OFF automatically.

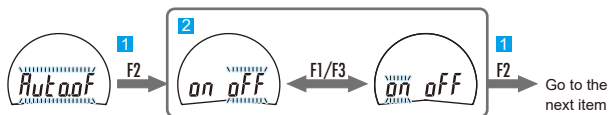

- 1 Press the [F2] key.  
⇒ Auto OFF setting is enabled.
- 2 Press the [F1] key or [F3] key.  
⇒ Each time the key is pressed, the auto OFF switches between ON and OFF.
- 3 Press the [F2] key.  
⇒ Settings are confirmed; shifts to the next parameter item. (Go to "11-4) All Reset".)

### Tips

- Auto OFF is enabled when exiting parameter setting mode and returning to measurement mode.
- To turn the power ON after auto OFF, press the [F2] key.
- The auto OFF function is disabled in parameter setting mode.

### Key icon operation

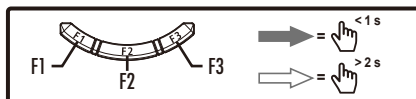

## 11-4) All Reset

All Reset will reset all settings of this product to default.

### Tips

- Once All Reset is executed, the previous settings will not be retrievable.
- Press the [F1] key to cancel partway through. Return to the previous step.
- Refer to "11. Setting Parameters" for default settings.

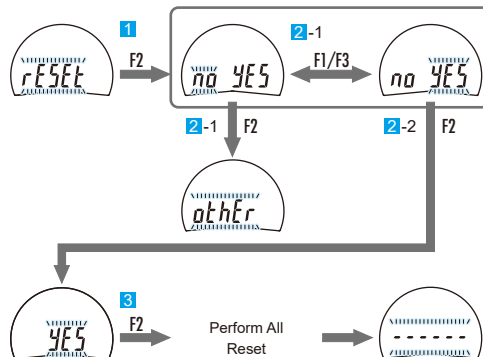

- 1 Press the [F2] key.  
⇒ All Reset can be executed.
- 2 Select whether to perform All Reset.
  - 1 Press the [F1] key or [F3] key.  
⇒ Each time the key is pressed, it will switch between [no] and [YES].
  - 2 Press the [F2] key.  
**If [YES] is selected: Confirms execution.**  
⇒ [YES] blinks.  
**If [no] is selected: Stops.**  
⇒ All Reset is canceled and the display returns to [othEr].
- 3 Press the [F2] key.  
⇒ [-----] blinks when All Reset is executed and completed.

## 12. Lifting Lever

### ● Mounting

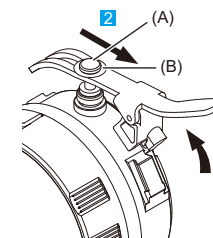

- 1 Raise the plunger and insert the tip of the lifting lever into the stop screw (A).

### Tips

When doing so, insert the tip of the lifting lever beneath the spacer (B).

- 2 Insert the groove on the lifting lever into the dovetail, and then move it in the direction indicated by the arrow to secure it.

### ● Removing

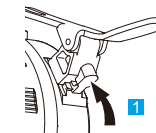













- 1 Raise the finger grip and remove the lifting lever.



## 13. Precautions after Use

- Clean the sliding surface of the plunger with a dry cloth or a cloth slightly moistened with alcohol. Do not lubricate the plunger at this time.
- When cleaning the display (LCD), wipe this product with a soft cloth moistened with diluted neutral detergent. Do not use an organic solvent such as thinner, which may cause the product to deform or malfunction.
- To prevent rust, apply a small amount of anti-rust oil to the contact point and bottom of the base prior to storage.
- The performance of this product is strongly influenced by usage and storage conditions. We recommend stipulating a maintenance cycle as in-house rules according to usage frequency, environment, storage method, etc., and inspecting the product periodically.
- If the product is to be out of use for 3 months or more, remove the battery before storage. Liquid leakage from the battery may damage the product.
- Do not store the product in a place with a high temperature or humidity, or a lot of dust or oil mist.

## 14. Error Displays and Countermeasures

Error Display	Cause	Countermeasures
ABS Synthesis Error 	The sensor signal cannot be synthesized.	Although this may occur during high-speed plunger movement, there is no effect on measurement. Use the product as is. * If it occurs while the plunger is not moving, the sensor may have failed. Please contact the agent where you purchased the product or Mitutoyo sales representative. (*18. Off-Site Repairs (Subject to Charge).*)
Battery Voltage Decrease Display 	Battery voltage is low.	Replace with a new battery.
Low Battery Voltage Error 	Cannot perform measurement because the battery is low.	Replace with a new battery.

Error Display	Cause	Countermeasures
Display Value Overflow Error 	The display value exceeds the displayable range.	When the display value returns to the number of displayable digits, the error is automatically cleared. • Reset the resolution. ("11. Setting Parameters", "5) Selecting the resolution".)
Sensor Contamination Detection Error 	A sudden change in temperature may create condensation on the detector, or it may be contaminated by other sources.	Although this may occur during high-speed plunger movement, there is no effect on measurement. Use the product as is. • If this occurs while the plunger is not moving, turn the power OFF and allow the product to adapt to the temperature for about 2 hours. • If it does not recover after adapting to the temperature, repair is required. Please contact the agent where you purchased the product or Mitutoyo sales representative. ("18. Off-Site Repairs (Subject to Charge)".)
Internal Connection Error 	There is a problem with the internal connection.	The product may be faulty. Please contact the agent where you purchased the product or Mitutoyo sales representative. ("18. Off-Site Repairs (Subject to Charge)".)
Serial Communication Forced Error 	A serial communication command [B7] (forced error display) is received.	Send a serial communication command [B8] (error reset).
Calibration Schedule Warning Forced Error 	A serial communication command [B9] (calibration schedule warning forced display) is received.	Send a serial communication command [B9] (calibration schedule warning forced display).
Set Value Rewrite Error 	For some reason, the set value has been rewritten since the previous use.	Press the [F1] key to return to measurement mode, check various settings, and reset where needed.
Set Value Storage Error 	Settings cannot be saved. The set values cannot be read.	• After turning OFF the power, turn ON the power again, check various set values, and reset where needed. • If the same error occurs even after the power is turned ON again, the product may be faulty. Please contact the agent where you purchased the product or Mitutoyo sales representative. ("18. Off-Site Repairs (Subject to Charge)".) • If the error occurs frequently, the supply voltage may be unstable. Check the supply voltage.
Internal Program Error 	Measurement cannot be done because of an internal program error.	The product may be faulty. Please contact the agent where you purchased the product or Mitutoyo sales representative. ("18. Off-Site Repairs (Subject to Charge)".)
Allowable Value Setting Error 	The upper limit value is set to a value smaller than the lower limit value.	Set the upper limit value to a value greater than the lower limit value (upper limit value > lower limit value). ("11. Setting Parameters", "6-2) Setting allowable values (upper limit value and lower limit value)".)
Calibration Date Setting Error 	The calibration date and advance warning date are set before the current date.	Set it so that current date < advance warning date < calibration date. ("11. Setting Parameters", "11-1) Selecting/setting calibration schedule warnings".)

Error Display	Cause	Countermeasures
Allowable Value (Upper Limit) Overflow Error 	The upper limit exceeds the displayable range.	• Reset the upper limit value. • Reset the resolution. ("11. Setting Parameters", "6-2) Setting allowable values (upper limit value and lower limit value)", "5) Selecting the resolution".)
Allowable Value (Lower Limit) Overflow Error 	The lower limit value exceeds the displayable range.	• Reset the lower limit value. • Reset the resolution. ("11. Setting Parameters", "6-2) Setting allowable values (upper limit value and lower limit value)", "5) Selecting the resolution".)
Preset Value Overflow Error 	The preset value exceeds the displayable range.	• Set the preset value again. • Reset the resolution. ("2) For absolute measurement (ABS)", "11. Setting Parameters", "5) Selecting the resolution".)

## 15. Input/Output Functions

For input/output functionality, the product has both DIGIMATIC d1/d2 (output) and DIGIMATIC S1 (input/output).

- DIGIMATIC d1: 6-digit output for Mitutoyo DIGIMATIC products
- DIGIMATIC d2: 8-digit output for Mitutoyo DIGIMATIC products
- DIGIMATIC S1: Bidirectional serial I/O for Mitutoyo DIGIMATIC products

### Tips

DIGIMATIC S1 is our in-house own bidirectional serial communication.

It can be used by connecting a PC with USB-ITPAK V3.0 (Part No. 06AGR543) measurement data collection software installed, to this product.

\*Use the dedicated options below (VCP driver installation required).

- Measurement Data Input Unit: IT-020U (Part No. 264-020)
- Measurement Data Input Unit USB Direct Input Tool: USB-ITN-SF (Part No. 06AGQ001F)

### 1) I/O connector

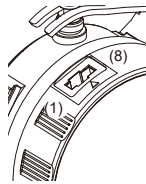

Pin No.	DIGIMATIC d1/d2	
	Signal	I/O
(1)	GND	-
(2)	DATA	O
(3)	CK	O
(4)	RD	O
(5)	REQ	I
(6)	N.C.	-
(7)	N.C.	-
(8)	N.C.	-

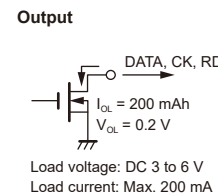
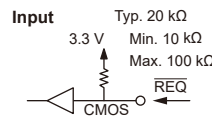

## 2) DIGIMATIC d1/d2 (output)

DIGIMATIC d1/d2 output the displayed value data for the REQ signal to the external device.

### Data format

#### ● DIGIMATIC d1

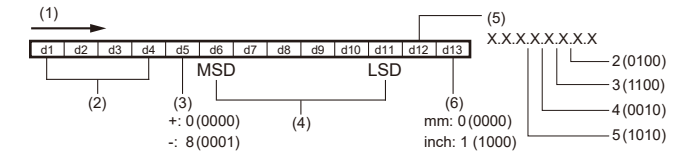

- (1) Output order  
Each digit: d1 → d13  
Each bit within one digit:  
bit0 → bit3
- (2) All "F(1111)"
- (3) Sign  
(4) Measured value (6 digits)  
(5) Decimal point  
(6) Units

Example: 123.456 mm

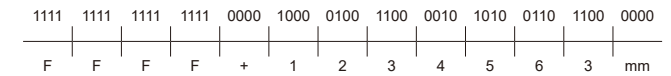

#### ● DIGIMATIC d2

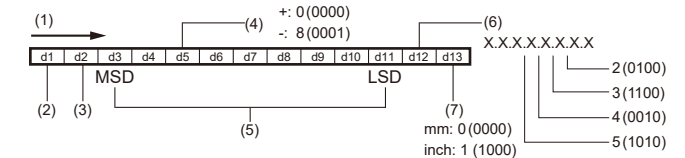

- (1) Output order  
Each digit: d1 → d13  
Each bit within one digit:  
bit0 → bit3
- (2) Data format: 8 (0001)  
(3) F (1111)
- (4) Sign  
(5) Measured value  
(8 digits: d3 to d4, d6 to d11)  
(6) Decimal point  
(7) Units

Example: -1234.5675 mm

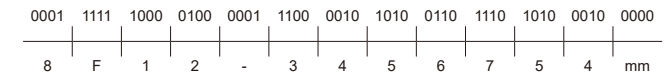

### Timing chart

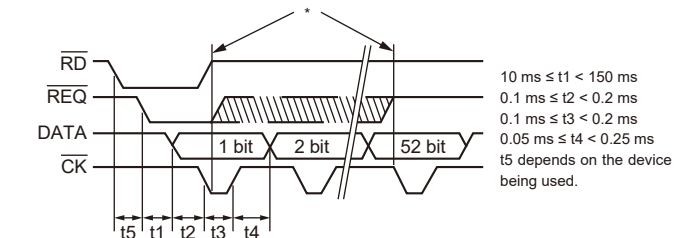

\*Keep REQ at Low until CK is output.  
Return it to High before the final CK output is completed (52nd bit).

## 16. Specifications

Protection level *1	IP42 equivalent *2
CE marking/UKCA marking	EMC Directive/Electromagnetic Compatibility Regulation: EN IEC 61326-1 Immunity test requirements: Clause 6.2 Table 2 Emission limit: Class B RoHS Directive/Regulation Restricting Use of Specified Hazardous Substances in Electric/Electronic Devices: EN IEC 63000
Power supply	Lithium metal battery CR2032 (3.0 V)
Battery life *3	Standard usage: Approx. 2.5 years, 2,700 hours in continuous use
Scale	Electrostatic capacitance type absolute linear encoder
Response speed	Unlimited (unavailable for scanning measurement)
Data output	DIGIMATIC d1, DIGIMATIC d2
I/O	DIGIMATIC S1
Temperature range	Operation: 0 °C to 40 °C, storage: -10 °C to 60 °C
Standard accessories	Lithium metal battery CR2032 (to confirm functionality, qty: 1), Extension rod, Battery holder opener (Part No. 21EAB049), User's manual with warranty

\*1: The protection level (IP: International Protection) is based on IEC 60529/JIS C 0920.

\*2: Values are for factory conditions.

\*3: The battery life varies depending on usage times and conditions. The above values are guidelines.

## 17. Accessories (Optional)

- Connection cable: Part No. 06AGL011 (1 m, flat straight)
- Connection cable: Part No. 06AGL021 (2 m, flat straight)

\*For accessories (optional) other than the above, refer to the Measuring Instruments Catalog.

\*If parallelism is required when replacing with a flat-tipped contact point, the product parallelism must be adjusted, including the indicator.

Consult with us to place a special order when required.

## 18. Off-Site Repairs (Subject to Charge)

Off-site repair (subject to charge) is required in the case of the following malfunctions. Please contact the agent where you purchased the product or Mitutoyo sales office.

- Poor plunger operation
- Poor accuracy
- [E] is displayed as the last digit when the plunger is stationary
- Abnormal measured value or LCD trouble
- No recovery from [Err 40]
- No recovery from [Err 41]
- No recovery from [Err 63]
- Power will not turn on

\*If the fundamental structural components or multiple components need to be replaced, we reserve the right to decline the repair.