



# Digimatic Height Gage

HDM-30AX / HDM-60AX / HDM-100AX / HD-30AX / HD-60AX / HD-100AX /  
 HDM-12"AX / HDM-18"AX / HDM-24"AX / HDM-40"AX / HD-12"AX / HD-18"AX /  
 HD-24"AX / HD-40"AX

## Safety Precautions

To ensure operator safety, use this product in conformance with the directions, functions and specifications given in this User's Manual. Use under other conditions may compromise safety.

### WARNING

- Always keep batteries out of reach of children, and if swallowed, consult a physician immediately.
- Batteries should never be short-circuited, disassembled, deformed or come in contact with extreme heat or flames.
- If battery alkaline liquid comes in contact with the eyes, flush eyes immediately with clean water and consult a physician. If battery alkaline liquid comes in contact with the skin, flush the exposed area thoroughly with clean water.

### CAUTION

- Never attempt to charge the primary battery or reverse the positive-negative terminals when mounting. Improper battery handling or mounting may cause the battery to explode, cause battery leakage and/ or serious bodily injury or malfunctioning.
- The tip of the scriber on this product is sharp. Always handle with care to avoid injury.

### NOTICE

- If the product is to be out of use for a long period of time, remove the battery before storage. Liquid leakage from the battery may damage the product.
- Be sure to use an SR44 battery (silver oxide battery).
- Never disassemble this product, unless removing the battery cover to replace the battery.
- Be sure that you thoroughly understand the content in both "2. Installation Environment" and "3. Precautions for Use" before using this product.

## Contents

1. Product Capabilities .....	Page 1
2. Installation Environment.....	Page 1
3. Precautions for Use.....	Page 1
4. Confirmation of Accessories.....	Page 1
5. Names and Functions of Components.....	Page 2
6. Preparations before Use .....	Page 2
7. Moving the Slider Vertically.....	Page 3
8. Using as a Scribing Tool.....	Page 3
9. Using as a Measuring Instrument.....	Page 3
10. Usage Scenarios.....	Page 5
11. Routine Maintenance .....	Page 5
12. Troubleshooting.....	Page 5
13. Specifications.....	Page 6
14. Options (Sold Separately).....	Page 6

## 1. Product Capabilities

- This product can scribe precisely on surfaces of workpiece (①) with the tip of a part called a scriber. It can also work as a height measuring instrument, by touching the scriber to the point (②) to be measured a height (③).

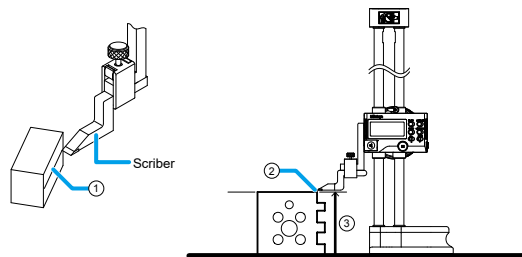

- HDM Series models can measure both the inner width (④) and outer width (⑤) along with the height by changing the scriber to an optional bidirectional touch-trigger probe (sold separately).

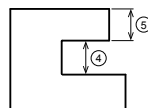

## 2. Installation Environment

Only use this product in the following environments.

- Areas with minimal dirt and dust
- Areas with minimal vibrations
- Areas with an ambient temperature between 0 °C and 40 °C (For precision measurements, the temperature should be consistently around 20 °C.)
- Areas with low humidity
- On a surface plate

Avoid using the product in the following environments.

- In locations where it may be directly exposed to cutting fluids, water, etc.
- In locations where it may be exposed directly to sunlight or hot or cold wind
- In locations near machines that generate electromagnetic noise, such as welders or electrical discharge machines

## 3. Precautions for Use

### 1) When using the product for the first time

Wipe the rust preventive oil from the product with a soft cloth soaked with cleaning oil, etc., and then install the supplied battery.

### 2) Cleaning before use

Clean the following parts, and then use the product only after confirming that it is free of dirt or burrs (projections caused by damage, etc.).

- Surface plate
- Columns, lower base surface, scriber mounting surface, and scriber measurement surface

## 3) When carrying or moving

### Correct holding

- First lock the slider securely in place, and be sure to hold the bottom of the base while lightly supporting the rear surface of the slider.

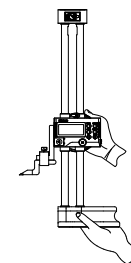

- When measuring or moving on a surface plate, grip the base and slide it to move.

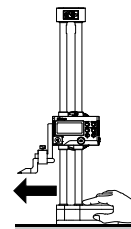

### Incorrect holding

#### NOTICE

Do not hold the column or column head or carry it while suspended, as doing so could affect accuracy.

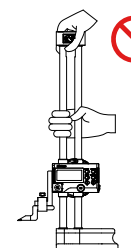

## 4) Other

#### NOTICE

- Never apply an external voltage to this product, such as entering numbers using an electric marking pen. This may cause damage.
- Do not subject the product to excessive force or impact through dropping or the like.

## 4. Confirmation of Accessories



• Scriber (for HD Series)

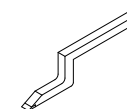

• Scriber (for HDM Series)

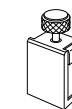

• Scriber clamp

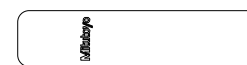

• Dust cover

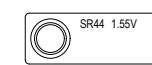

• Battery (SR44)

• Manual (this document) and warranty

## 5. Names and Functions of Components

### 1) Main body

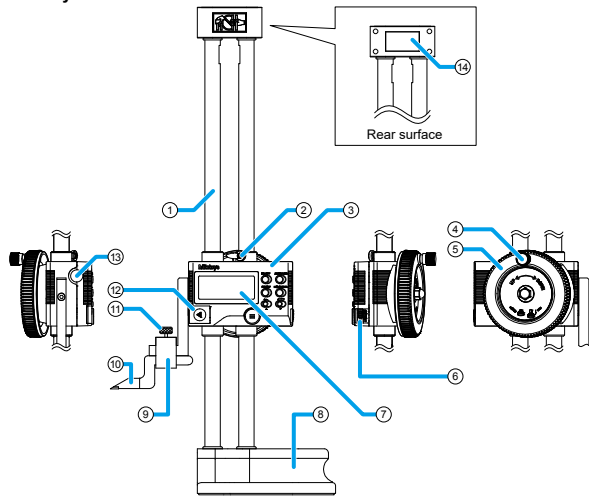

- ① Column  
Supports the slider.
- ② Slider clamp  
Locks/unlocks the slider movement.
- ③ Slider  
The moving part on the main body in which the LCD display and controls are located.
- ④ Fine-adjustment knob  
The knob can switch coarse/fine movement to allow both fast feed and accurate fine adjustment of the slider.
- ⑤ Feed handle  
Turning it left/right coarsely moves the slider vertically.
- ⑥ Output connector  
This connector is used to connect an optional external device (sold separately).
- ⑦ LCD display  
The display is used to show measured values and messages.
- ⑧ Base  
It grips when measuring or moving the main body on a surface plate.
- ⑨ Scriber clamp  
Fixes the inserted scriber to the main body with the clamp screw.
- ⑩ Scriber  
A tool used to make scribe lines. It can also be used to measure heights by touching it to the point to be measured.
- ⑪ Clamp screw  
The screw which fixes the scriber.
- ⑫ Battery cover  
Covers the battery case.
- ⑬ Bidirectional touch-trigger probe connector (HDM Series only)  
This connector is used to connect an optional bidirectional touch-trigger probe (sold separately).
- ⑭ Label  
Indicates product information such as code No.

### 2) Controls

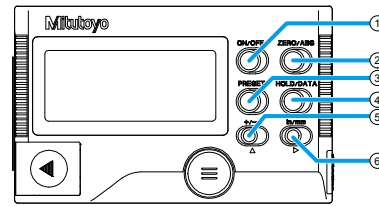

- ① [ON/OFF] switch  
Used to turn the power on/off.
- ② [ZERO/ABS] switch  
Used to switch between absolute measurement (ABS) and incremental measurement (INC).
- ③ [PRESET] switch (HD Series)/[MODE] switch (HDM Series)  
Used for the following:
  - To set preset value
  - To set ball diameter (HDM Series only)
- ④ [HOLD/DATA] switch  
Used to hold the measured value display or to output measurement results to an optional external device (sold separately).
- ⑤ [+/-] / [▲] switch  
Used for the following:
  - To set preset value
  - To set ball diameter (HDM Series only)
  - To switch counting direction and resolution
- ⑥ [in/mm] / [▶] switch  
Used for the following:
  - To set preset value
  - To set ball diameter (HDM Series only)
  - To switch resolution
  - To switch units (in/mm)

### 3) LCD display

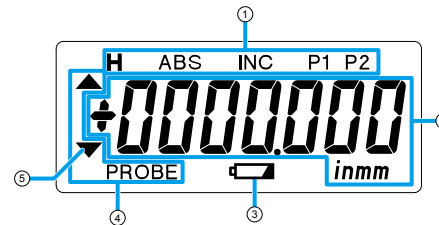

- ① Lights up as follows during the following operations:
  - [H]  
When the measured value is being held in the display.
  - [ABS]/[INC]  
When switching the measurement mode between absolute measurement (ABS) and incremental measurement (INC)
  - [P1]/[P2]  
When the reference has been set to an arbitrary value.
- ② Displays the measured value and unit.
- ③ Lights up when the battery is depleted.
- ④ Blinks when setting the ball diameter (HDM Series only).
  - [PROBE]  
When starting ball diameter setting or when displaying the correction value of ball diameter.
  - [▼]  
When waiting for ball diameter bottom side measurement.
  - [▲]  
When waiting for ball diameter top side measurement.
- ⑤ Lights up when the counting direction is set to negative.

## 6. Preparations before Use

### 1) Installing (replacing) the battery

- 1 Turn the power off, and then slide the battery cover in the direction of the arrow to remove it from the battery case.
- 2 Insert the new battery (SR44 part No. 938882) with the plus side facing upward.
- 3 Slide the battery cover back into place.
  - › The screen blinks [-----].
- 4 Press either the [PRESET] switch or the [MODE] switch.
  - › The value [0.00] lights up. (On inch display models, [0.0000] lights up.)

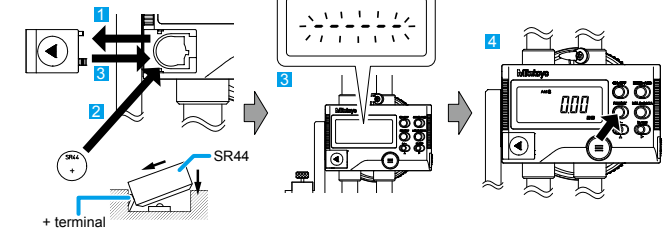

#### NOTICE

When inserting the battery, be careful not to crush the + terminal.

#### Tips

- When replacing the battery, wait at least 10 seconds before inserting the new battery.
- If the display or functionality is abnormal after replacing the battery, reinstall the battery.
- Pressing the [ON/OFF] switch will turn the power off. Always turn the power off when you are finished using the product.

### 2) Mounting the scriber

- 1 Insert the scriber clamp all the way to the end of the jaw.
- 2 Insert the scriber into the scriber clamp.
- 3 Tighten the clamp screw.

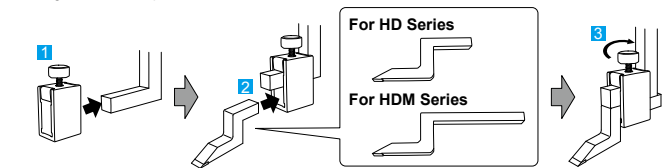

#### NOTICE

Mount the scriber as close to the column as possible, so that it protrudes no more than necessary. Too much protrusion will cause measurement errors (with error effect increased 1.5 times if the protrusion of the scriber tip from the column changes from 100 mm to 150 mm). If the scriber must be used protruding longer, be careful to apply only the necessary measuring force.

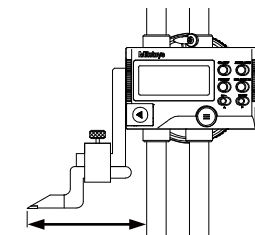

## 7. Moving the Slider Vertically

Loosen the slider clamp so that the slider can be moved.

When moving the slider vertically, hold the base surface down with the palm of one hand as you turn the feed handle right or left with the other hand.

Moving the slider will move the scriber up and down.

Move the slider slowly when bringing the scriber into contact with the surface plate or workpiece.

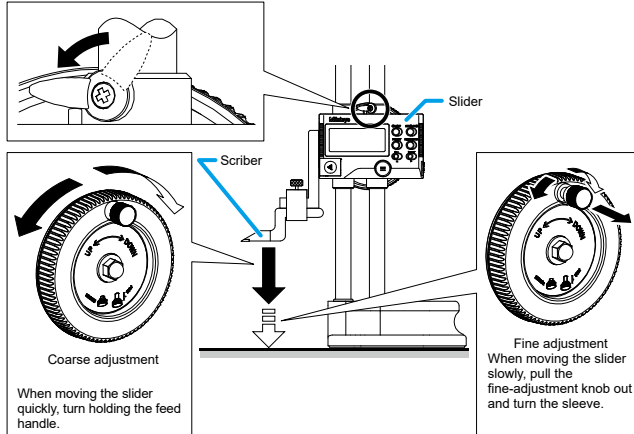

### NOTICE

If the slider is moved further (measuring force is applied) after the scriber makes contact with the workpiece, the bottom of the base will lift from the surface plate, causing measurement errors. In order to obtain accurate measurements, bring the scriber into contact with the workpiece as slowly as possible and apply constant force lightly. Before measuring, confirm that the bottom of the base is free of dirt and burrs (burr caused by damage, etc.).

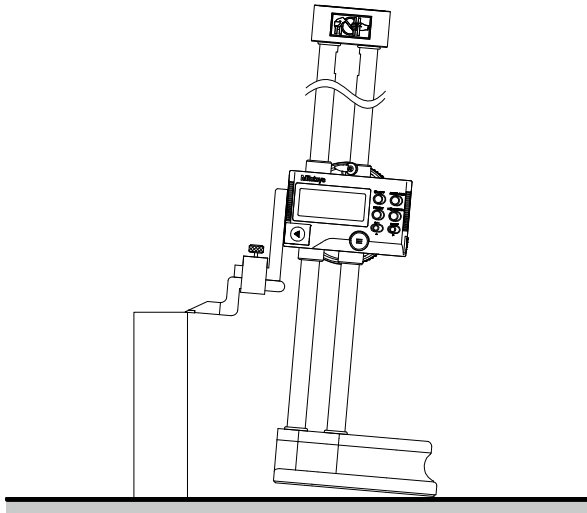

### Tips

- When bringing the scriber into contact with the workpiece, you can confirm the scriber contact state and close contact of base and surface plate by sliding the base slightly over the surface plate once the slider has stopped moving.
- In order to make accurate measurements, bring the scriber into contact with the workpiece several times and confirm that the LCD shows a stable value when the scriber makes contact with the workpiece.

## 8. Using as a Scribing Tool

When scribing, make sure that the scriber moves in a consistent direction. Make sure that the slider clamp is firmly tightened and that the slider is fixed.

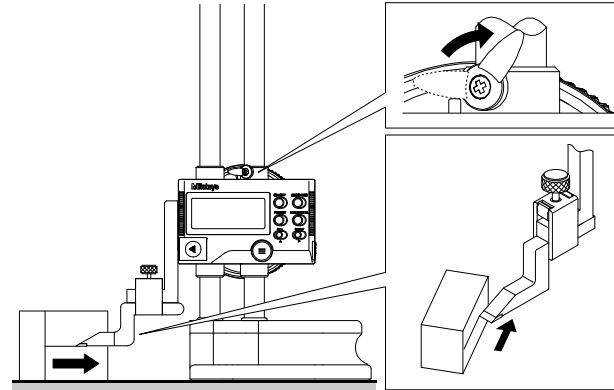

### Tips

When setting the reference, refer to "1) Reference setting".

## 9. Using as a Measuring Instrument

### 1) Reference setting

Set the reference when measuring height. The distance from the reference set will be displayed as a measured value of height. This product supports both absolute measurement (ABS) and incremental measurement (INC) reference setting, as well as preset reference setting. Use the appropriate setting for your application.

### Tips

If using a bidirectional touch-trigger probe (HDM Series only), set the ball diameter before setting the reference (refer to "■ Ball diameter setting" for information on setting the ball diameter).

### ■ Reference (zero) setting for absolute measurement (ABS)

This method is used to set the reference for absolute measurement. Normally, the workpiece height is measured with the surface plate surface as the reference. The set reference is fixed until the power is turned off, so this is a convenient way to measure multiple measurement points with the surface plate surface as the reference.

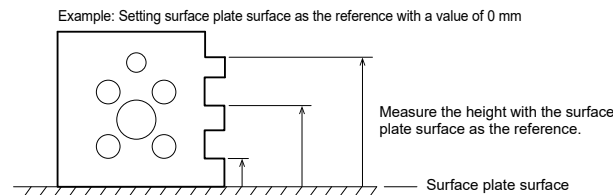

As an example, this section describes how to set the surface plate surface as the reference.

### Tips

The set reference is stored until the power is turned off. If the power is turned off, the reference must be set again.

### ● If using a scriber

The position of the slider when the power was turned on is set as the reference.

- 1 Confirm that the power is off.
- 2 Slowly bring the scriber into contact with the surface plate.
- 3 Press the [ON/OFF] switch.
  - › The value [0.00] lights up (the reference for ABS has been set).



### ● If using a bidirectional touch-trigger probe (HDM Series only)

- 1 Press the [ON/OFF] switch.
  - › [ABS] blinks.
- 2 Slowly bring the probe tip ball into contact with the surface plate, until it beeps.
  - › [H], [ABS], and the value [0.00] light up (the reference for ABS has been set).



### ■ Reference (zero) setting for incremental measurement (INC)

This method is used to set an arbitrary point on the workpiece as the reference. The specified point will be used as the reference for measurement (value of 0 mm). As the reference is reset each time the switch is pressed, this is a convenient way to measure multiple measurement points while resetting the reference.

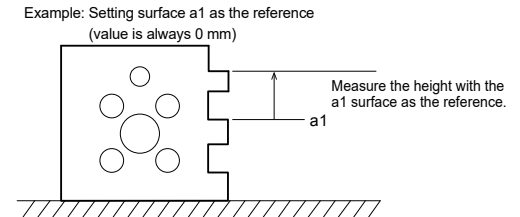

### ● If using a scriber

- 1 Press the [ON/OFF] switch.
- 2 Slowly bring the scriber into contact with an arbitrary point on the workpiece.
- 3 Press the [ZERO/ABS] switch.
  - › The value [0.00] lights up (the reference for INC has been set).

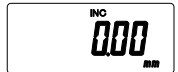

### ● If using a bidirectional touch-trigger probe (HDM Series only)

- 1 Press the [ON/OFF] switch.
  - › [ABS] blinks.
- 2 Slowly bring the probe tip ball into contact with an arbitrary point, until it beeps.
  - › [H], [ABS], and the value [0.00] light up.
- 3 Move the ball away from the workpiece, and then press the [ZERO/ABS] switch.
  - › [INC] blinks.
- 4 Slowly bring the probe tip ball into contact with an arbitrary point, until it beeps.
  - › [H], [INC], and the value [0.00] light up (the reference for INC has been set).

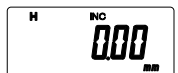

### Tips

To stop setting the reference, press the [ZERO/ABS] switch.

### Reference (arbitrary value) presetting

This product allows the reference to be set (preset) at any value to any arbitrary point. Up to two references can be preset.

As an example, this section describes how to set the preset value to [P1] (preset 1) using a 25 mm gauge block.

#### Tips

The set preset value is retained even when the power is turned off. However, the preset value will be cleared if the battery is replaced, and will be need to be set again.

- Press either the [PRESET] switch or the [MODE] switch.
  - The previous preset value is displayed, and [P1] blinks on the upper right of the LCD.



#### Tips

- To set the displayed preset value as the reference, proceed to step 7.
- Pressing the [▲] switch switches between [P1] and [P2] on the display.
- Although the reference can be preset even when displaying INC, the reference for INC will reset to 0 mm each time the measurement mode is changed (the preset value is not stored).

- Press the [▶] switch.
  - [+] blinks.
  - When [-] is blinking, press the [▲] switch to change to [+] blinking.



- Press the [▶] switch repeatedly until the number in the tens place blinks.



- Press the [▲] switch repeatedly until the number in the tens place reads [2].
  - The number will switch from 0 through 1, 2...8, 9, and then back to 0, so press it twice.



- Use the same procedure in steps 3 and 4 to change the number in the ones place to [5].



- Press the [▶] switch repeatedly until [P1] blinks.



- Slowly bring the scriber, test indicator, or probe tip ball into contact with the 25 mm gauge block.
  - If using a probe, [P1] lights up (setting is complete).



- Press either the [PRESET] switch or the [MODE] switch.
  - [P1] lights up (setting is complete).



#### Tips

To exit the presetting (P1/P2 display), press the [ZERO/ABS] switch. The measurement mode shifts to INC.

### 2) Switching measurement modes

- Press the [ZERO/ABS] switch.
  - The value [0.00] lights up (the measurement mode has been switched to INC).



- Press and hold the [ZERO/ABS] switch for at least two seconds.
  - [INC] goes out and [ABS] lights up (the measurement mode has been switched to ABS).

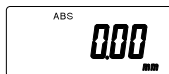

#### Tips

When the reference setting is changed from INC to ABS, the slider position compared to the reference set with ABS will be displayed.

### 3) Measuring with the scriber

<Example> Measuring dimensions A and B of the workpiece shown in the figure at right

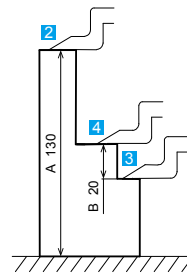

- Set the surface plate surface as the reference for ABS.

#### Tips

Refer to "Reference (zero) setting for absolute measurement (ABS)" for information on setting.



- Slowly bring the scriber into contact with the upper surface A.
  - Dimension A is measured.



- Set the lower surface B as the reference for INC.

#### Tips

Refer to "Reference (zero) setting for incremental measurement (INC)" for information on setting.

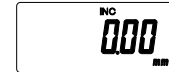

- Slowly bring the scriber into contact with the upper surface B.
  - Dimension B is measured.



### 4) Measuring with the bidirectional touch-trigger probe (HDM Series only)

#### NOTICE

Kindly read this section along with the User's Manual for the bidirectional touch-trigger probe.

#### Ball diameter setting

The height is measured by the displacement of the ball bottom side of the probe tip (refer to the figure at left below).

When measuring height by making contact with the ball top side, the height is determined by adding the ball diameter to the displacement of the ball bottom side (refer to the figure at right below).

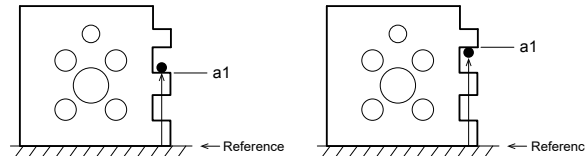

Height of surface a1: Displacement of ball bottom side    Height of surface a1: Displacement of ball bottom side + ball diameter

Therefore, the ball diameter must be measured and registered beforehand. Always perform this setting when using the product for the first time, after replacing its battery, or after replacing the probe. Measuring the inner or outer width without setting first will lead to serious measurement error.

This section describes how to measure the ball diameter. Two 20 mm or larger gauge blocks are required (any size that meets this requirement may be used).

- Press and hold the [MODE] switch for at least two seconds.
  - [PROBE] blinks ([0.00 mm] lights up when the first time the product is used).

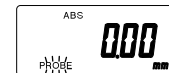

- Press the [▶] switch.
  - [▼] blinks.



- Wring the gauge blocks together slightly off from each other so that the probe tip ball can make contact with them.

- Slowly bring the ball into contact with gauge block B, until it beeps.
  - [▲] blinks.

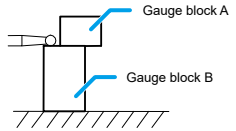

- Slowly bring the ball into contact with gauge block A, until it beeps.
  - [PROBE] blinks (the correction value is displayed).

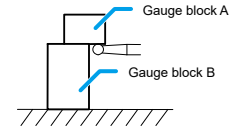

- Press the [ZERO/ABS] switch.
  - The ball diameter has been set.

#### NOTICE

- The nominal ball diameter and the measured value will not necessarily be the same.
- When measuring, the measured value is displayed after computing the ball diameter. The display value may therefore seem to jump the instant the ball is brought into contact with the workpiece and beeps. However, this is not a malfunction.

#### Reference setting

As an example, this section describes how to set the preset value to [P1] (preset 1) using a 50 mm gauge block.

- Set the preset value to 50 mm, and cause [P1] to blink.

#### Tips

Refer to "Reference (arbitrary value) presetting" for information on setting.

- Slowly bring the probe tip ball into contact with the gauge block, until it beeps.
  - [P1] lights up (the reference has been set as 50.00 mm at the height of the gauge block).

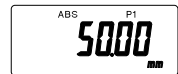
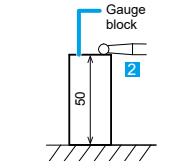

## ■ Measuring the workpiece

<Example> Measuring dimensions A, B, C, and D of the workpiece shown in the figure at right

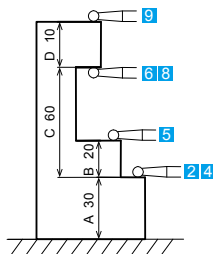

1) Set the surface plate surface as the reference for ABS.

### Tips

Refer to "■ Reference (zero) setting for absolute measurement (ABS)" for information on setting.

2) Slowly bring the probe tip ball into contact with the upper surface A, until it beeps.  
 > Dimension A is measured.

3) Move the ball away from the workpiece, and then press the [ZERO/ABS] switch.  
 > [INC] blinks.

4) Slowly bring the ball into contact with the lower surface B, until it beeps.  
 > The height of the lower surface B is set as [0.00 mm] (reference for INC).

5) Slowly bring the ball into contact with the upper surface B, until it beeps.  
 > Dimension B is measured.

6) Slowly bring the ball into contact with the upper surface C, until it beeps.  
 > Dimension C is measured.

7) Move the ball away from the workpiece, and then press the [ZERO/ABS] switch.  
 > [INC] blinks.

8) Slowly bring the ball into contact with the lower surface D, until it beeps.  
 > The height of the lower surface D is set as [0.00 mm] (reference for INC).

9) Slowly bring the ball into contact with the upper surface D, until it beeps.  
 > Dimension D is measured.

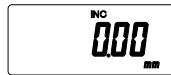
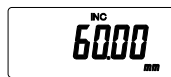
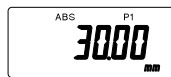

## 10. Usage Scenarios

### 1) Switching the counting direction

The counting polarity can be switched by pressing the [+/-] switch.

1) Press the [+/-] switch.  
 > [▼] lights up (when the slider moves up, it counts in the negative direction).



2) Press the [+/-] switch again.  
 > [▼] goes out (when the slider moves up, it counts in the positive direction).



### Tips

If a preset value was used to set the reference, pressing the [+/-] switch after moving the slider will change the display value. For example, if the slider is raised 3 mm from the 25 mm point, the display value will be 28 mm. If the counting direction is switched to negative at this point, the display value will change to 22 mm. This is the result of counting in the negative direction from the 25 mm point. Press the [ZERO/ABS] switch before resetting the preset value.

### 2) Setting the resolution

The resolution can be switched by pressing the following switches (For metric display: 0.01 mm ⇔ 0.005 mm; for inch display: 0.0005 in ⇔ 0.0002 in).

### Tips

Upon purchase, the display is set to [0.01 mm] for metric and [0.0005 in] for inches.

1) Press and hold the [▲] switch and [▶] switch together for at least two seconds.  
 > The resolution is shown up to three digits after the decimal point.



2) Press and hold the [▲] switch and [▶] switch together again for at least two seconds.  
 > The resolution is shown up to two digits after the decimal point.



### 3) Holding the displayed measurement result

The displayed measurement result can be held even if the slider is moved.

1) Press the [HOLD/DATA] switch.  
 > [H] lights up (displayed measurement result is held).



2) Press the [HOLD/DATA] switch again.  
 > [H] goes out (displayed measurement result is released).



### Tips

If an external device is connected to the output connector on the product, the [HOLD/DATA] switch will instead be used as a switch for outputting measured value.

### 4) Outputting measurement results to an external device

Measured values can be output to an optional external device (sold separately) connected to the product.

1) Connect the external device to the output connector on the product.

2) Press the [HOLD/DATA] switch.

### Tips

- Measured values can also be output by operating the external device. Refer to the User's Manual included with the external device for details.
- When using a bidirectional touch-trigger probe (HDM Series only), the measured value will be automatically output once the probe tip ball makes contact with the workpiece.

## 11. Routine Maintenance

### 1) Cleaning

- After use, clean the entire product and check that none of the parts are damaged.
- Use a lint-free cloth or paper soaked in alcohol to wipe the column, base, scriber, and display panel clean. Do not use thinner or other organic solvents. Use an old toothbrush or the like to clean the rack part of the column.
- If the main body is dirty, use a lint-free cloth or paper soaked in neutral detergent to wipe it clean. \*Do not use solvent or similar substances, as they could damage the coating.

### 2) Storage

- When storing the product, leave the scriber hanging around 1 mm from the surface plate surface, and do not tighten the slider clamp.
- Store so that the tip of the scriber does not protrude from the surface plate.
- Always turn the power off before storing.
- Do not store the product in a place with a high temperature or humidity, or a lot of dust or oil mist.
- If the product is to be out of use for a long period of time, remove the battery.
- After using the product, we recommend covering it with the included dust cover to protect it from dust.
- We recommend periodically testing and calibrating the product for accuracy.
- If any abnormalities occur, contact the dealer where the product was purchased.

## 12. Troubleshooting

If a problem occurs while using this product, please try one of the solutions provided below. If the solution does not work, contact our service department via your dealer for repair.

### 1) If the following problem occurs

Problem	Cause	Solution
<ul style="list-style-type: none"> <li>• The displayed values flicker or disappear temporarily.</li> <li>• An accurate measurement result cannot be obtained.</li> <li>• The power is turned off automatically.</li> </ul>	The product is used in environments where electromagnetic interference exceeds requirements defined in the EMC Directive.	<ul style="list-style-type: none"> <li>• The product will return to normal after removing the electromagnetic interference caused by electrostatic discharge.</li> <li>• If this problem is due to electromagnetic interference acting on the AC or DC power line, check the circumference of the power line, and then make a measurement again.</li> <li>• If a brownout occurs, the product will return to normal after the recovery from the low voltage.</li> </ul>

### 2) If a warning is displayed

Warning	Cause	Solution
Err-oS	<ul style="list-style-type: none"> <li>• Noise generated.</li> <li>• The slider was moved too quickly.</li> </ul>	Turn the power off and then back on again, and then set the reference.
Err-oF	The measured value exceeds the number of digits that can be displayed.	Counting will start again if the slider is moved back into the display range. Set the preset, and then set the correct reference.
Err-oP	<ul style="list-style-type: none"> <li>• The probe was touched by accident.</li> <li>• The slider was moved too quickly when making contact with the workpiece.</li> </ul>	This will normally be resolved automatically. If not, turn the power off and then back on again, and then set the reference.
	Battery is depleted.	Replace with a new battery.
H display blinking	<ul style="list-style-type: none"> <li>• The probe was touched by accident.</li> <li>• Contact time with the workpiece was insufficient.</li> </ul>	<ul style="list-style-type: none"> <li>• Press the [HOLD/DATA] switch to cancel.</li> <li>• When measuring, have the probe tip ball make contact with the workpiece for at least 0.2 seconds.</li> </ul>
<ul style="list-style-type: none"> <li>• Err--S</li> <li>• Err--d</li> <li>• Err--G</li> <li>• Err--o</li> </ul>	Sensor setting malfunction has occurred.	Press either the [PRESET] switch or the [MODE] switch. If the error message does not disappear, reinstall the battery and try again. If the error message still does not disappear, remove the battery and contact your dealer or our sales office.

## 13. Specifications

### 1) Product specifications

#### ● HD Series (HD-30AX/HD-60AX/HD-100AX)

Model number	HD-30AX	HD-60AX	HD-100AX
Code No.	192-613-10	192-614-10	192-615-10
Maximum measurement length	300 mm	600 mm	1000 mm
Maximum permissible error (E <sub>MPE</sub> )	± 0.02 mm	± 0.05 mm	± 0.07 mm
Resolution	0.01 mm/0.005 mm		
Maximum response speed	Approx. 500 mm/s		
Power	SR44 (silver oxide battery) x1 (part No.938882)		
Battery life	Approx. 3,500 hours		
Operating temperature	0 °C to 40 °C		
Storage temperature	-10 °C to 60 °C		
Dust cover	Part No.450291	Part No.450292	Part No.450290
Scriber	Part No.07GZA000		
Scriber clamp	Part No.05GZA033		

#### ● HD Series (HD-12"AX/HD-18"AX/HD-24"AX/HD-40"AX)

Model number	HD-12"AX	HD-18"AX	HD-24"AX	HD-40"AX
Code No.	192-630-10	192-631-10	192-632-10	192-633-10
Maximum measurement length	300 mm/12"	450 mm/18"	600 mm/24"	1000 mm/40"
Maximum permissible error (E <sub>MPE</sub> )	± 0.02 mm ± 0.001"	± 0.05 mm ± 0.002"	± 0.05 mm ± 0.002"	± 0.07 mm ± 0.003"
Resolution	0.01 mm/0.005 mm/0.0005"/0.0002"			
Maximum response speed	Approx. 500 mm (19.7 in)/s			
Power	SR44 (silver oxide battery) x1 (part No.938882)			
Battery life	Approx. 3,500 hours			
Operating temperature	0 °C to 40 °C			
Storage temperature	-10 °C to 60 °C			
Dust cover	Part No.450291	Part No.450292	Part No.450292	Part No.450290
Scriber	Part No.900258			
Scriber clamp	Part No.901385			

#### ● HDM Series (HDM-30AX/HDM-60AX/HDM-100AX)

Model number	HDM-30AX	HDM-60AX	HDM-100AX
Code No.	192-663-10	192-664-10	192-665-10
Maximum measurement length	300 mm	600 mm	1000 mm
Maximum permissible error (E <sub>MPE</sub> )	± 0.02 mm	± 0.04 mm	± 0.06 mm
Resolution	0.01 mm/0.005 mm		
Maximum response speed	Approx. 500 mm/s		
Power	SR44 (silver oxide battery) x1 (part No.938882)		
Battery life	Approx. 3,500 hours		
Operating temperature	0 °C to 40 °C		
Storage temperature	-10 °C to 60 °C		
Dust cover	Part No.450291	Part No.450292	Part No.450290
Scriber	Part No.905200		
Scriber clamp	Part No.05GZA033		

#### ● HDM Series (HDM-12"AX/HDM-18"AX/HDM-24"AX/HDM-40"AX)

Model number	HDM-12"AX	HDM-18"AX	HDM-24"AX	HDM-40"AX
Code No.	192-670-10	192-671-10	192-672-10	192-673-10
Maximum measurement length	300 mm/12"	450 mm/18"	600 mm/24"	1000 mm/40"
Maximum permissible error (E <sub>MPE</sub> )	± 0.02 mm ± 0.001"	± 0.04 mm ± 0.0015"	± 0.04 mm ± 0.0015"	± 0.06 mm ± 0.0025"
Resolution	0.01 mm/0.005 mm/0.0005"/0.0002"			
Maximum response speed	Approx. 500 mm (19.7 in)/s			
Power	SR44 (silver oxide battery) x1 (part No.938882)			
Battery life	Approx. 3,500 hours			
Operating temperature	0 °C to 40 °C			
Storage temperature	-10 °C to 60 °C			
Dust cover	Part No.450291	Part No.450292	Part No.450292	Part No.450290
Scriber	Part No.905201			
Scriber clamp	Part No.901385			

### 2) Output specifications

#### • Data format

(1) Output order (2) All "F" (3) Sign (4) Measured value (5) Decimal point (6) Units

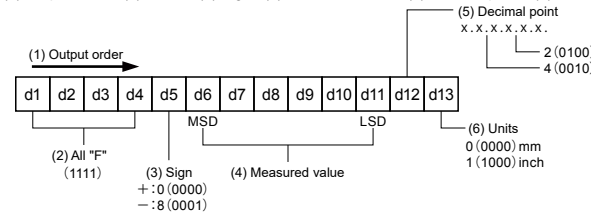

#### Tips

Although there are seven valid digits for 0.005 mm display, the data outputs six digits excluding the 0.005 digit (minimum digit) (Mitutoyo Digimatic output specification: six digits).

Example: Display value of "1000.345 mm" will be printed as "1000.34 mm".

#### • Connector layout

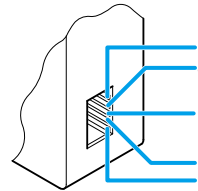

Pin No.	Code
1	GND
2	DATA
3	CLOCK
4	READY
5	REQUEST

#### • Timing chart

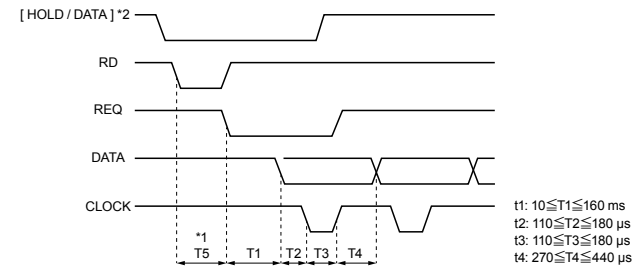

\*1: The time until the [HOLD/DATA] switch goes to the Low level and REQUEST is input.

T5 is determined by the performance of the data processing device.

\*2: Enabled only when the [HOLD/DATA] switch is used.

## 14. Options (Sold Separately)

#### ● Bidirectional touch-trigger probe (HDM Series only)

Allows measurement of steps and inner/outer width, with minimal operator effect.

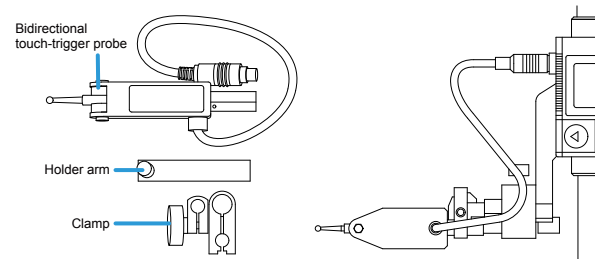

Code No.	Measuring direction	Relay contact type	Probe overtravel (mm)	Probe size (mm)	Repeatability (μm)	Measuring force (N)	Standard accessories
192-007 192-008	Bidirectional	Normally Open	1.5	ø3	σ : 2	0.4	Holder arm, Clamp

#### ● Digimatic connection cable (for IT-016U/IT-007R/DP-1VA LOGGER/MUX-10F/etc.)

1 m: Part No. 905338  
2 m: Part No. 905409

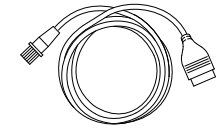

#### ● USB input tool direct

USB-ITN-F (2 m): Part No. 06AFM380F

#### ● U-WAVE-T dedicated connection cable

Standard (160 mm): Part No. 02AZD790F  
Foot switch: Part No. 02AZE140F

#### ● Holder arm

Part No. 953638, 953639

#### ● Clamp

Part No. 900320 (ø6/ø9.5 with dovetail)

\*The holder arm and clamp can be used to attach a test indicator or bidirectional touch-trigger probe.